

THE OFFICIAL GUIDE FROM

NINTENDO
POWER

GAME BOY ADVANCE

METROID

FUSION



THE OFFICIAL
Nintendo
PLAYER'S GUIDE

Staff List

PUBLISHER
T. KIMISHIMA

ASSOCIATE PUBLISHER
YOSHIO TSUBOIKE

EDITOR IN CHIEF
SCOTT PELLAND

SENIOR EDITOR
JESSICA JOFFE STEIN

WRITER
GEORGE SINFIELD

ASSISTANT PRODUCTION
MANAGER
MACHIKO OEHLER

PRODUCTION COORDINATORS
CORINNE AGBUNAG
MAYUMI COLSON

STRATEGIC LAYOUT
U-CRAFT
V-DESIGN, INC.

U-CRAFT
RYUJI HAGINO
TORU NAKAGAWA
NOBUHIRO WATANABE
TATSUYA HOSHI

V-DESIGN, INC.
YOSHI ORIMO
SONJA MORRIS

ART DIRECTOR
KIM LOGAN

SENIOR DESIGNER
JIM CATECHI

DESIGN/PREPRESS
TIM GARRET
REBEKAH LANE
ANDY MYERS
JESSIE SCHUTZENHOFER
DAVID WATERWORTH

PRODUCTION ASSISTANT
CHRISTOPHER SHEPPERD

SALES AND MARKETING MANAGER
JEFF BAFUS

MARKETING SPECIALIST
MALINDA MILLER

The Metroid Fusion Player's Guide is printed in the USA and published by Nintendo of America Inc., 4820 150th Ave. NE, Redmond, Washington 98052 at \$14.99 in the USA (\$17.99 in Canada). ©2002 Nintendo of America Inc. All rights reserved. Nothing that appears in the Metroid Fusion Player's Guide may be printed in whole or in part without express written permission from Nintendo of America Inc., copyright owner. Nintendo is a registered trademark of Nintendo of America Inc. Metroid Fusion ©2002 Nintendo.
ISBN 1-930206-28-3

The cover art for Metroid Fusion features Samus Aran in her blue and red Varia Suit, holding her green Z-Power Beam Rifle. She stands in a dark, industrial environment with various alien creatures. In the upper left, a large, dark, clawed creature with yellow horns is shown. In the lower center, two blue, glowing-eyed creatures are visible. The background includes a control room with a monitor and a large, glowing purple orb. The overall color palette is dominated by blues, purples, and reds.

The Official
Nintendo
Player's Guide

METROID[®]
FUSION

CONTENTS

METROID HISTORY	4
TAKE ACTION	6
STATION NAVIGATION	12
ENEMY ELIMINATION	15
MAXIMIZE POWER	16

X ADVENTURE

Parasites are taking over the Biologic Labs Research Station. As you battle the parasite population and fight to regain Samus's abilities, you will

visit every station sector multiple times. Our strategy coverage follows your logical progression through the sectors.

MAIN DECK	18
SECTOR 1	22
SECTOR 2	28
SECTOR 4	34
SECTOR 3	40
SECTOR 6	46
SECTOR 5	52
SECTOR 3	58
MAIN DECK	62
SECTOR 5	66

MAIN DECK	70
SECTOR 2	76
SECTOR 5	80
SECTOR 4	84
SECTOR 6	90
RESTRICTED ZONE	94
SECTOR 1	96
MAIN DECK	102
QUEST FOR PERFECTION	104

TANK TRIALS

MAIN DECK	106
SECTOR 1	108
SECTOR 2	110
SECTOR 3	112
SECTOR 4	114
SECTOR 5	116
SECTOR 6	118
RESTRICTED ZONE	120

METROID HISTORY

While Samus Aran made her debut in the late 1980s, 2002 has been her best year to date. Her three earlier games span three Nintendo systems.



METROID (1987)

Released in 1986 for the Japanese Famicom system, Metroid made it to the original Nintendo Entertainment System (NES) in 1987. It is one of the first games ever to use a password for saving progress and establishes a game play style that emphasizes athletic moves and open exploration. Samus Aran's original arsenal features the now classic Screw Attack and Varia Suit, along with the player's choice of the freezing Ice Beam or the powerful but unpredictable Wave Beam. The story follows the discovery of the deadly Metroid species and Samus's first battles with Kraid, Ridley and Mother Brain on the planet Zebes. Samus's identity is masked throughout the adventure. Only the game's best endings reveal that she is a woman.

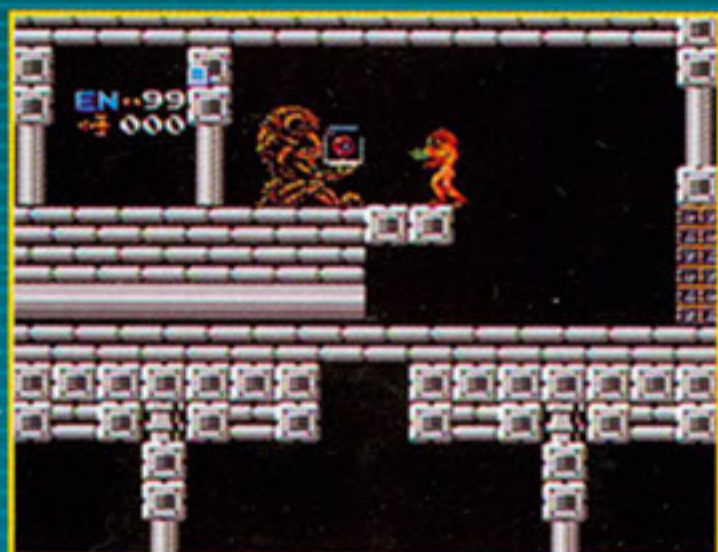

METROID II: RETURN OF SAMUS (1991)

The Game Boy debut of the Metroid series is twice the size of the original game and one of the first Game Boy games with battery backup. In the adventure, Samus visits SR388, the Metroids' home planet, to investigate rumors that the Metroids are growing in size and number. As always, Samus is the human race's first and last line of defense when it comes to eradicating the Metroid menace. The game introduces different types of Metroids, such as the Gamma Metroid, Omega Metroid and the all-powerful Queen Metroid. Along with the Metroid population, Samus's choice of weapons grows, too. Among the new items are the Spring Ball, which allows Samus to jump in ball form, and the Spider Ball, which gives Samus the ability to stick to walls and ceilings.

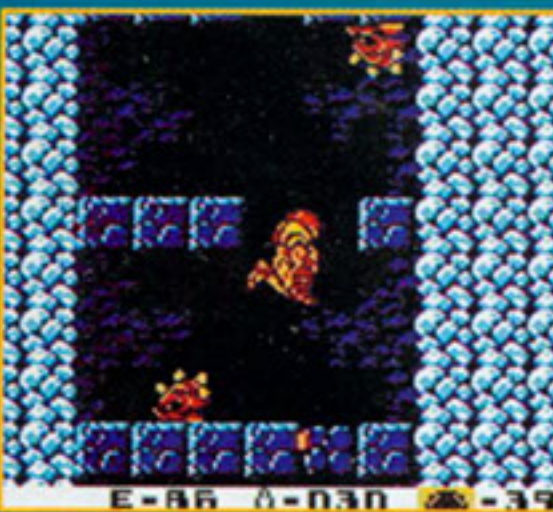

SUPER METROID (1994)

The incredible story of Samus Aran continues in a 24-Megabit Super NES adventure that far exceeds the size and scope of the previous Metroid games. Samus returns to the planet Zebes to discover a wide variety of habitats, acid rain, Chozo Statues and, of course, Kraid, Ridley and Mother Brain. The game marks the debut of

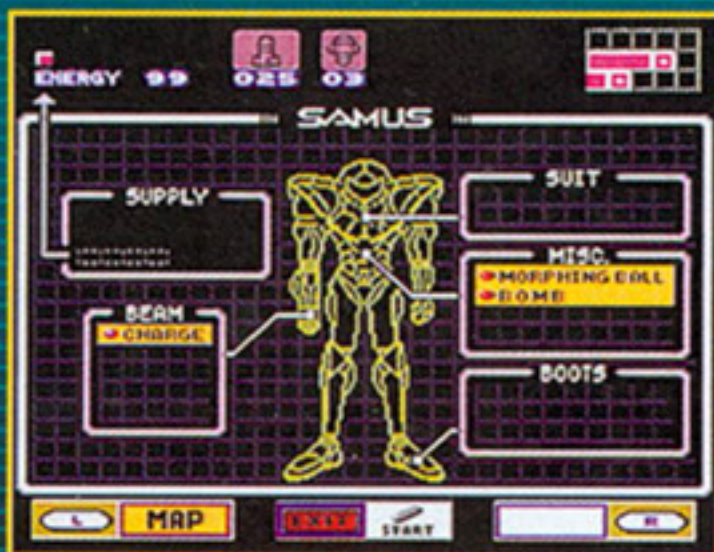

the Gravity Suit, the Speed Booster and the Grappling Beam—part of an arsenal of five Beam types, two Missile types, two Bomb types and 11 space suit attachments. Samus uses the Grappling Beam to great effect in the Super Smash Bros. games.



METROID PRIME (2002)

The simultaneous Metroid Prime for Nintendo GameCube release with Metroid Fusion breaks from the established Metroid style by showing the action from the eyes of Samus Aran. For the first time, you can see through Samus's visor, scan objects in the environment and even detect the thermal signatures of enemies. The game sticks with Metroid tradition by presenting a world full of secret items and hidden passages that Samus finds by using her Power Suit abilities. They include the Spider Ball and Grapple Beam.



TAKE ACTION

Samus begins the game stripped of her most powerful abilities, but she can still prove her mettle against the X parasites. As you guide her through the research station, you'll tap every function her suit and weapons have to offer.



BASIC CONTROLS



RUN

Samus doesn't walk—she runs from one challenge to the next. Press Left or Right on the Control Pad and watch her go. Samus also moves laterally in the air when you press Left or Right. Once you collect the Speed Booster (see page 11), you'll be able to make Samus run so fast that she'll blast through some barriers.

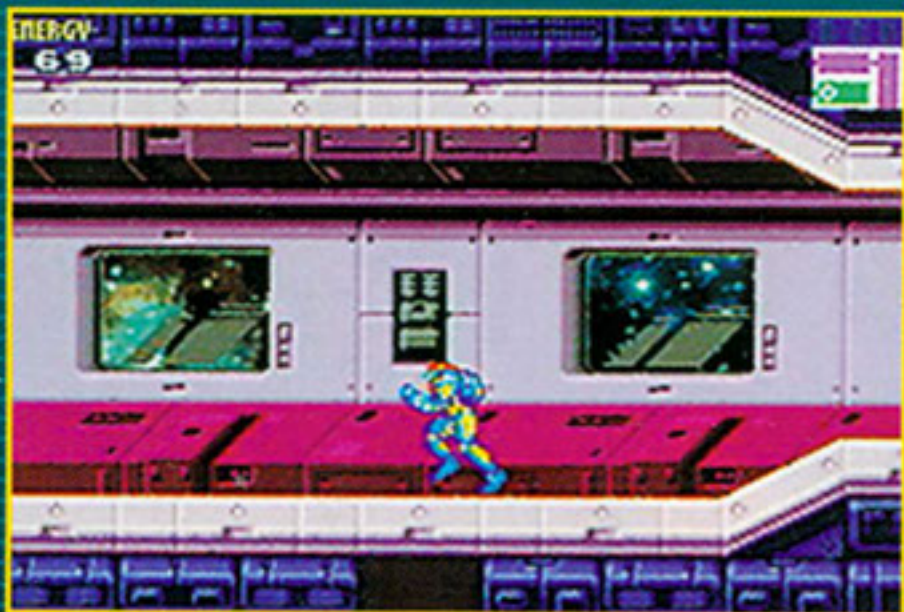

Samus Aran is an adventurer on the run. Press Left or Right to make her move.

CROUCH

While you won't be able to make Samus morph into a ball at the beginning of the adventure, you will be able to make her crouch by pressing Down on the Control Pad. A quick crouch is good for avoiding high enemy attacks and firing on creatures that are low to the ground.



Think fast and crouch when enemies aim at Samus's upper body. The shot will pass harmlessly over her head.

JUMP

If you want to cross wide gaps or reach high platforms, you'll have to perfect the art of jumping. The longer you hold the A Button, the longer Samus will stay in the air. Press Left or Right on the Control Pad to make her execute a Spin Jump. If you reverse the direction of a Spin Jump as soon as Samus hits a wall then quickly press the A Button again, she'll jump off the wall and double the height of her leap.

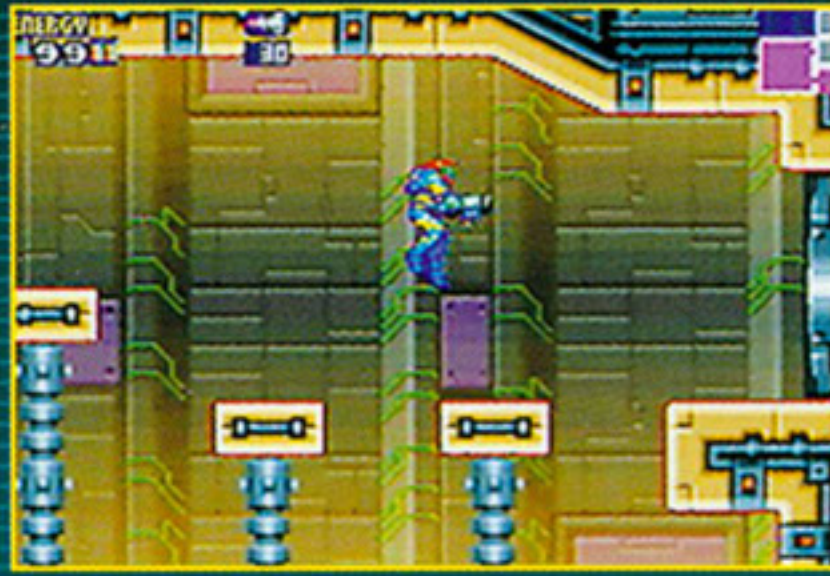

FIRE A BEAM

You can fire Samus's Beam in eight directions. Press Up on the Control Pad to aim upward. Press Down while Samus is in the air to aim toward the ground. Press the L Button to aim diagonally upward and press L and Down to aim diagonally downward. Then press the A Button quickly and repeatedly to release a blaster barrage.



PUT IT ALL TOGETHER

When surgeons removed parts of Samus's Power Suit in an effort to save her life and gave her the Fusion Suit, they also took away most of her special abilities. You can help Samus regain her abilities by downloading information from the research station's Data Rooms and by defeating the Core-X creatures that haunt the station's halls. With her abilities restored, Samus will be ready in no time to take on bounty hunter impersonator SA-X.

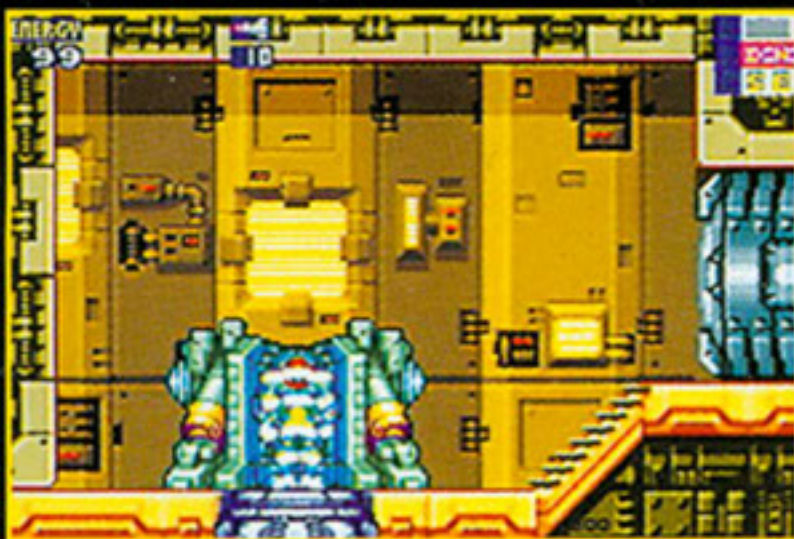

Seek out Data Rooms (marked with a "D" on the map) to download special abilities. The first Data Room will give you Missiles.

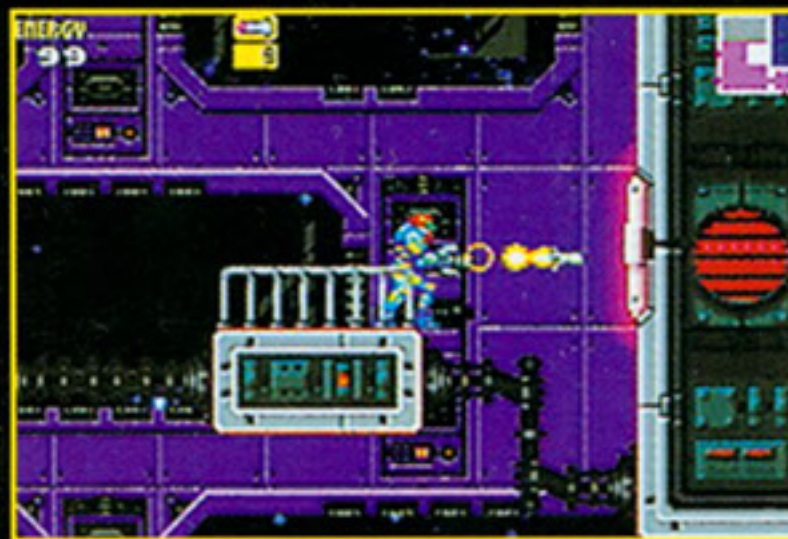

As soon as Samus has her advanced abilities, you'll have her use them to access more areas of the research station.



FUSION SUIT ABILITIES

The elite adventurer needs advanced abilities to take on the ever-increasing challenges of space station exploration. Samus's advanced Beams, Missiles and Bombs help her defeat creatures and blast through obstacles, and her suits and miscellaneous abilities give her the power to navigate the station's harsh environments.

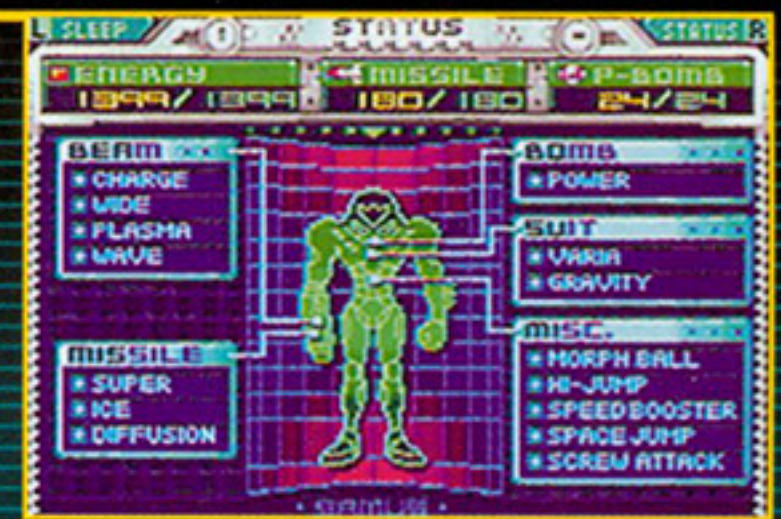

BEAMS

CHARGE BEAM

Not only is the Charge Beam naturally more powerful than Samus's standard Beam, but it gains power when you press and hold the A Button to charge it. You can also charge up the Plasma, Wave and Wide Beams. When Samus's beam is fully charged, you can damage most enemies by Spin-Jumping into them.



The Charge Beam is more powerful and larger than Samus's standard Beam weapon.

LOCATION

Sector 1
(page 27)

PLASMA BEAM

The Plasma Beam's three lasers cut through enemies and keep on going, so you can hit several creatures with a single shot. It is particularly helpful when small armies of X-infected creatures swarm in on the space adventurer. A few Plasma Beam shots in all directions will keep the enemies at bay.



Use the Plasma Beam to clear your way through the space station. Like all beams, it opens flashing hatches.

LOCATION

Sector 2
(page 79)

WIDE BEAM

Three shots fly from Samus's blaster at three different angles when you use the Wide Beam. The weapon is particularly effective when swarms of weak enemies are attacking or when you are firing on enemies from a distance. The Wide Beam doesn't have the overwhelming power of other advanced weapons, but it does have a shot-spreading, buckshot quality.



The Wide Beam releases three shots that spread out and hit a large area.

LOCATION

Sector 3
(page 61)

WAVE BEAM

The strongest beam in Samus's arsenal sends out three undulating shots. The weapon's electric pulses allow it to pass through most obstacles, hitting targets on the other side. By using the Wave Beam, you will be able to defeat enemies in other areas before you even enter them. That just doesn't seem fair.



Samus's Wave Beam defeats enemies with the power of a tsunami.

LOCATION

Sector 6
(page 93)

MISSILES

MISSILE

The first of Samus's abilities that you will recover while exploring the research station is the power to fire Missiles. Press and hold the R Button to ready the Missile launcher, then press A to fire. Your Missile-holding capacity will increase by five every time you collect a Missile Tank. Collect green X organisms to replenish your supply.

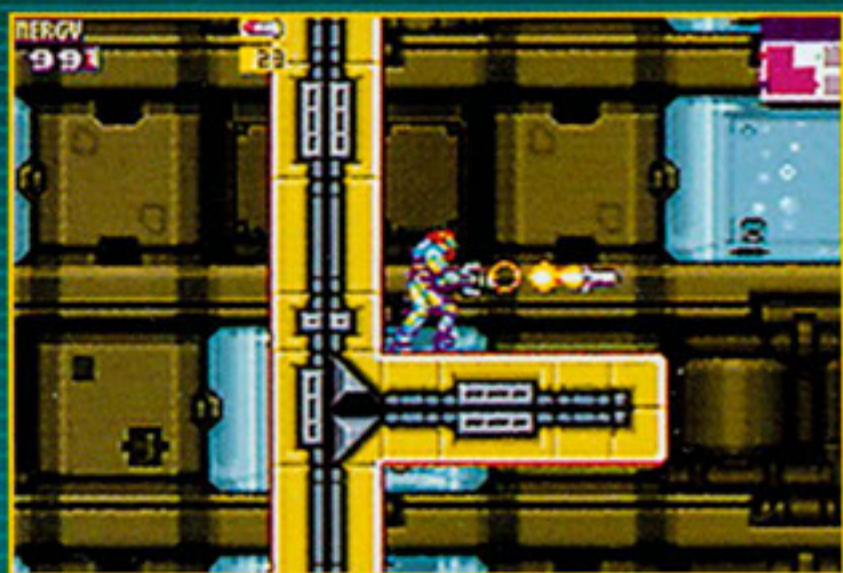

Unlike Beam power, your Missile supply is limited. Collect and conserve Missiles if you're running low.



Most bosses have large X parasites at their core. The only way to damage the creatures is with loads of Missiles.

LOCATION
Main Deck
(page 20)

ICE MISSILE

You can use some enemies as stepping-stones to reach out-of-the-way areas. Before you can step onto them, you must freeze them with an Ice Missile. A single Ice Missile shot will stop an enemy in its tracks for several seconds. Hit the creature, jump onto it while it's frozen, then move before it thaws out.



An Ice Missile detonation freezes most enemies momentarily. That's your cue to use them for a boost.

LOCATION
Sector 5
(page 56)

DIFFUSION MISSILE

Diffusion Missiles can power up, much like the Charge Beam. Press and hold the R Button to charge a Diffusion Missile, then press B to launch it when it's at full power. The Missile's detonation will destroy or freeze all of the X parasites within a wide blast radius. It's the perfect weapon for dealing with large groups of enemies in a hurry.



Charge up a Diffusion Missile then aim it into the middle of a group of enemies.

SUPER MISSILE

Screen-shaking Super Missiles pack a much stronger wallop than Samus's standard Missiles. You'll be able to destroy the eyeball-like guardians that cover some hatches with a single Super Missile hit, when it would require three standard Missiles to do the same job before your Missile upgrade.



Super Missiles are about three times as powerful as standard Missiles. You'll cause a lot of damage with them in your arsenal.

LOCATION
Sector 3
(page 44)

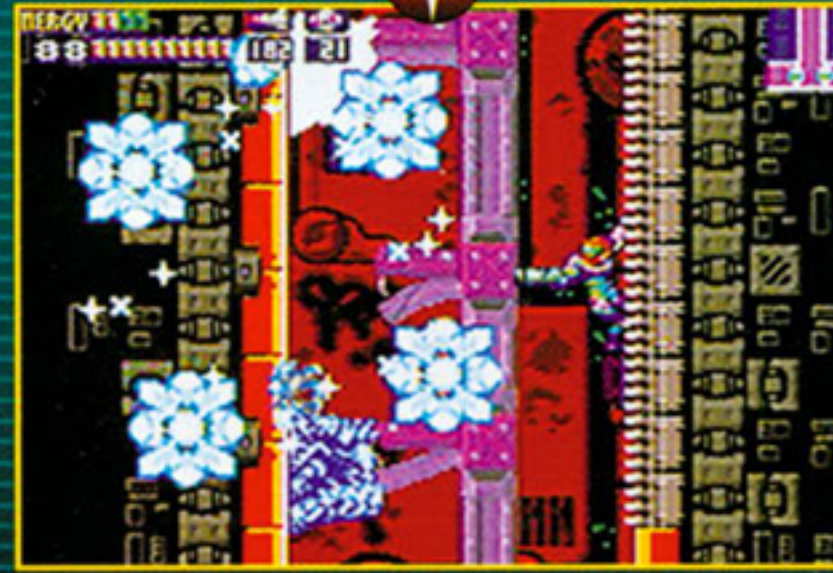

The Missile's blast will destroy or freeze every creature within its range.

LOCATION
Sector 4
(page 89)

BOMBS

BOMB

Samus Aran's versatility makes her a great warrior. As soon as she regains the Bomb ability, you can set a Bomb by rolling up into the Morph Ball form and pressing the B Button. The Bomb will detonate in a matter of seconds. You can set as many Bombs as you wish and use them to blast through some blocks in the walls and floors.

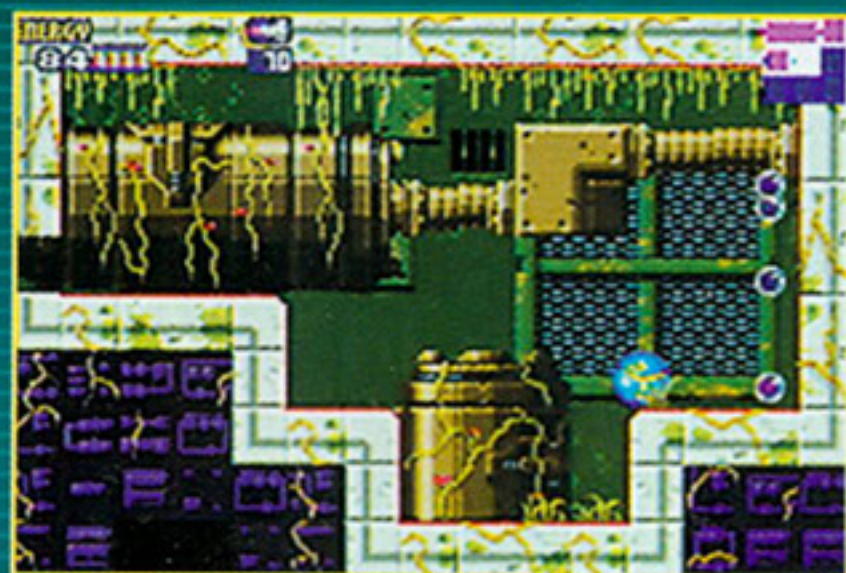

Bomb blasts break through Bomb Blocks. You can also use blasts to propel Samus into the air in Morph Ball form.

LOCATION

Sector 2
(page 30)

POWER BOMB

The explosive power of Samus's advanced Bombs damages all enemies and disintegrates all susceptible obstacles on the screen. It also destroys some blocks that are strong enough to withstand the power of a normal Bomb blast. Samus's supply of Power Bombs is limited. Conserve them.



A Power Bomb blast damages every block and creature in the room that a normal Bomb can damage.

LOCATION

Sector 5
(page 68)

SUITS

VARIA SUIT

If Samus steps into a hot or cold environment in her Fusion Suit, she'll lose energy at a steady rate. She'll also be vulnerable to damage from icy enemies and the SA-X creature's Ice Beam. The Varia Suit puts an end to Samus's temperature sensitivity. It also shields Samus from enemy attacks more effectively.



Hot and cold temperatures won't affect Samus once she has the Varia Suit.

LOCATION

Sector 6
(page 51)

GRAVITY SUIT

Samus's most versatile suit allows her to move quickly and freely and perform her special moves in water. It also provides protection from the damaging effects of lava and reduces the amount of damage that enemies can cause her. The Gravity Suit is required equipment for exploration in the most dangerous sections of the research station.

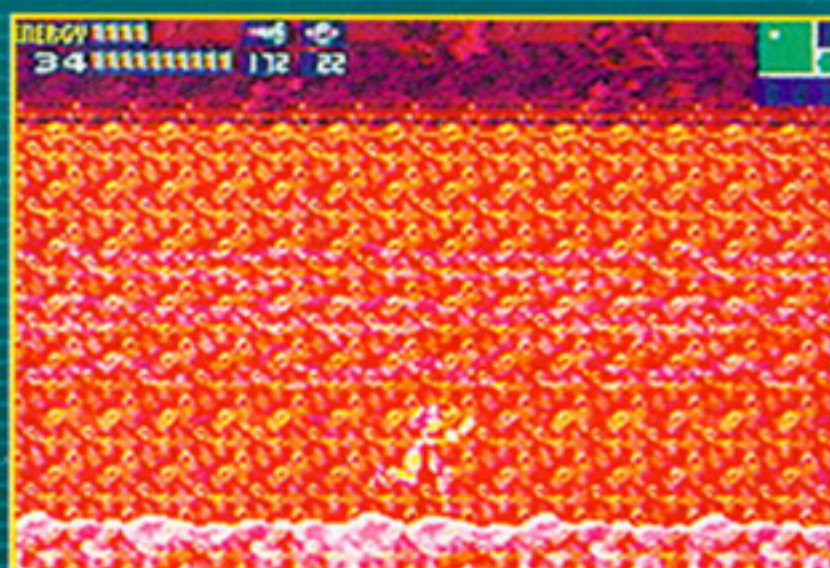

When Samus has the Gravity Suit, lava no longer causes damage.

LOCATION

Sector 5
(page 83)

OTHER MOVES

MORPH BALL

Some tunnels are much too narrow for Samus to run through. When you earn the Morph Ball ability, press Down on the Control Pad twice, or press Up when Samus is hanging from a ledge, to make her roll up into a small ball—perfect for narrow tunnel or pipe navigation.

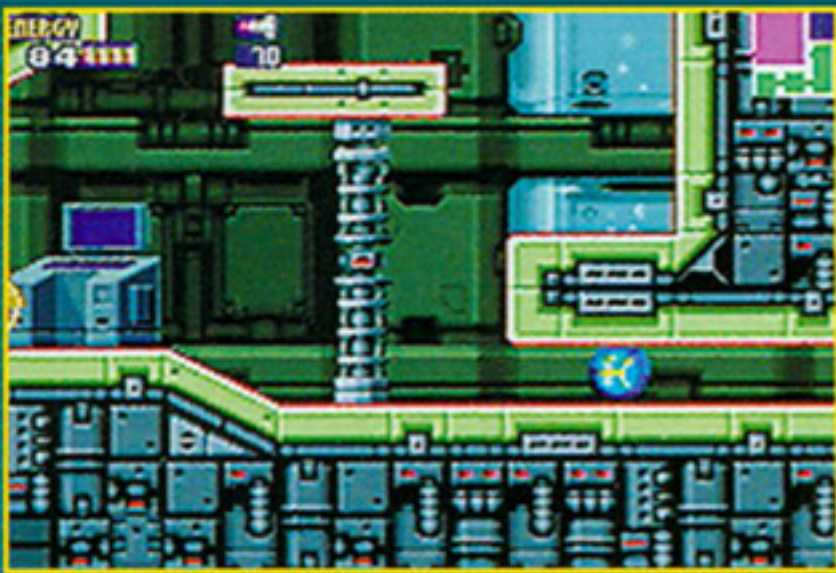

Press Left or Right on the Control Pad to roll when Samus is in Morph Ball form.

LOCATION

Main Deck
(page 21)

SPACE JUMP

If you want to guide Samus to the top of a vertical area without the benefit of a ladder or elevator, you must perfect the Space Jump. With the Space Jump ability, Samus can jump several times successively while spinning in the air.



Use the Control Pad to steer Samus, and press A repeatedly to execute successive Space Jumps.

LOCATION

Main Deck
(page 74)

HI-JUMP

Samus will earn two abilities at one time during her first visit to Sector 2. The Hi-Jump allows her to jump much higher than before and jump in her Morph Ball form. With it, you can explore many otherwise unreachable areas.



The Hi-Jump ability gives Samus much greater maneuverability in tight places.

LOCATION

Sector 2
(page 32)

SCREW ATTACK

Samus's signature move is the Screw Attack, which turns her into an invincible buzz saw of a bounty hunter while she is spinning through the air. It's a more powerful and reliable version of the charged Beam jump.



After Samus collects the Screw Attack, she'll finally be able to equal the power of the SA-X.

LOCATION

Sector 1
(page 100)

SPEED BOOSTER

When you detonate a Bomb near some barriers, they will expose a Boost Block. Samus can run through Boost Blocks with the power of her Speed Booster. Give Samus a long running start to let her booster charge up. When she's glowing, she'll be able to run through the blocks. If you press Down to stop and crouch when the Speed Booster is fully charged, you'll execute a rocket launch jump, which you can angle in any direction.

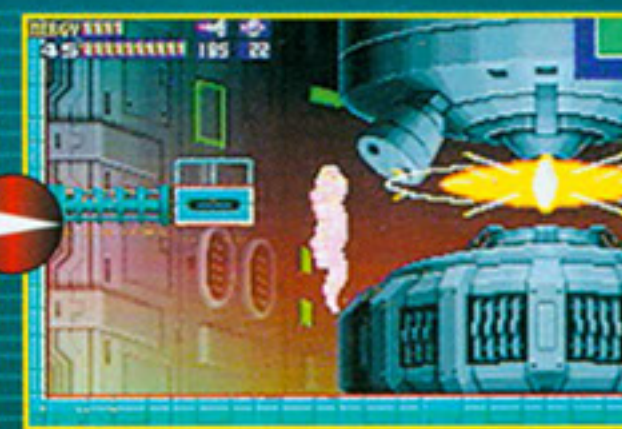
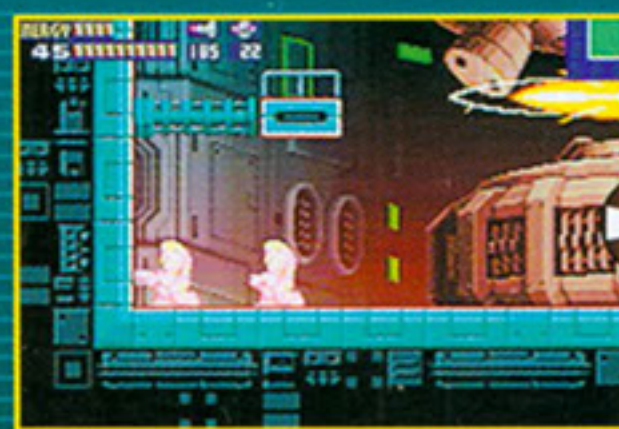

LOCATION

Sector 4
(page 38)

If she gets a long running start, Samus will become blurringly fast and temporarily invincible.

STATION NAVIGATION

Your success against the X parasites depends on your ability to guide Samus through the dangerous corridors of the research station. It's important to watch all of the screen information and mission parameters as you explore.



SCREEN DATA

ENERGY

The energy indicator shows how much energy remains in reserve. If all energy is depleted, the mission will be aborted.

ENERGY TANKS

Small boxes next to the energy indicator show how many Energy Tanks you have collected. Each one holds 100 reserve units.

MISSILES

The Missile indicator shows your current number of Missiles. Your Missile-carrying capacity will increase as you collect Missile Tanks.

CURRENT SECTOR

The name of the sector that you are currently exploring is shown at the top of the map screen.

MAP

The shaded parts on each area's map show places that you have already explored. Green-colored rooms did not appear on the area's original map.

N Navigation Room

S Save Room

R Recharge Room

D Data Room

T Elevator

• Former Tank Location

○ Current Tank Location

⊠ Boss Battle Location

MAP

A small map showing rooms in the immediate area appears in the upper-right corner of the main screen.

POWER BOMB

The Power Bomb indicator shows the current number of Power Bombs in reserve.

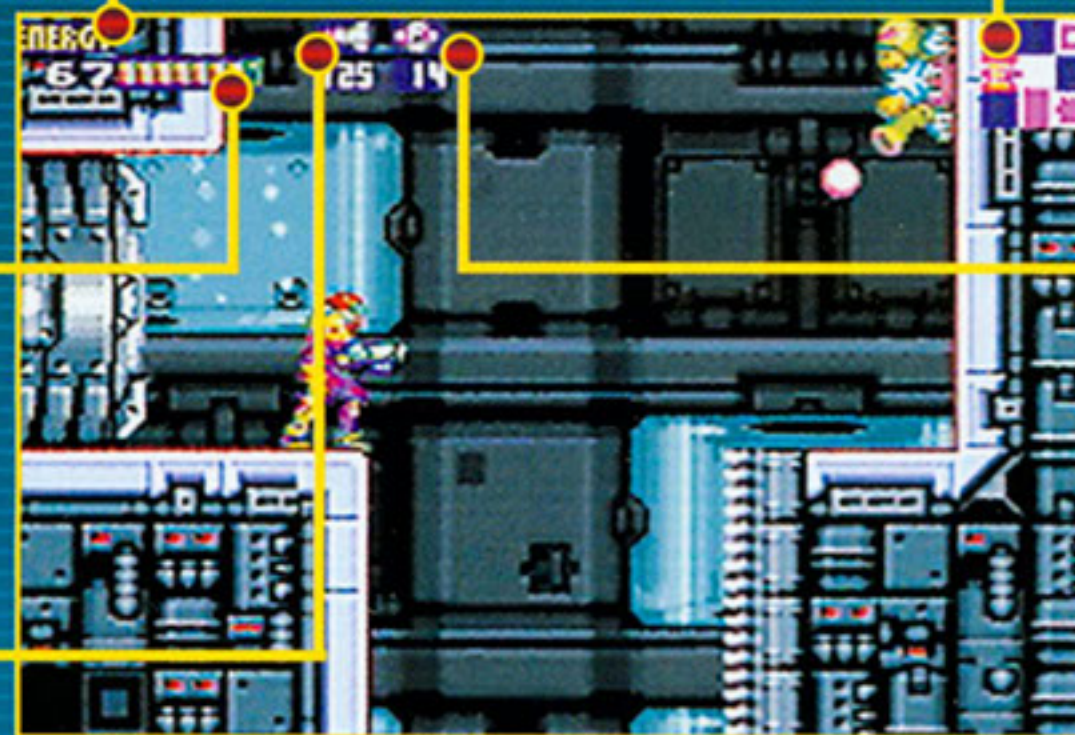

MAIN SCREEN

PRESS START



MAP SCREEN

OBJECTIVE

While you're viewing the map, you can also look at the current mission objective by pressing the A Button.

STATUS SCREEN

Press the R Button to switch to Samus's status screen for a full view of the explorer's abilities, energy, Missiles and Power Bombs.



HATCH INFORMATION

The status of the Security Hatches —locked or open—is shown in the upper-right corner. You'll unlock the hatches by finding Security Rooms.

UNCOVER OBJECTIVES

You must guide Samus to Navigation Rooms to update mission objectives. She will not be able to leave the current sector until she has completed the mission objectives for the sector. Once the objectives are met, you can get the next set of instructions in any Navigation Room. Mission instructions usually cover information about the target and a target location that appears on the map.

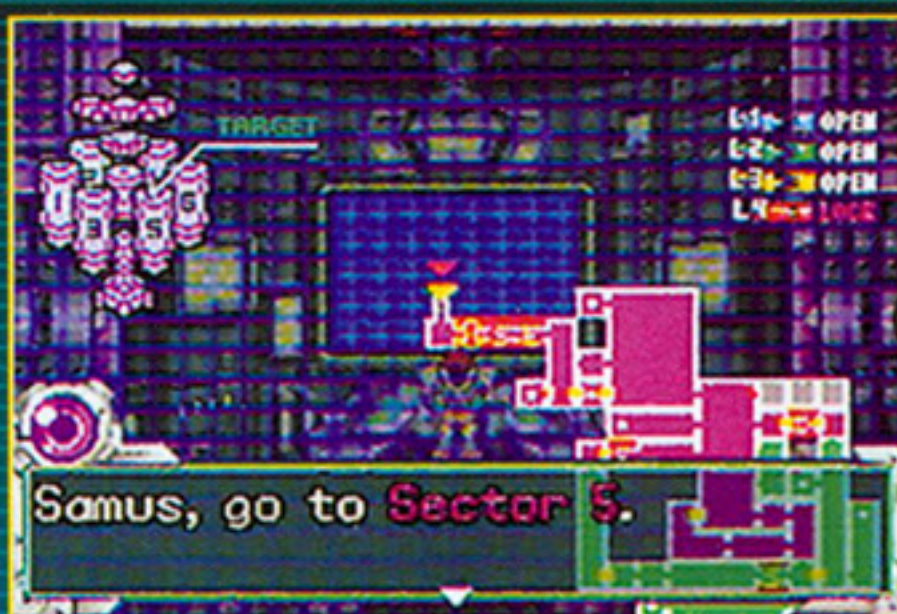

Your ship's computer gives you mission objective information in Navigation Rooms.

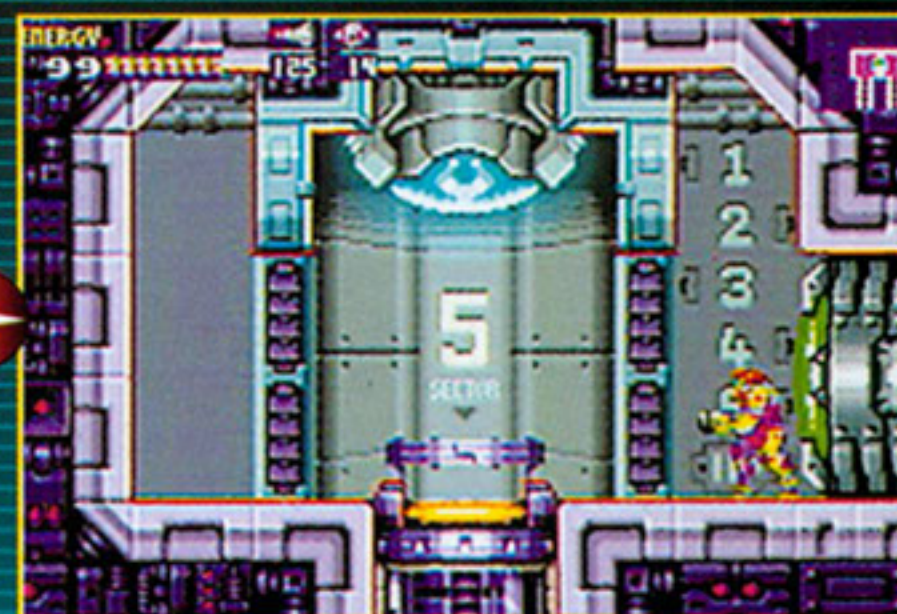

After you've received the information, you can move on to the next set of challenges and continue the fight against the parasites.

EXPLORE THE AREA

The first time you enter a sector, you will download map information for the area in a Navigation Room. The map shows all known corridors. As you explore the sector and find new, unknown areas, they will appear on the map. You'll find passages to unknown areas by using Samus's special abilities.

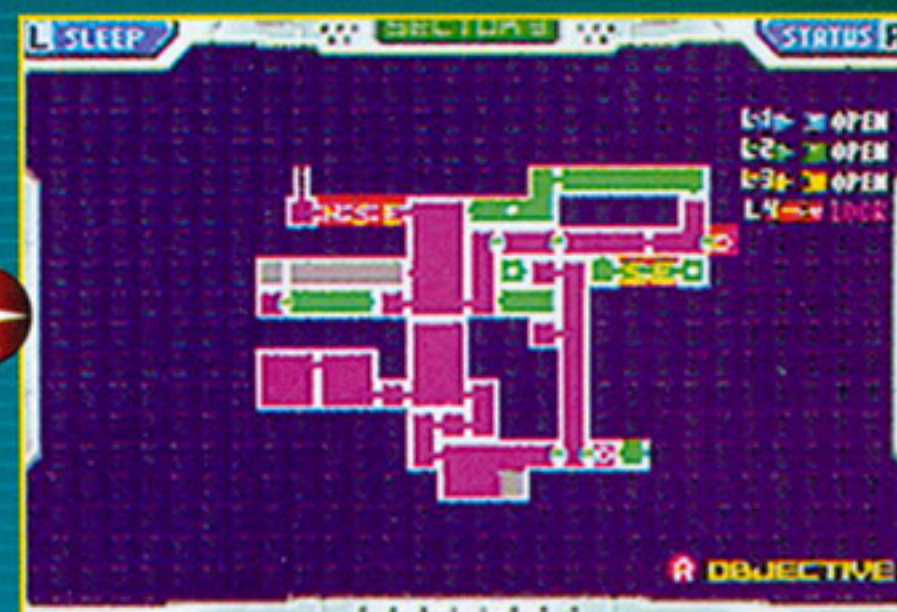
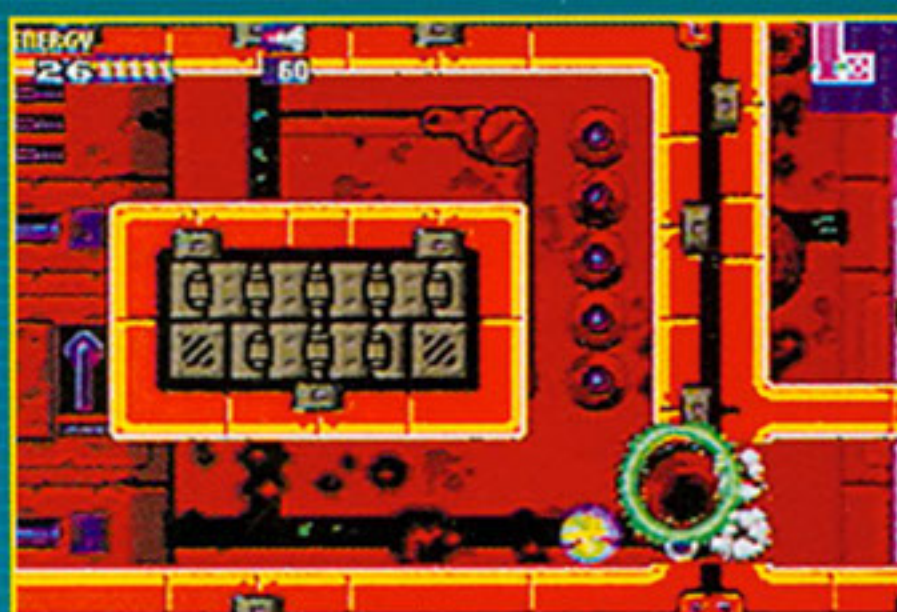

COMPUTER CONNECTIONS

You'll discover rooms in each sector where you can make a connection with your ship's computer. Each of five different computer connections performs a different type of function, from saving game data to recharging energy and replenishing your weapon supply. All room locations, except for Security Room locations, are shown on the map. If you're about to explore an unknown territory, it pays to save and recharge first.

S Save Room

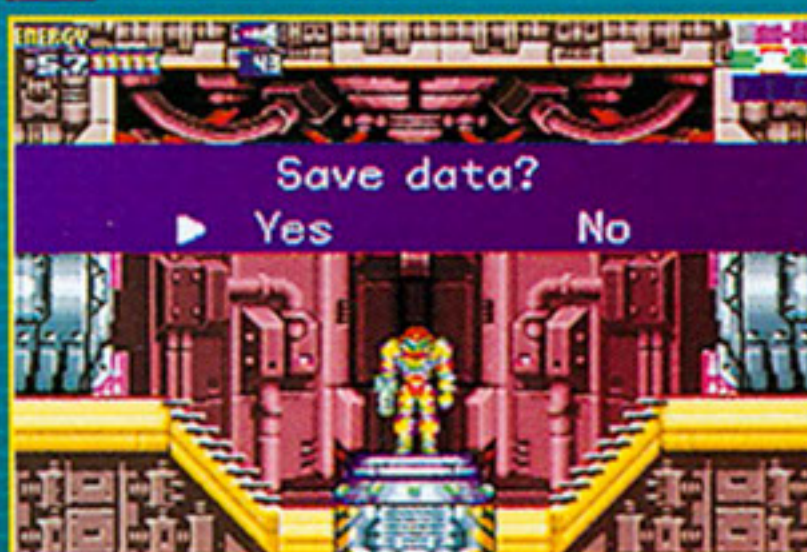

You can save mission data in Save Rooms. If you lose all energy reserves, you'll start over at the last Save Room.

D Data Room



Samus will recover her lost abilities in Data Rooms, unless a Core-X creature has beaten her to it.

N Navigation Room



Your ship's computer offers map information and mission objectives in the station's all-important Navigation Rooms.

R Recharge Room



Shown on the map with the letter "R" (for "recharge"), Recharge Rooms replenish all of Samus's energy and weapons.

Security Room



The unmarked Security Rooms unlock the station's Security Hatches. The hatches will flash to show that they are unlocked.

ON THE MOVE

Even without all of her Power Suit abilities, Samus is a capable athlete and fearless adventurer. She can run fast, jump far, climb ladders, and grab onto ledges and pull herself up. As you guide Samus through the research station, you should experiment with different move combinations. Once you learn new abilities, try to use them everywhere. You'll likely discover new passages that lead to special items or shortcuts.

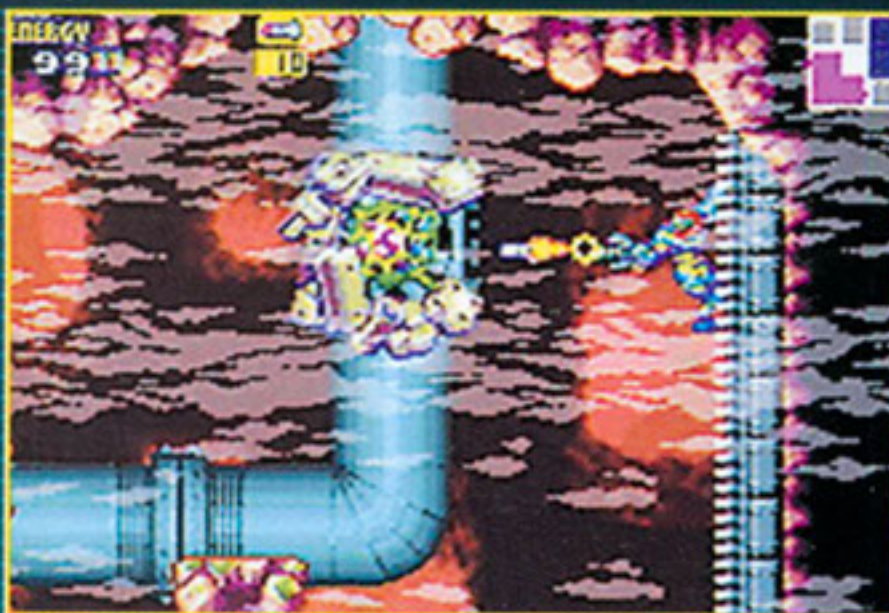

Samus exhibits her versatility by using moves in combination, such as holding onto a ladder and firing her weapons at the same time.



Even if a platform or a ledge looks like it's out of reach, Samus may be able to grab it with a long leap and pull herself up.

HOSTILE ENVIRONMENTS

Electrically charged water, lava and freezing air make some research station environments extremely dangerous. If Samus is not equipped with the Varia Suit or the Gravity Suit, she will lose energy at a steady rate in hostile habitats. It's best to stay away from damaging environments until Samus has downloaded the appropriate protective suit data.



BREAK BARRIERS

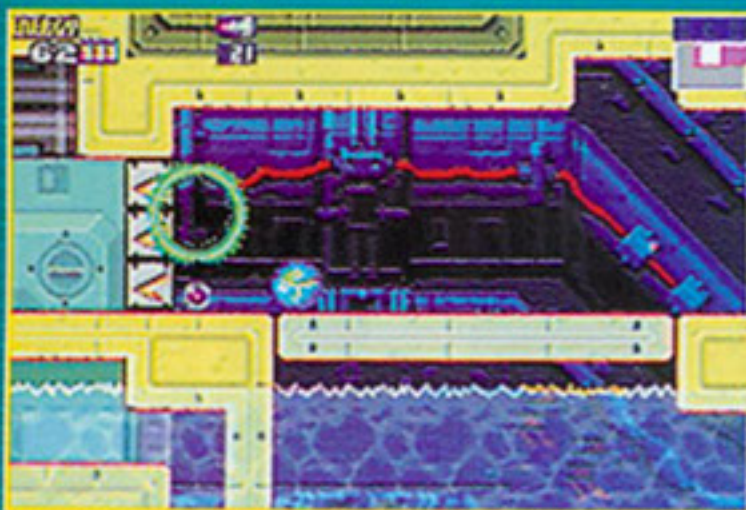

You can break through blocks with Samus's large collection of items and abilities. Expose the block types by hitting them with Bomb blasts.

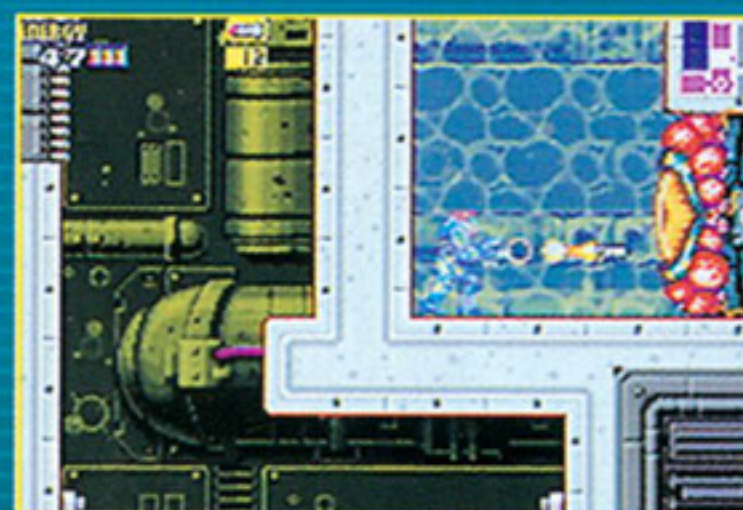

You'll unlock some hatches by making computer connections at the appropriate Security Rooms. You'll have to try different methods to unlock other hatches or doors.

BLOCKS

 Bomb Block	Destroy with Bombs.
 Fake Block	Fall through weak blocks in the ground.
 Missile Block	Destroy with Missiles.
 Power Bomb Block	Destroy with Power Bombs.
 Dash Block	Destroy with a Speed Booster run.
 Screw Attack Block	Destroy with the Screw Attack.

HATCHES

 Gray Hatch	Unlock Level 0 security.
 Blue Hatch	Unlock Level 1 security.
 Green Hatch	Unlock Level 2 security.
 Yellow Hatch	Unlock Level 3 security.
 Red Hatch	Unlock Level 4 security.
 Special Hatch	Fulfill special conditions.
 Shutter	Blast the switches with your Beam.

ENEMY ELIMINATION

The X parasites have spread through every sector and corridor of the research station. They can take on the forms of dangerous creatures and plants. You must destroy the shells of the creatures then collect the exposed parasites.

AIM AND FIRE

Some enemies can charge and attack very quickly. You often have only a moment to aim and fire before the creatures surround you. Try to line up a straight shot by crouching, jumping or firing at an angle, then hit the creatures with as much firepower as you need to get the job done. As you explore the environment and take on increasingly dangerous groups of enemies, you will master the art of quick and accurate weapon release.



Some enemies crawl low to the ground. You can take them out by crouching and firing.



Approach creatures cautiously and work out a good angle to fire from a distance.

Some enemies are impervious to the standard Beam blast. You may need more lethal firepower, such as a Charged Beam or Missile, to damage them. Other enemies are protected by armor. You will be able to hurt them only if you expose their Achilles' heels. Experiment with every new species and find a way to wipe them out. Once you have a species figured out, you'll be able to defeat every creature of the species in the same way.



Charged Beams are effective against particularly strong enemies. Missiles also damage more protected creatures.



Some enemies, such as the upright walking Space Pirates, have weak spots. You'll damage them only if you hit them from behind.

X COLLECTION

Once you've exposed the X parasites, you can grab them to recover energy, weapons or abilities. Yellow parasites refill 10 energy units. Green ones give you two Missiles. By collecting red parasites—the kind that you find after you destroy a hatch guardian—you can replenish energy, Missiles and Power Bombs. When you defeat and collect Core-X parasites, you will recover one of Samus Aran's lost abilities.

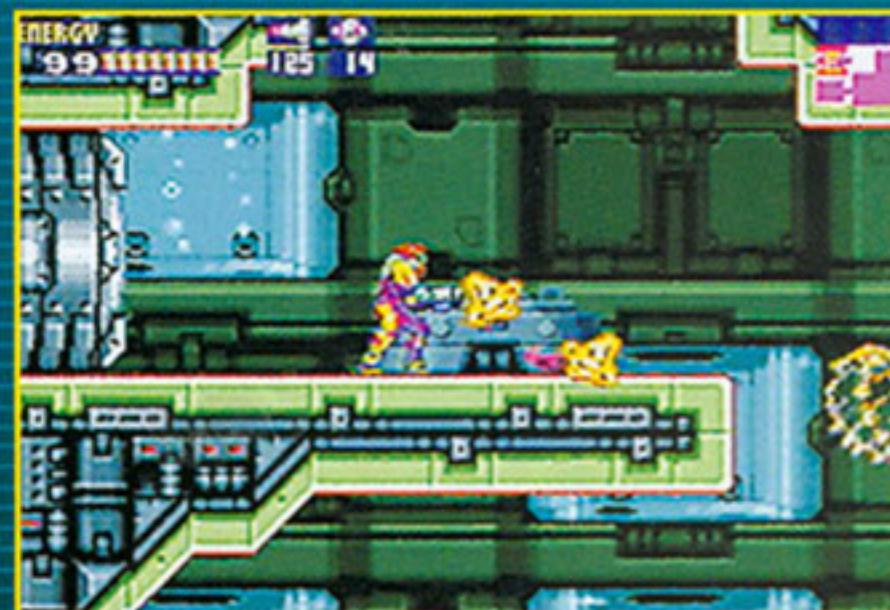

A special Metroid vaccine in Samus's body allows her to replenish energy and weapons by collecting parasites.



While you're fighting a Core-X creature, it will shed X parasites. Collect them to refill your energy midbattle.

MAXIMIZE POWER

By collecting tanks, you can increase Samus's capacity to hold energy, Missiles and Power Bombs. Every tank contributes to her overall strength.



TAKE THE TANKS

Tanks are important discoveries. Without them, you will not be able to hold your own in difficult situations. Seek out all three types of tanks, but beware of fake tanks that come to life and attack. There are 20 Energy Tanks, 48 Missile Tanks and 32 Power Bomb Tanks scattered throughout the research station.



POWER BOMB TANK

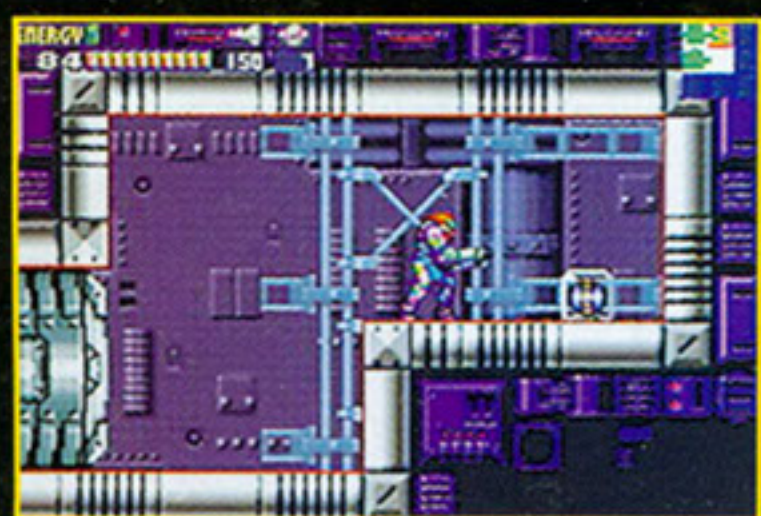

Every Power Bomb Tank that you collect will allow Samus to carry two more of the damage-spreading devices.

MISSILE TANK



Every Missile Tank gives Samus additional carrying capacity for five Missiles.

ENERGY TANK

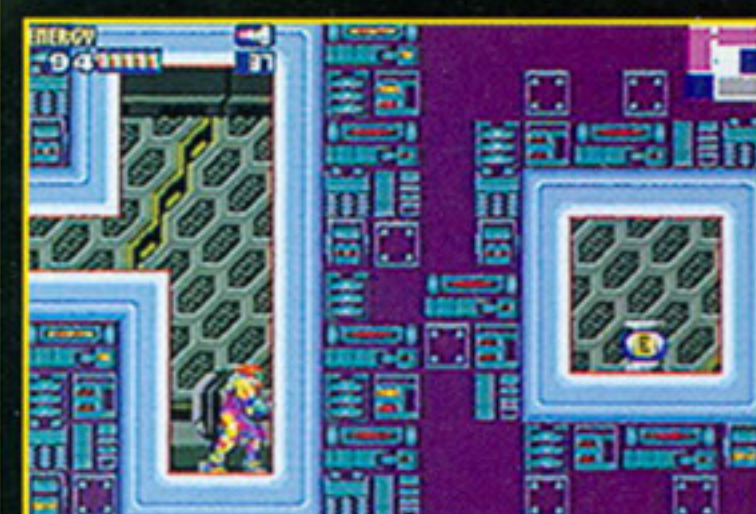

Highly coveted—and difficult to acquire—Energy Tanks give Samus the ability to hold 100 more energy units.

OFF THE BEATEN PATH

You'll have to use all of Samus's special abilities and explore every area to find tanks. Most tanks are in dangerous dead ends or hidden passages. Identify and break through barriers and enter the station's little known areas. You'll discover a wealth of helpful items. See the Tank Trials section on page 106 for strategies on getting every tank.

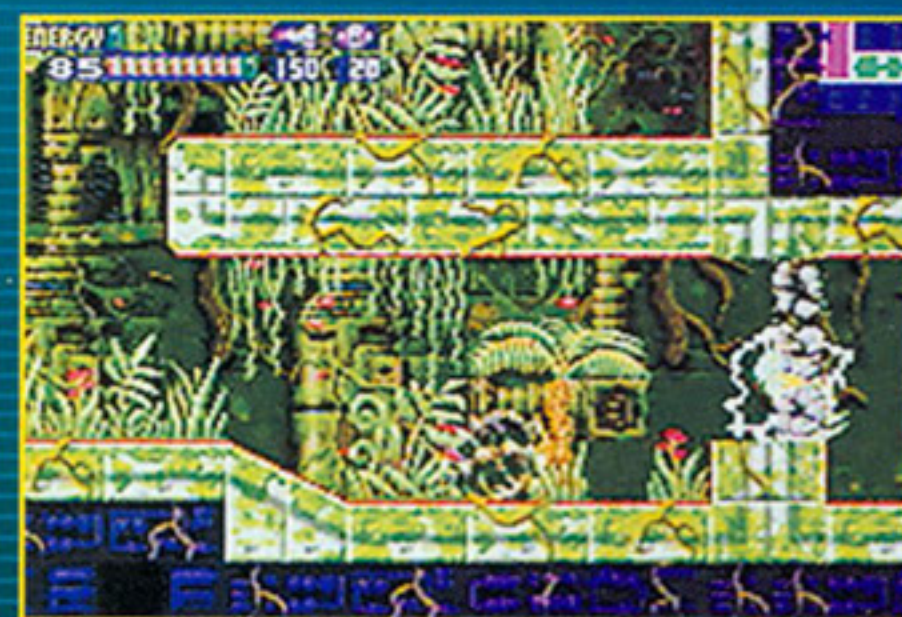
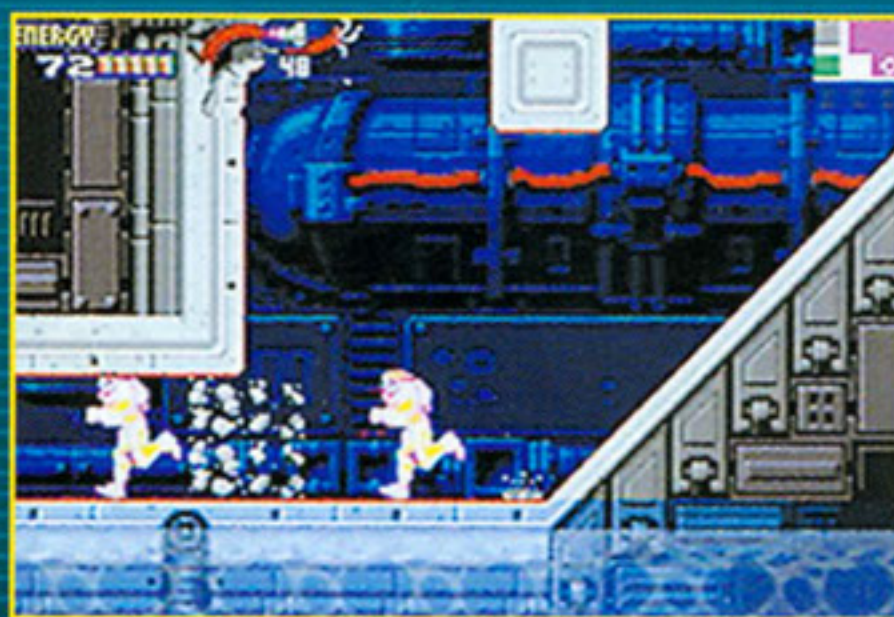



X Adventure

MAIN DECK

The mystery of the X parasites is foremost in Samus's mind when she sinks deep into the dark corridors of the abandoned research station.





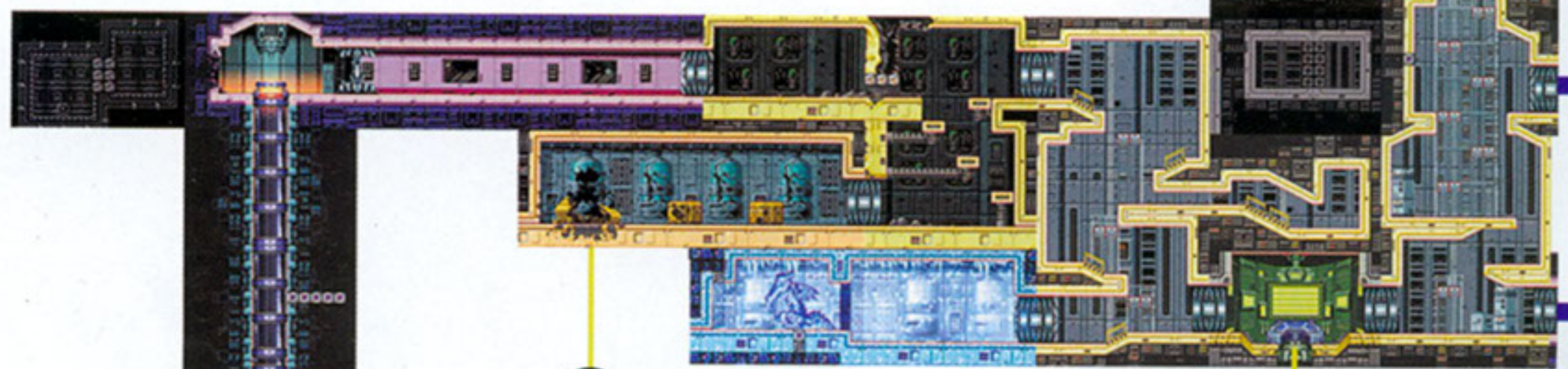
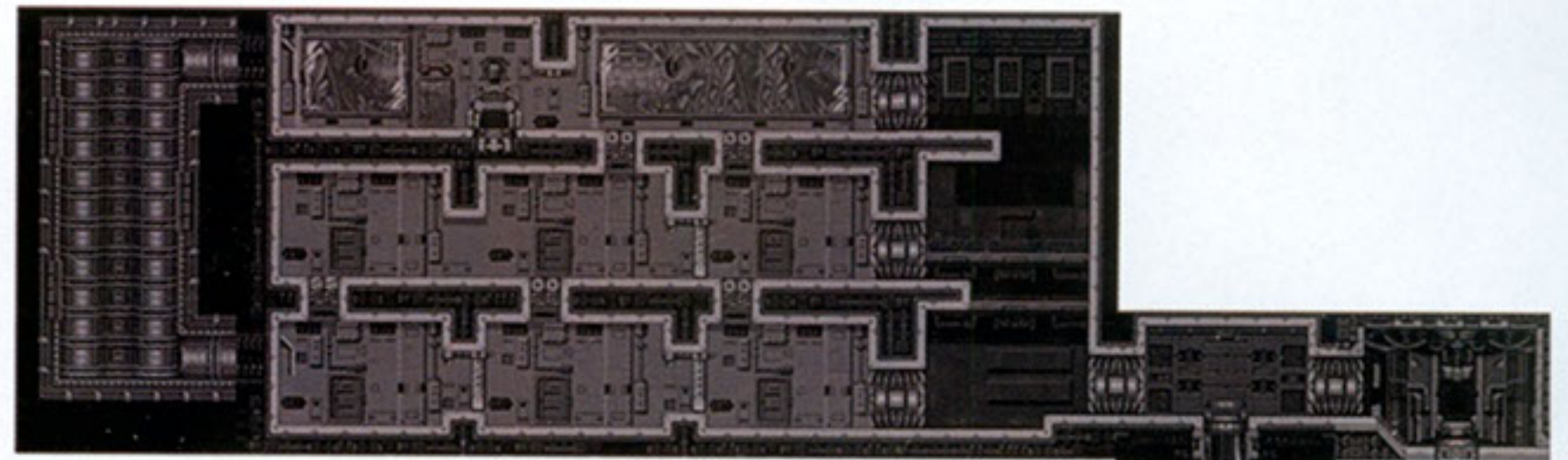

ROOMS AND HATCHES

- S** Save Room
- N** Navigation Room
- R** Recharge Room
- D** Data Room
- Level 1 Hatch
- Level 2 Hatch
- Level 3 Hatch
- Level 4 Hatch
- Special Hatch
- Shutter



To SECTOR I
PG. 22

BLOCKS

-  Bomb Block
-  Power Bomb Block
-  Missile Block
-  Boost Block
-  Screw Attack Block

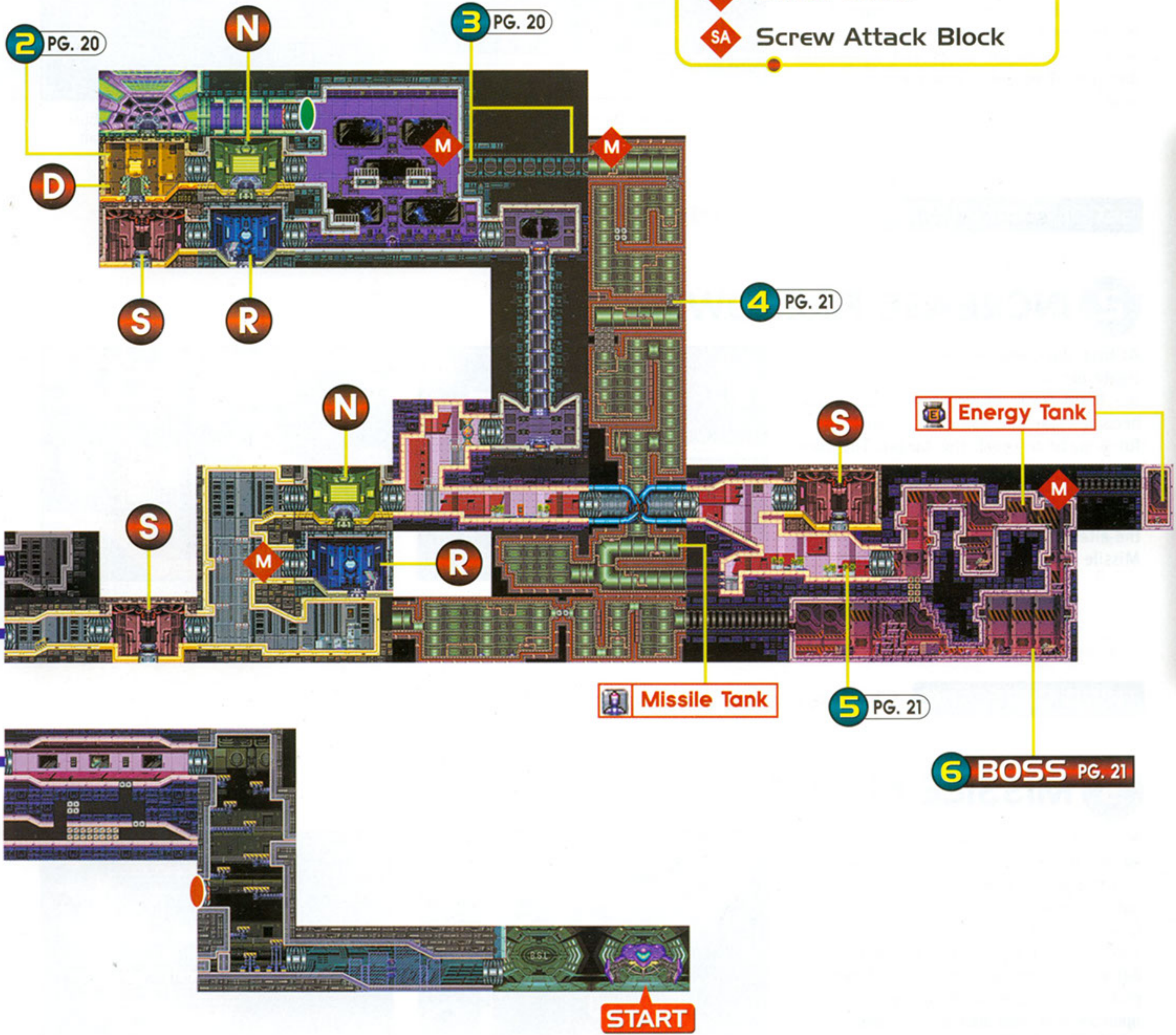

FIRST OBJECTIVE Go to the Quarantine Bay.

1 FIRST CONTACT

An explosion has been detected in the research station's Quarantine Bay, where samples from SR388 and pieces of Samus's suit are kept. You must make your way from the ship to the bay, stopping for more information at the Navigation Room along the way. You'll discover a single X parasite, in the form of a Hornoad. Defeat the creature with a few Beam blasts and absorb the parasite. Then check your objective on the map screen.

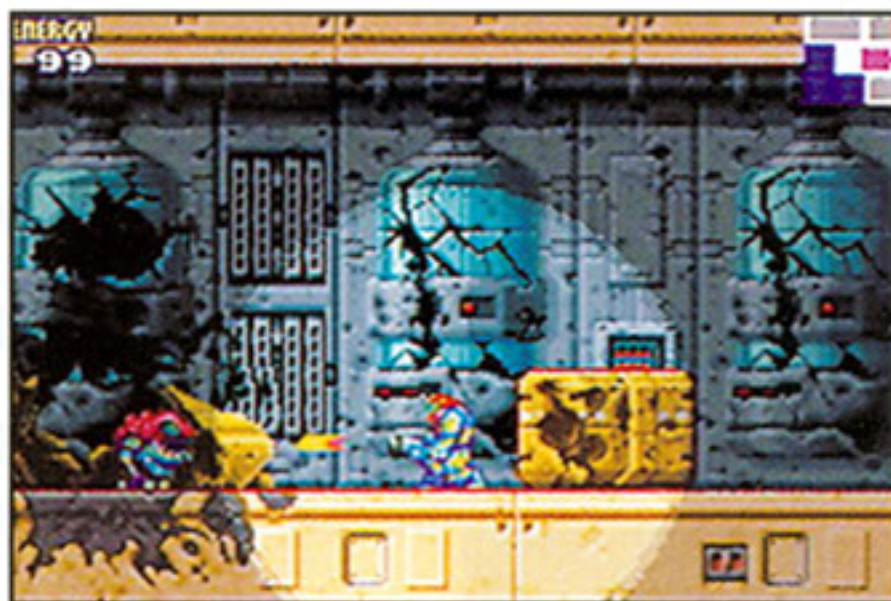

When you reach the Quarantine Bay, approach the creature, crouch and fire.



Once you've defeated the creature, check your objective, then return to the Navigation Room.

SECOND OBJECTIVE Download Missile data.

2 INCREASE FIREPOWER

At first, the computer will ask you to investigate bio-signs in the rightmost section of the Main Deck. As you get closer, it will become clear that you need a more powerful weapon to reach the target. The computer will give a new destination—a Data Room on the Operations Deck. Take the elevator to the upper deck then proceed to the alternate target, where you will collect Missile data.

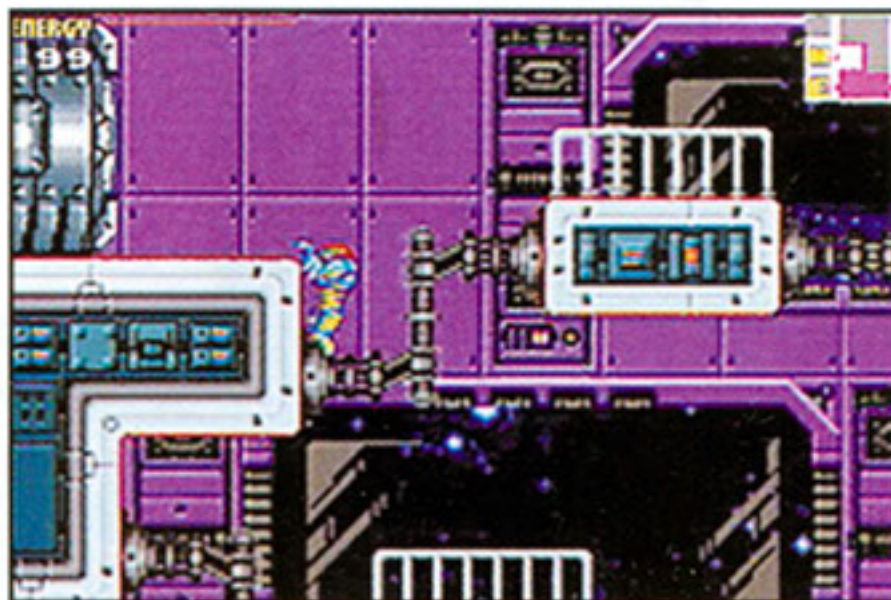

As you close in on the target, you'll take a long, high leap to a ledge. Hang on, then pull yourself up.

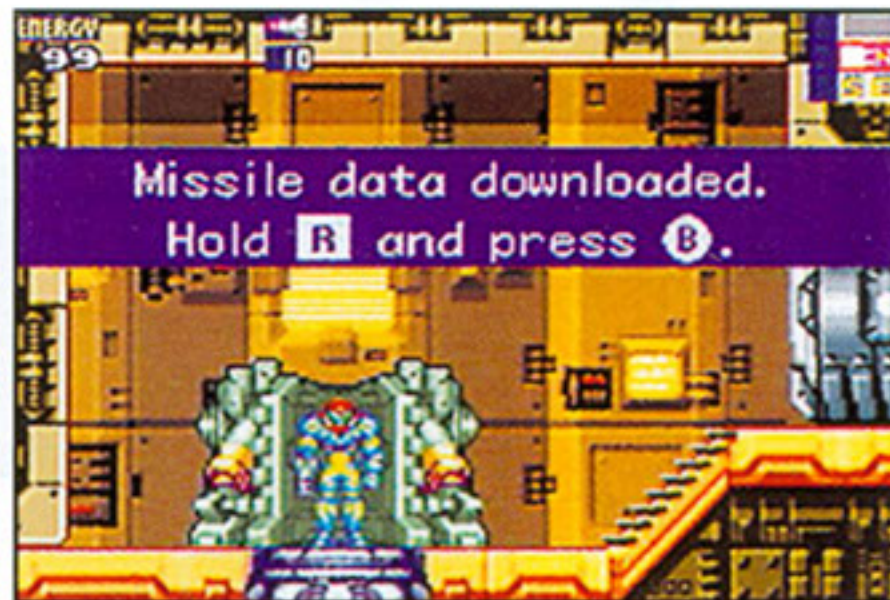

When you reach the Data Room, step into the booth and receive instructions for weapon operation.

THIRD OBJECTIVE Find an alternate route to the target.

3 MISSILE MOVEMENT

Plans change again. After you collect the Missile data, the research station computer will discover that electrical problems have put the elevators out of commission—it must be aliens in the wires. You'll have to find a new route to the original target. After you leave the Navigation Room, use platforms to jump to the other side of the open bay and blast open a red-glowing panel with a Missile. That's your alternate route.



Jump to the red-glowing panel, press R to switch to Missiles and blast your way into the next area.

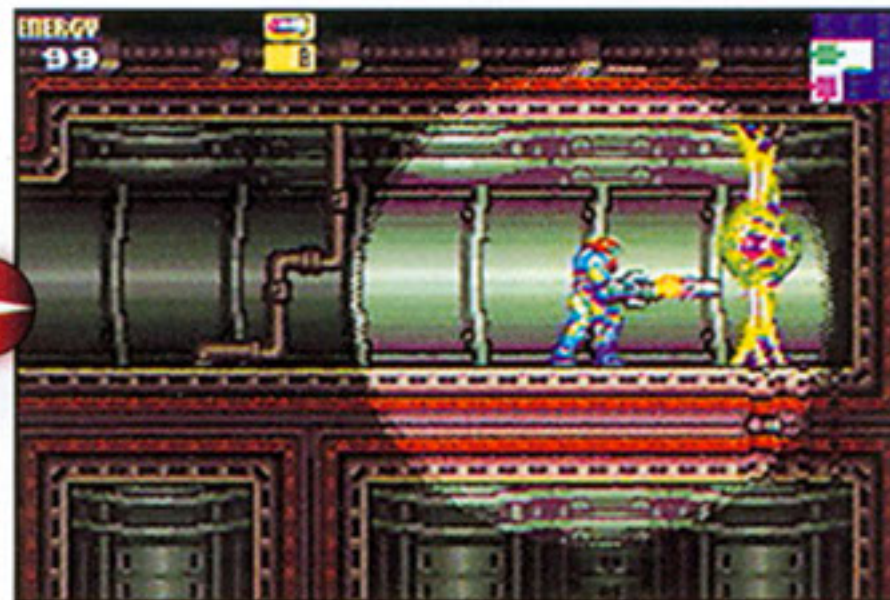

An alien creature blocks your path. Hit it with three Missiles then collect a green X parasite.

4 BREAK THE INFRASTRUCTURE

As you make your way down the alternate route to the area where bio-signs have been detected, you will fall through weak sections of the flooring, climb up and over obstacles and break sections of the wall with your Beam. On the way, you'll find a Missile Tank that will increase your Missile-holding capacity by five—and several weak enemies. Take them out with Beam blasts.

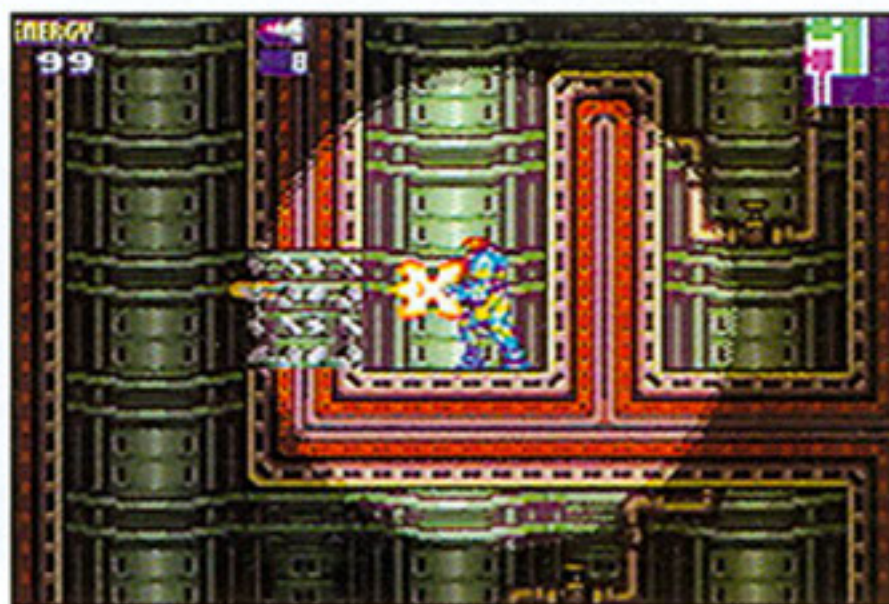

Open fire on the weak sections of the wall. The wall will crumble away and give you an open passage.

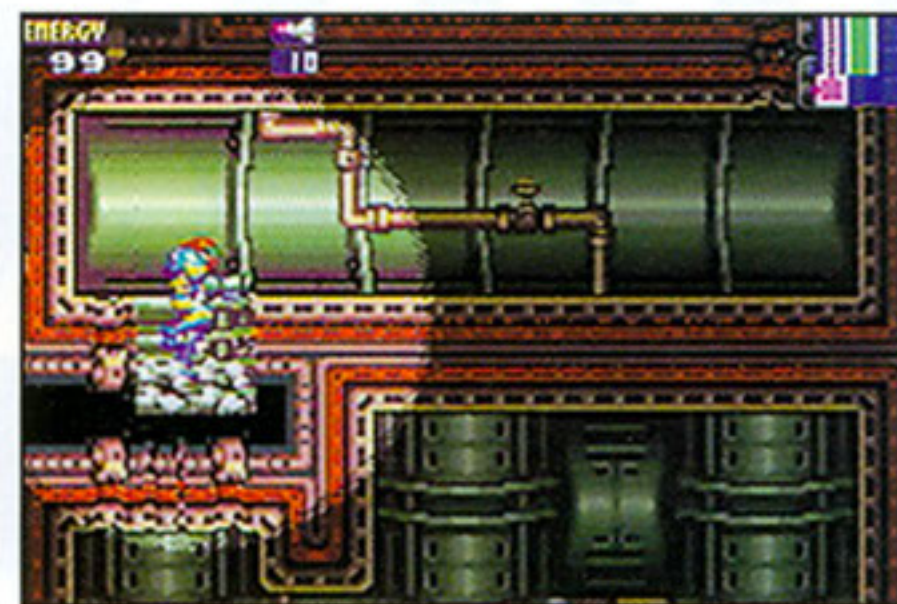

As you zigzag down the research station's service passages, you'll fall through several weak floors.

5 BATTLE AT THE HATCH

When you reach the Main Deck, you'll encounter two regenerating enemies and an eyeball-like creature that's guarding the hatch to the next area. If the eye opens and shows a pupil, hit it with a Missile. If it glows yellow and white, prepare to jump out of the way—it will send out a damaging wave of energy. If you're low on energy, defeat smaller creatures and collect the parasites, then fire on the eye again. Three shots will do the trick.



Fire on the small regenerating creatures and collect the X parasites for energy and Missiles.



Fire a Missile at the eyeball when it shows its pupil. Jump out of the way when it glows.

6 BOSS BATTLE

After you drop into the area where bio-signs have been detected, you'll see a Core-X transform into an alien creature

with a large shell on its back. Face off with the creature and hit it with Beam blasts or Missiles, then either jump over

it or jump up to grab the nearest ledge. The creature's shots will fly under your feet. If you're hanging from the ledge, wait for the creature to roll up into a ball and charge the wall. Before the impact, jump away from the ledge and over the beast. The creature will turn to face you. Hit it with another weapon barrage and repeat the process. When the beast turns back into the Core-X, hit it with Missiles. Your reward for victory will be the Morph Ball data.



One way to avoid damage from the shelled beast is to jump over it as it rolls toward you.



After you switch places with the creature, hit it with several Beams or Missiles.

SECTOR I

SRX

After you defeat the first boss and escape the area (using your Morph Ball ability), you'll discover that the parasites have spread to Sector 1.

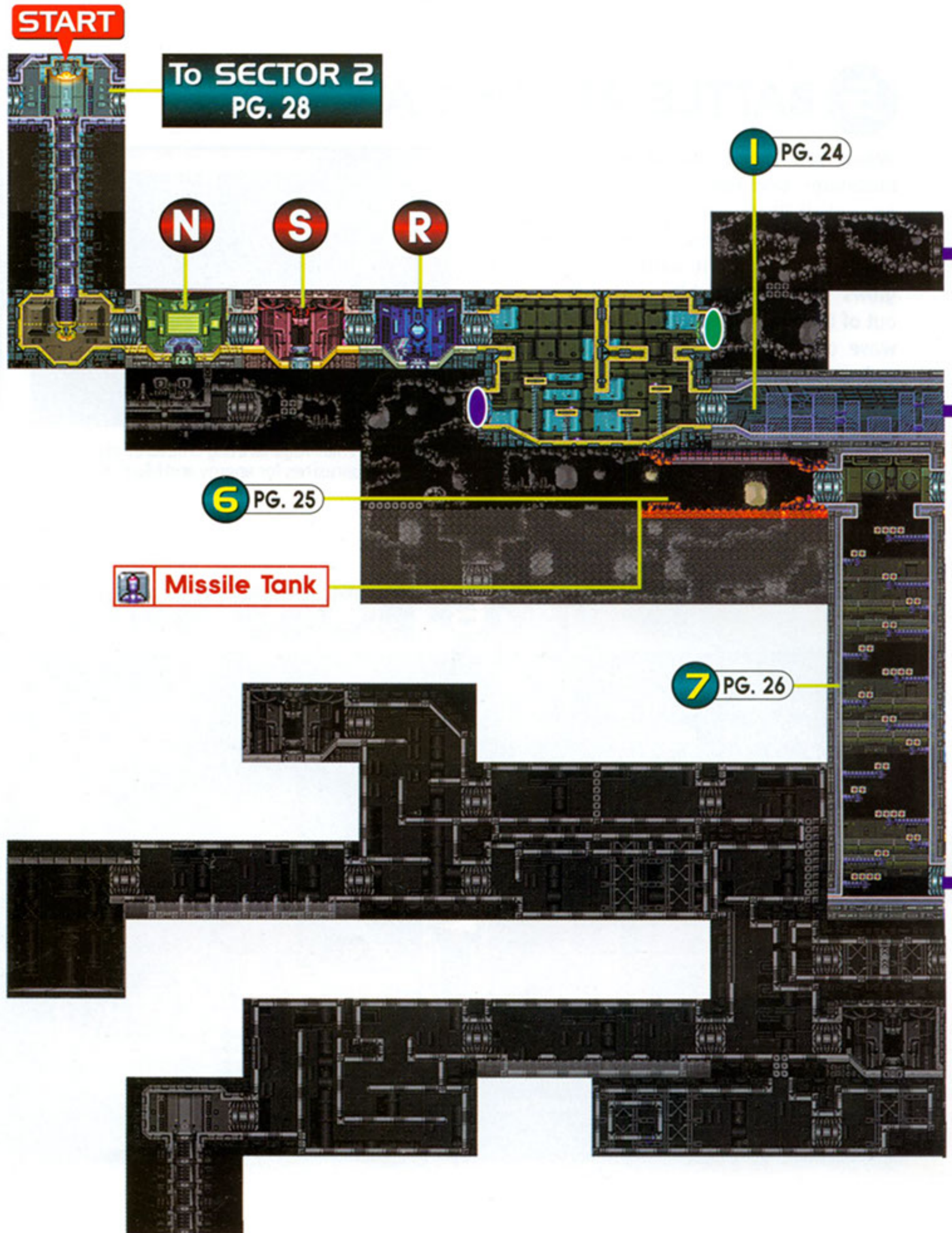

- BLOCKS**
- B** Bomb Block
 - PB** Power Bomb Block
 - M** Missile Block
 - SB** Boost Block
 - SA** Screw Attack Block

- ROOMS AND HATCHES**
- S** Save Room
 - N** Navigation Room
 - R** Recharge Room
 - D** Data Room
 - Level 1 Hatch
 - Level 2 Hatch
 - Level 3 Hatch
 - Level 4 Hatch
 - Special Hatch
 - Shutter

II BOSS PG. 27

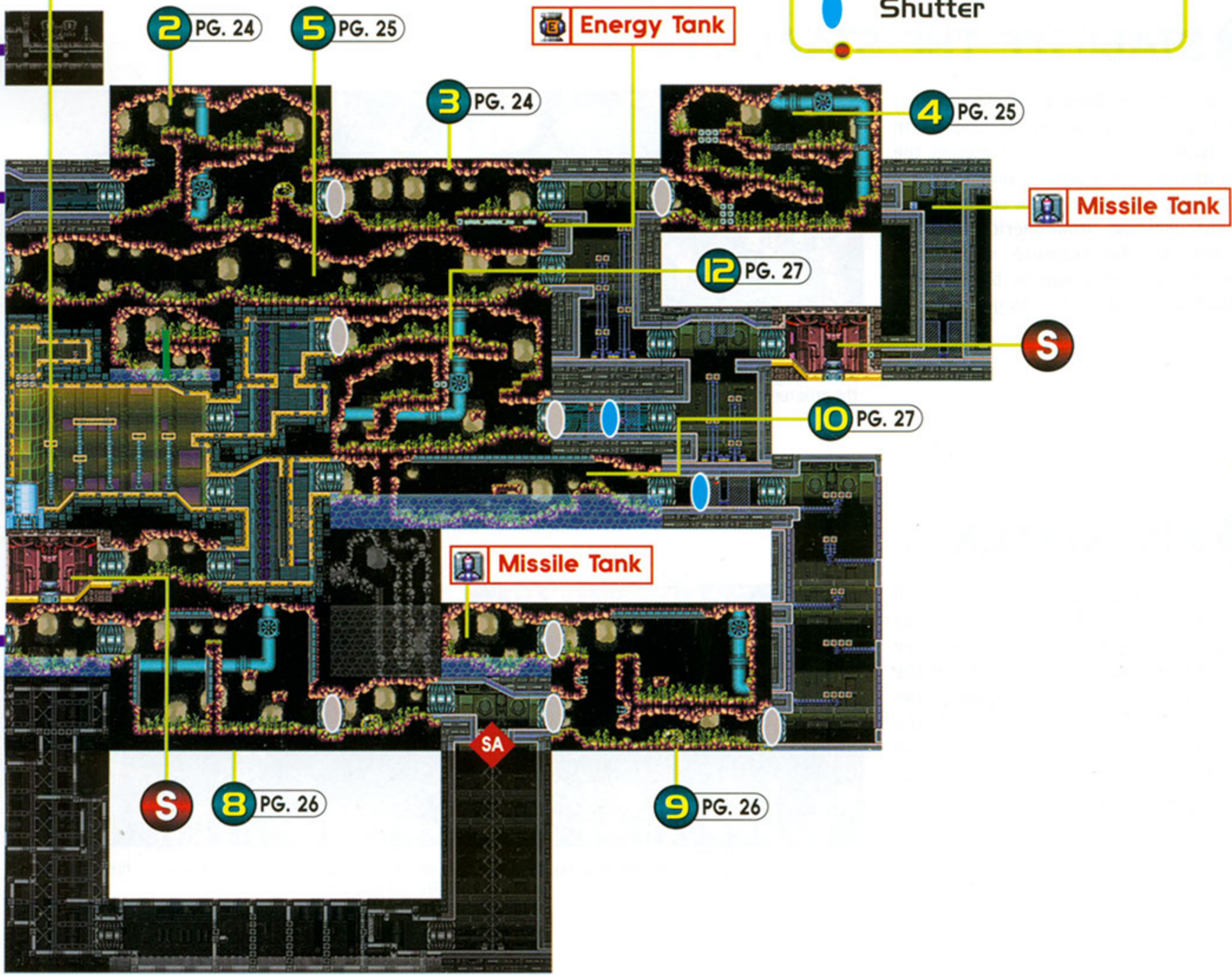

OBJECTIVE Release Level I locks. Download Bomb data.

1 BATTLE THE BLOBS

The parasites have taken over five atmospheric stabilizers in the Sector 1 ecosystem. On your way to investigate the trouble, you'll encounter a large, bloblike creature surrounded by smaller blobs. Avoid contact with the energy-sucking creatures and hit them with Beam blasts. When you reach the end of the hall, destroy the blocking organism with three Missiles.



Fire on the huge blob with your Beams before it floats up to you and depletes your energy.

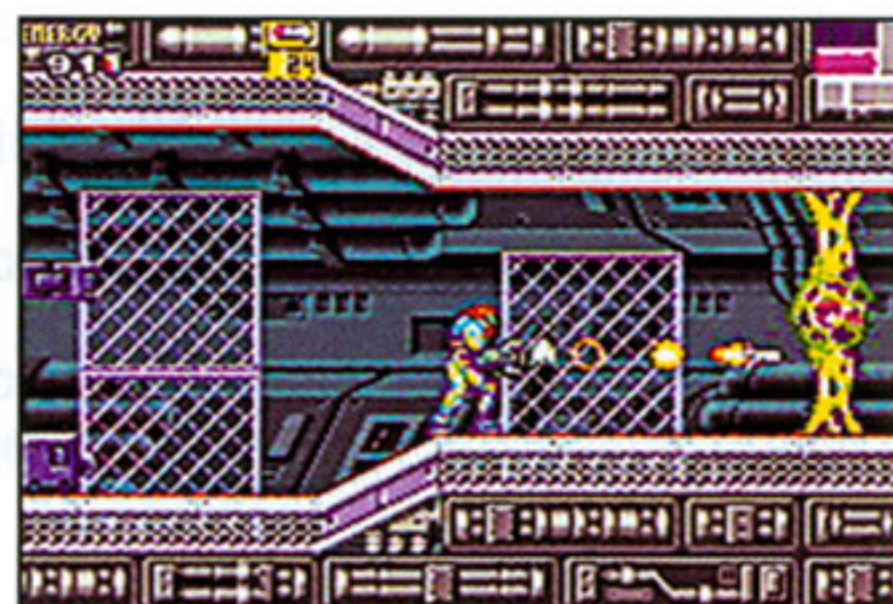

Hit the blocking organism at the end of the hall with Missiles, then collect a red parasite.

2 STABILIZE THE STABILIZER

When you enter the SR388 ecosystem, you'll notice that the atmosphere is thick with fumes. Work your way up and around the natural path and jump onto a rocky platform to get a good, clear shot at the creature that has taken over the atmospheric stabilizer. After you hit the creature with three Missiles, the stabilizer will go back online. One stabilizer repaired, four to go.



Aim through the opening of the stabilizer and hit the creature inside with three Missiles.

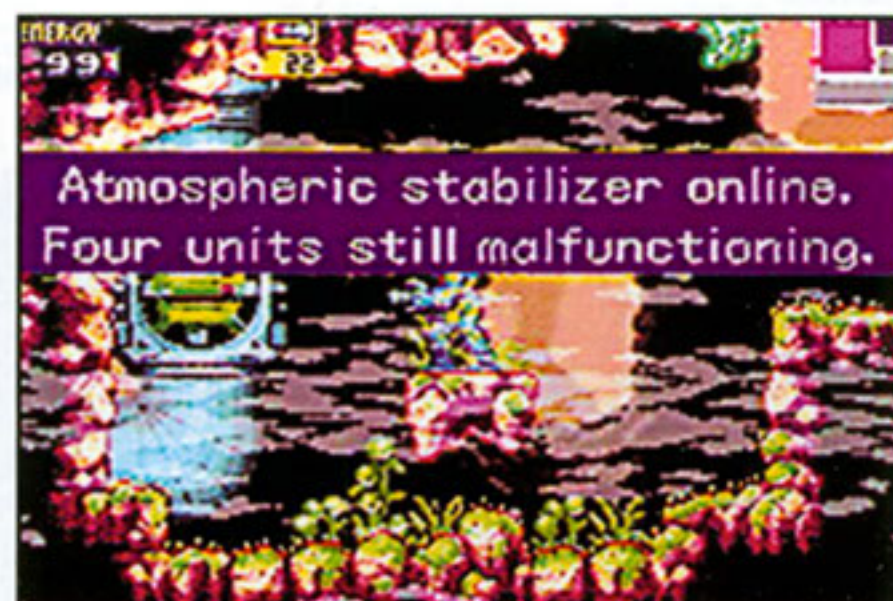

With the creature destroyed, the stabilizer will be back in working order.

3 AIR ATTACK

On your way to the second stabilizer, you'll encounter a passage that is populated by Hornoads and flying creatures that are protected by shells on two sides. Blast the Hornoads with Beams, then run under the flying creatures. The fliers will drop. If you want to defeat them, you can hit them with Beams from below as they fly back up. There is an Energy Tank in the room. Crouch to fire on a rock obstacle, then roll into the pipe and collect the tank.

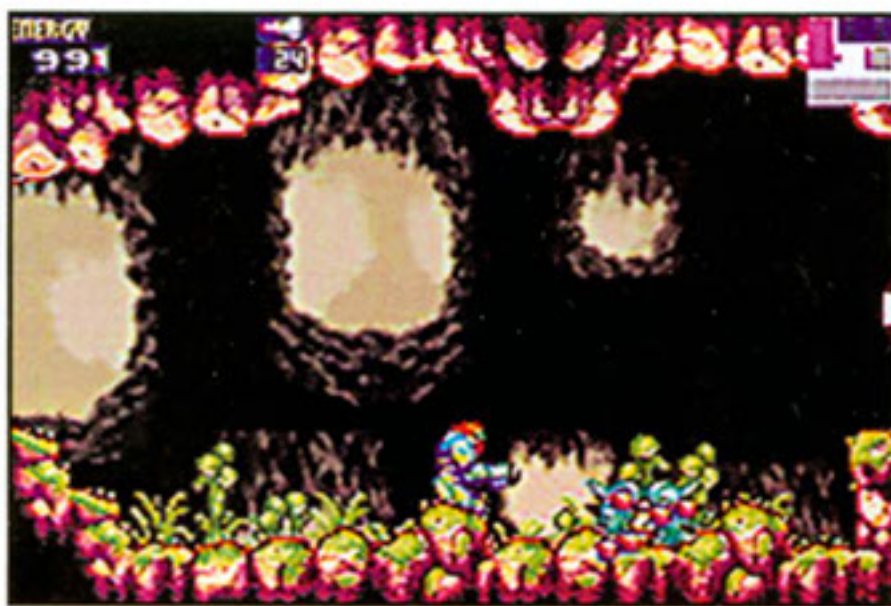

Run under a flying enemy to make it drop, then run out of the way.



As the creature returns to the roof, hit it with Beams from below.

4 BREAK BLOCKS

You'll find another stabilizer in an environment that appears to be blocked off by solid rocks. Fire on the rocks walls with your Beams to find sections that give way. When you get to the top of the area, run quickly across the terrain to avoid falling when some of the rocks crumble under your feet. Fire straight up at the stabilizer and hit it with three Missiles to clear away the enemy inside. When the creature is gone, the fan will return to working order.



Some of the rocks will give way if you hit them with Beams. Fire away to find a passage to the top.



Position yourself under the stabilizer and fire Missiles straight up—aim for the creature at its core.

5 JUMP, TURN, FIRE

On your way to the third stabilizer, you'll encounter three small but mean creatures that have protective faceplates. When the creatures charge, jump over them. Then when you land, turn and fire at their unprotected backsides. You'll have to be quick, or they'll turn and charge again. Collect the parasites that the creatures leave behind and move on to the next area.



When you face off with one of the small, armored creatures, it will charge. Jump over it.



After you land, turn and fire at the enemy from behind. You'll defeat it with a few quick blasts.

6 RED MENACE

One of the offshoot passages from the main vertical corridor is flooded with lava. If you drop into the lava, you'll lose energy at a quick and steady rate. Press A to jump, press Up on the Control Pad to have Samus grab the textured ceiling surface, then press Left to make her move over the lava to an island that holds a Missile Tank. You'll need the additional Missile-holding capacity for the challenges ahead.



Jump up and grab the textured surface on the ceiling, then work your way over to the left.



After you clear the lava, drop down onto the island and collect the Missile Tank.

7 ANGLE ON THE ENEMIES

It's appropriate that you should find Zebebian Space Pirates in a sector that mimics the atmosphere of SR388, the site of Samus's early Space Pirate battles. If you approach the pirates from an angle, you'll be able to avoid their lasers and lateral leaping attacks. Press L to fire diagonally and hit the pirates with Missiles. Each pirate that you defeat will produce two X parasites.



Use the L Button and Control Pad to aim at the enemies at an angle, either from above or below.

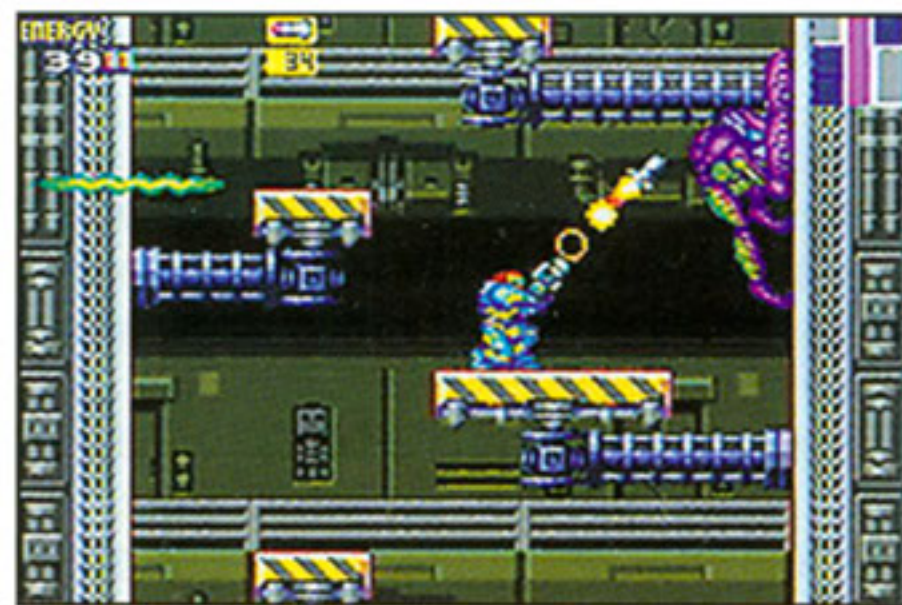

Hit the creatures with Missiles to clear them away, then collect the parasites that they leave behind.

8 SUSPENDED STABILIZER

The third atmospheric stabilizer that you will encounter floats near the top of a large open area. Make your way up and over a wall to the right side of the area, and climb a ladder up to the height of the stabilizer. Switch to Missiles and fire to the left, into the center of the stabilizer. Three perfectly aimed shots will destroy the creature and put the stabilizer back online.



If you drop to the bottom of the area, clear away the Hornoads with your Beams.



Climb up the ladder along the right wall and fire Missiles to the left, toward the stabilizer.

9 HANG AND FIRE

It's a slightly tricky climb up to the fourth stabilizer. You'll leap from one ledge to the next on your way up, then climb along the ceiling to the stabilizer. Hang from the ceiling with one hand while you fire at the stabilizer with Missiles from the launcher on the other hand. After you fix the stabilizer, go through the door in the room's upper-left corner to collect a Missile Tank.

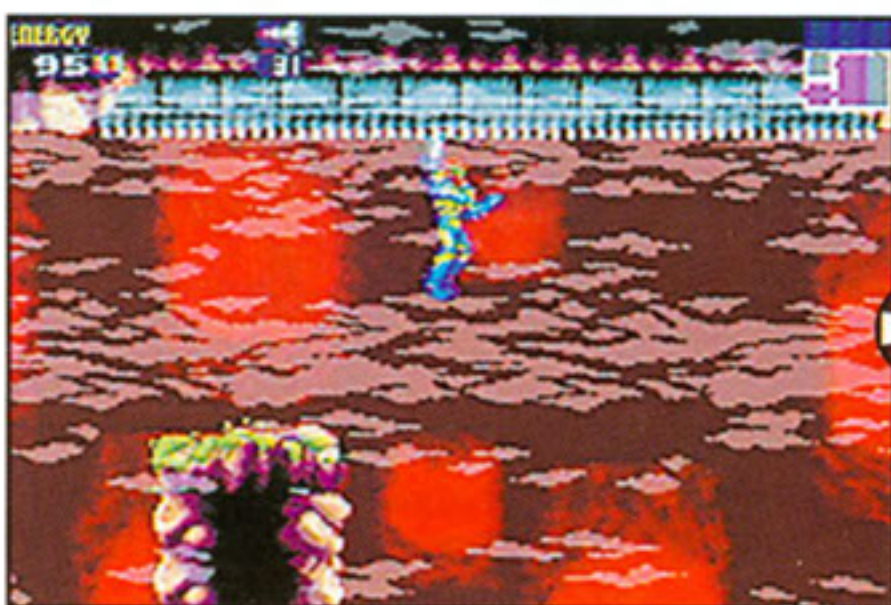

Grab onto the ceiling and move across the area, to the right.



Fire Missiles at the stabilizer as Samus hangs from the ceiling.

10 WRECK THE WALL

After you climb up another vertical passage filled with Space Pirates then work your way to the left, you'll reach a flooded room with a surface on the ceiling that you can climb across. When you reach the left side of the room, fire on the left wall to create a small opening. Drop down and to the left, grab the edge of the wall and pull up. Samus will turn into her Morph Ball form and roll through the hole.

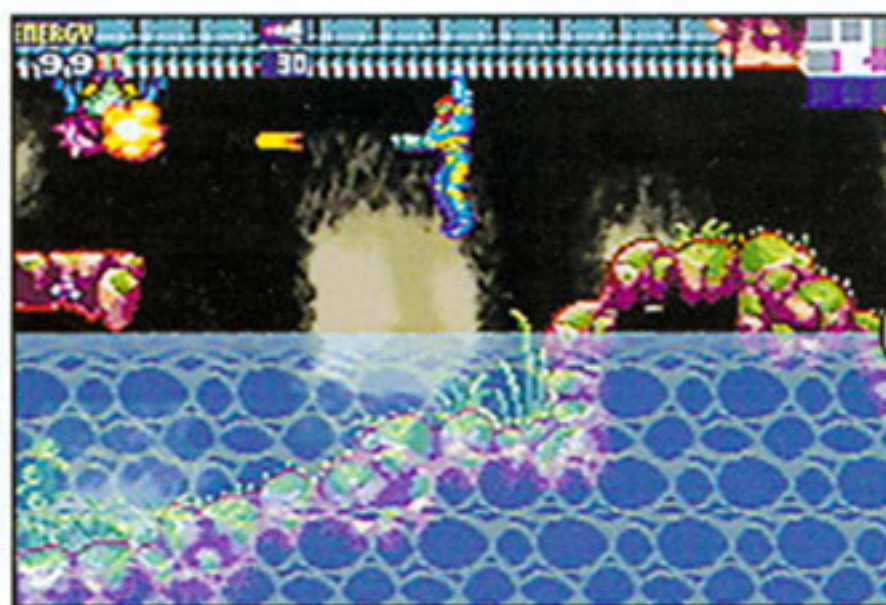

As you climb across the flooded room, clear away the enemies with constant Beam blasts.

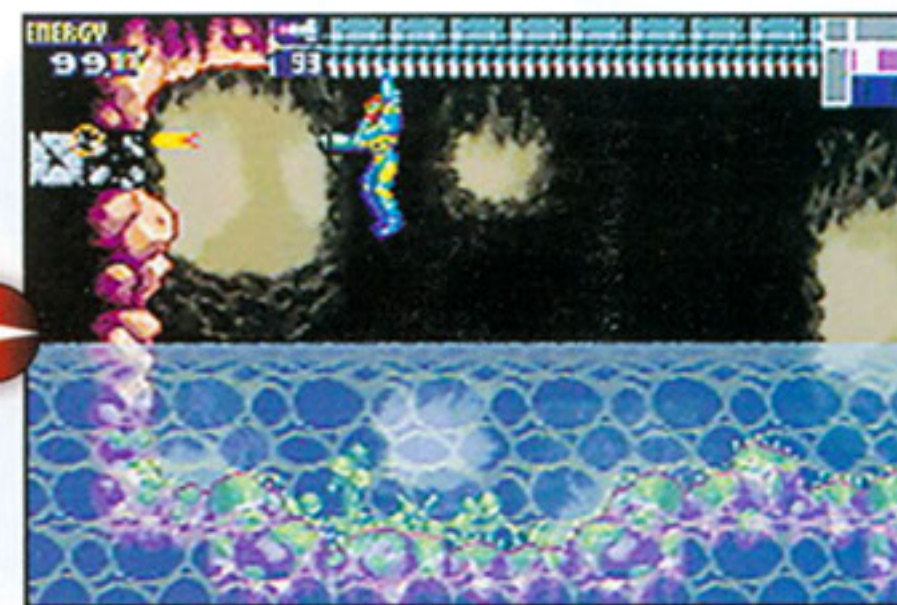

At the left end of the room, fire at the wall to create a small passage. Jump, morph and roll.

11 BOSS BATTLE

After you defeat an eyeball hatch guardian and collect the powerful red X parasite that it releases, enter the boss battle arena, run to the left side of the room and fire Beams at the ball in the hands of the

statue. A Core-X will come to life and attack you. The round, armored creature has a small eye. When the eye is open, it is vulnerable to Missiles. If you can't tell whether its vulnerable or not, fire away

anyway. With enough shots, you'll outlast the beast. Your prize for victory is the Charge Beam.

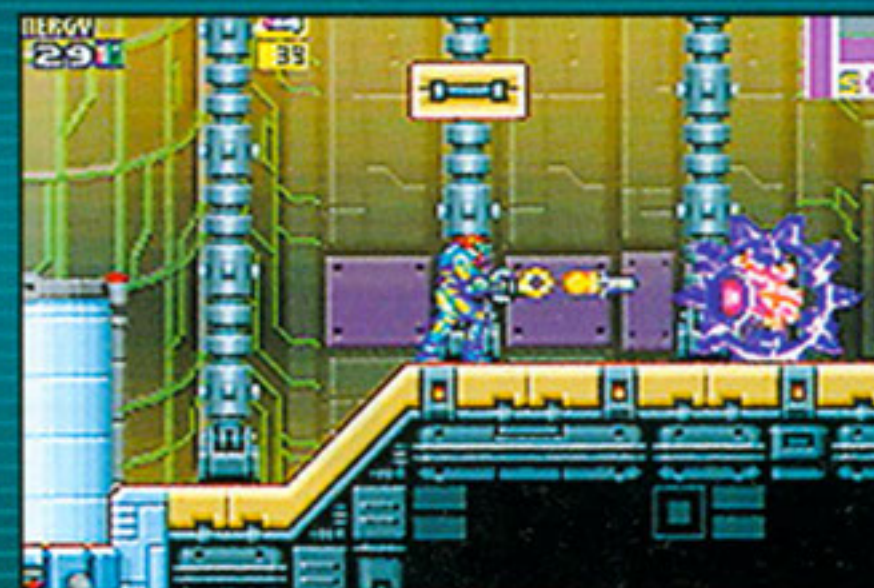

Avoid the charging attacks of the Core-X creature and the lasers that emanate from its eye. Hit it with Missiles then jump to avoid its return fire.

12 STABLE, AT LAST

After you leave the boss arena through the upper-right door, fire up at the ceiling to find passage to the next SR388 environment. The final stabilizer is facing a wall. Work your way around to the other side of the wall and cut through it with your Beam. Then unload three Missiles, or charged-up Beam blasts, into the stabilizer. When you defeat the creature inside, the air will clear up and the atmosphere will return to its normal state.

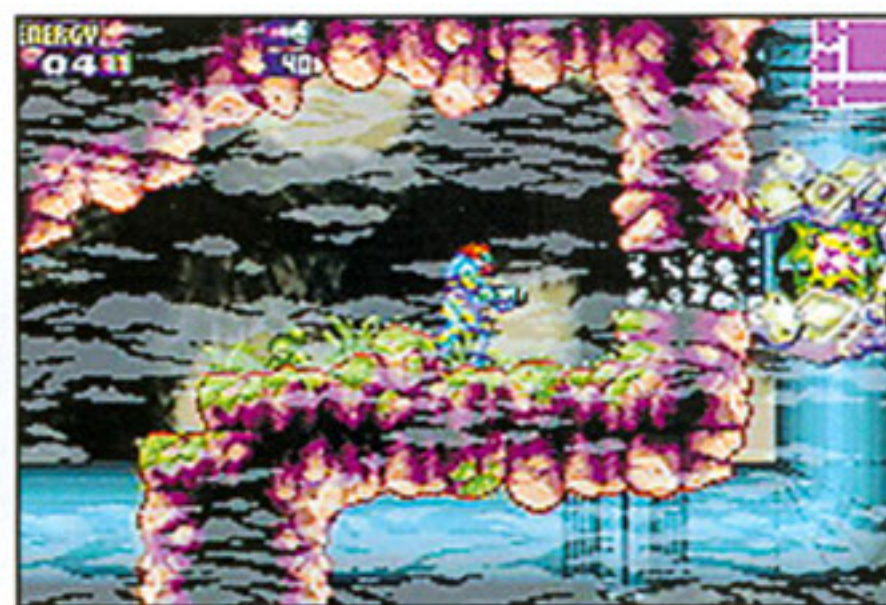

Blast through the wall to expose the opening of the last atmospheric stabilizer.



Defeat the creature inside the mechanism with charged Beams or Missiles.

SECTOR 2

TRO

After your battle to restore the stabilizers in Sector 1, you'll discover that an unseen saboteur is letting parasites loose on the station. The saboteur is an X parasite copy of Samus. I have named it the SA-X.

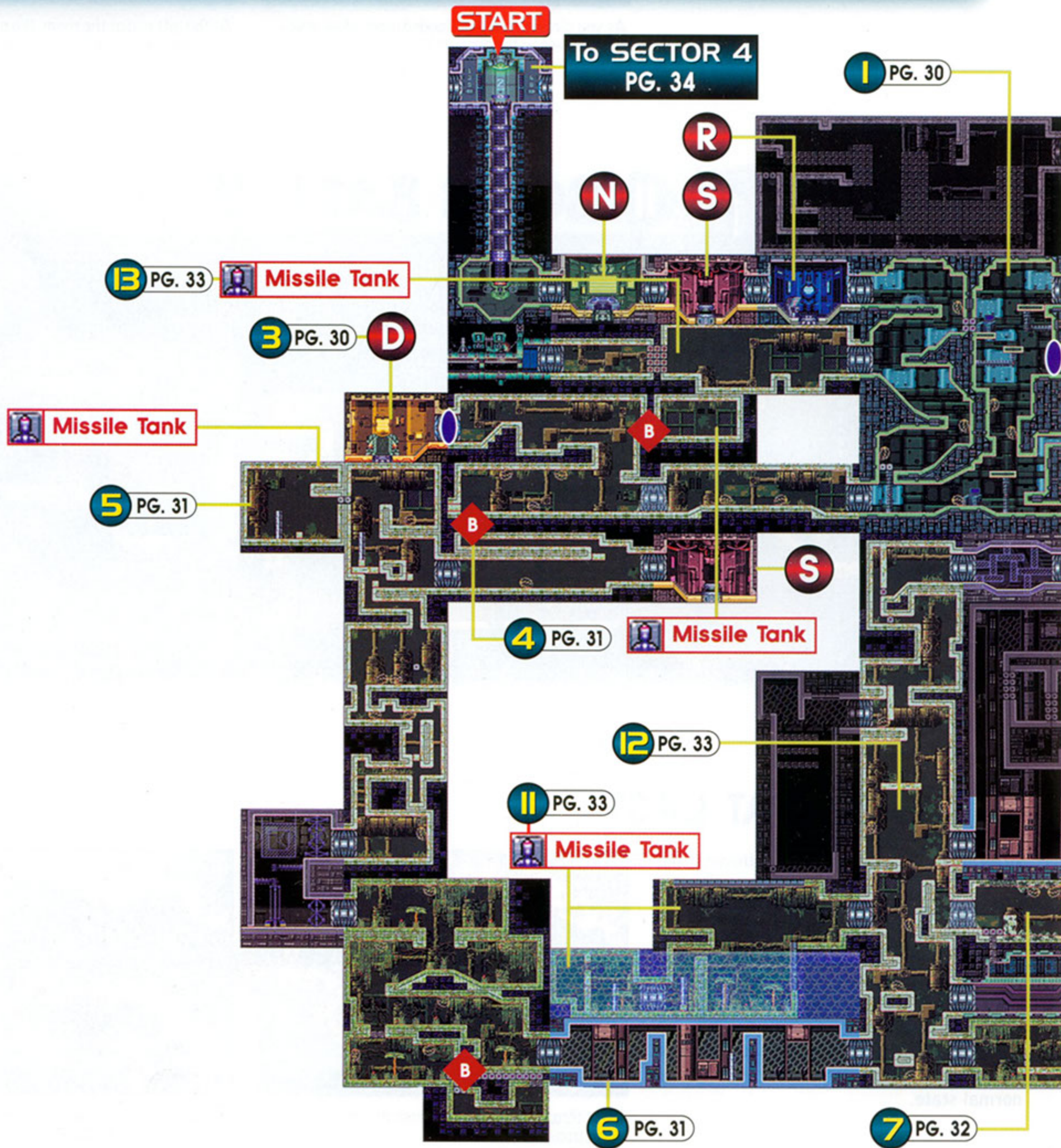

- BLOCKS**
- B** Bomb Block
 - PB** Power Bomb Block
 - M** Missile Block
 - SB** Boost Block
 - SA** Screw Attack Block

- ROOMS AND HATCHES**
- S** Save Room
 - N** Navigation Room
 - R** Recharge Room
 - D** Data Room
 - Level 1 Hatch
 - Level 2 Hatch
 - Level 3 Hatch
 - Level 4 Hatch
 - Special Hatch
 - Shutter

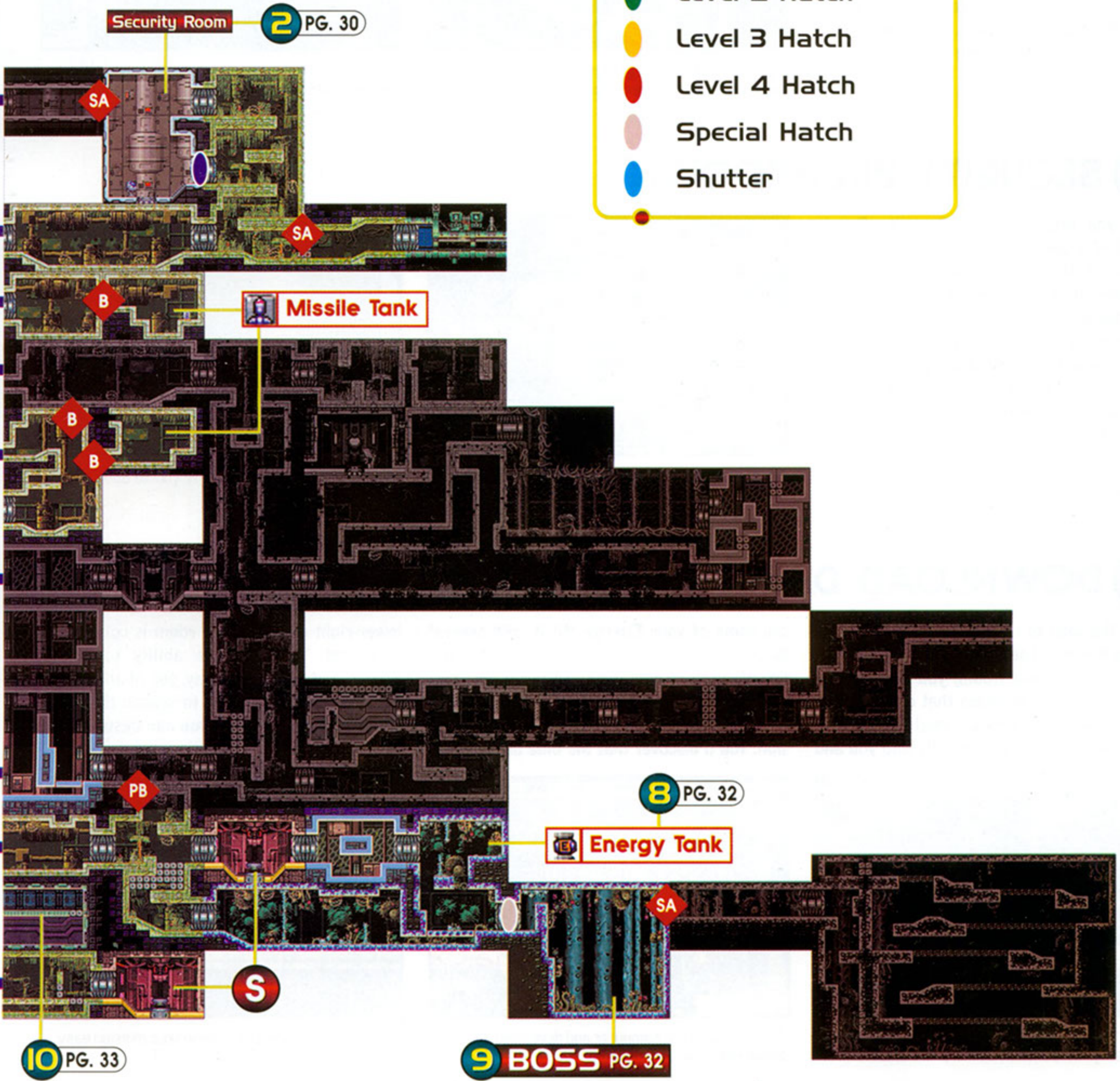

FIRST OBJECTIVE Release Level 1 locks. Download Bomb data.

1 SCOOT AND SHOOT

Before you can proceed to the Data Room and download Bomb Data, you must release the Level 1 locks. The Security Room is in the upper-right section of Sector 2. To get there, you will drop down the left side of a vertical corridor, cross to the right side, climb up then make your way through a jungle environment. On the way, you'll encounter several red creatures that crawl along the walls and floors. Blast them with your Beam and collect the parasites.



Hit each wall-crawling creature with several Beam blasts and avoid close contact.

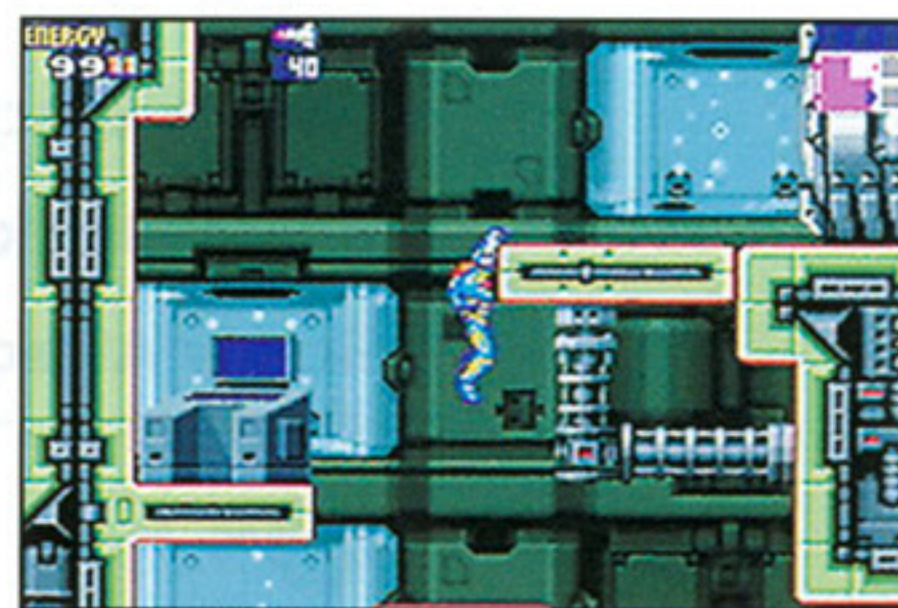

You'll take a long leap in the upper-right section of the vertical corridor. Grab the ledge and pull up.

2 SECURITY BREAKDOWN

When you drop into the Security Room, you'll find a computer uplink device. Log in and unlock the Level 1 hatches. The move will open all blue hatches. It will also allow the X parasites to spread to new sections. As you make your way to the target area where you will download Bomb data, you'll reach a blue hatch that leads to a room full of small creatures. Clear the room and collect the flying parasites to replenish your energy.



Drop into the Data Room and connect with the computer to unlock Level 1 hatches.

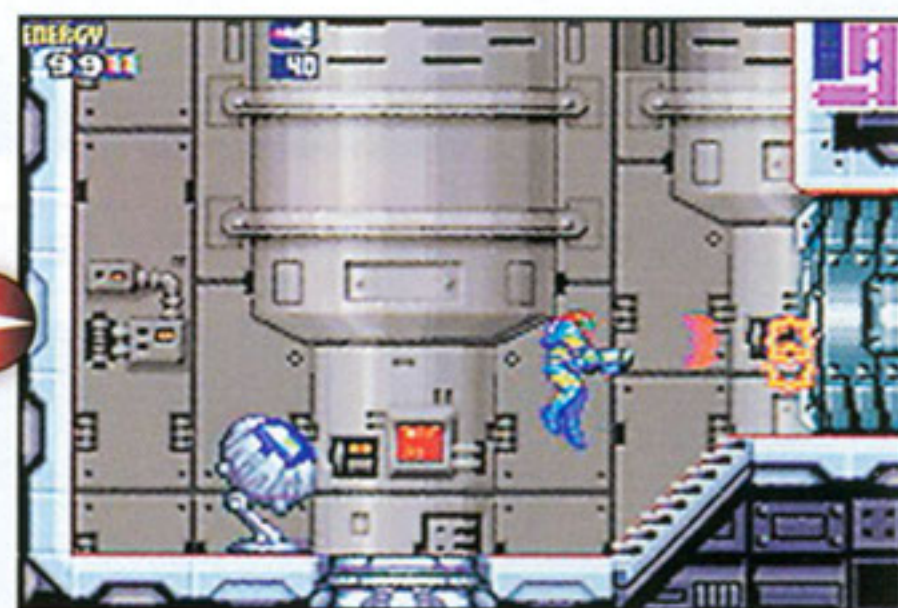

The security unlock will allow you to open all blue hatches with your firepower.

3 DOWNLOAD DATA

Follow the map to the target area and move into the lower-left section of Sector 1. Before you reach the Data Room, you'll encounter several of the red enemies that crawl on the walls and one fast-moving, buglike beast. If you're not quick, the bug will fly into you and

sap some of your Energy. Hit it with several Beam blasts or a single Missile. After you download the Bomb data and leave the Data Room, you'll hear an explosion. Something, or someone, is trying to sabotage your mission. You'll discover that the blue hatch in the

lower-right corner of the room is completely destroyed. You have the ability to create Bombs and blast your way out of the room, though. The next step is to search the room and look for blocks that you can destroy with Bombs.



On your way to the Data Room, you'll encounter a new enemy. Hit it with Beams or a Missile.



Connect with the computer and download the Bomb data. Roll and explode!

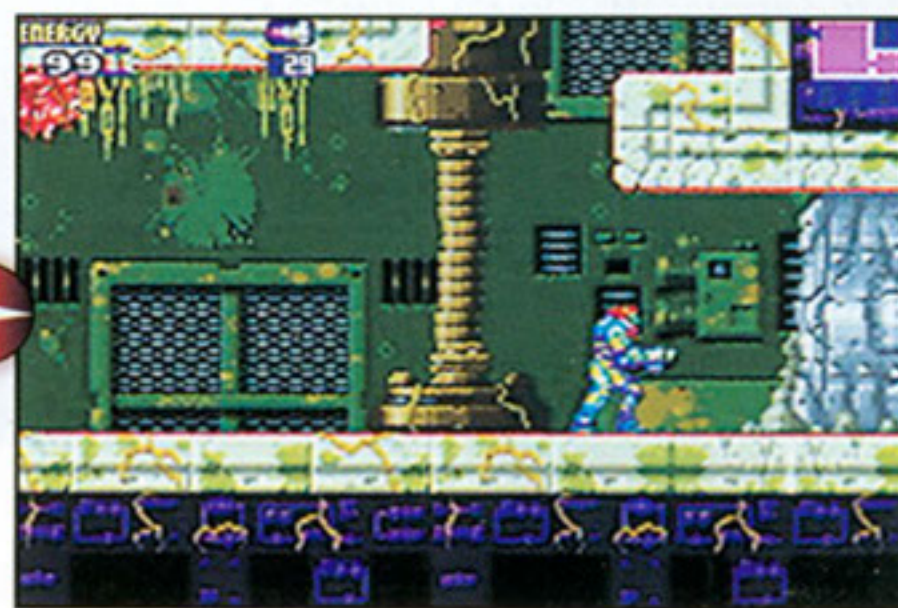

The X parasites are not making your mission easy. The main hatch has been destroyed.

SECOND OBJECTIVE Advance to the Sector 2 boss.**4 HAVE A BLAST**

You'll discover two places where you can break blocks with Bombs in the room that has the blown hatch. Jump up to a short ledge in the upper-right section to bomb your way to a passage that holds a Missile Tank. After you collect the tank, roll to the lower-left corner of the large room and blast through to a passage that is not on the computer's map. As you explore the new passage, enter the hatch on the right side and save your game data.

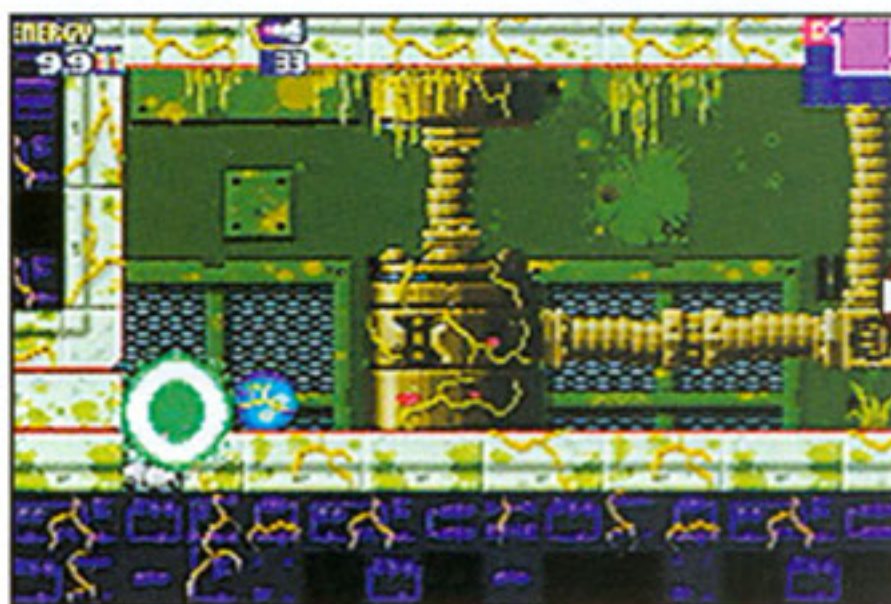

Place a Bomb in the lower-left corner of the large room to create a hole. Roll and drop.

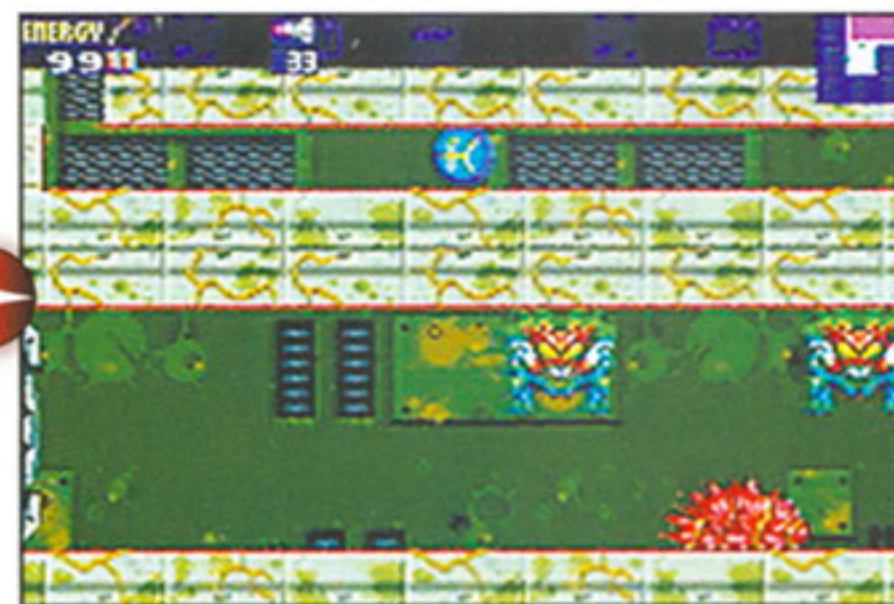

A narrow passage leads to a new area that is not on the computer's map.

5 MISSILE MISSION

You can make metallic posts lift up from the ground or extend from the wall in some areas by detonating Bombs at their locations. When you enter the room that has a covered passage along the floor, jump up to the left side of the room, over the passage, and detonate a bomb on the block in the area. A post will rise. Jump onto the post, then leap to the ledge on the right side, crouch and fire a Beam to the left. You'll blast a hole through the left wall. Jump over to the hole and climb through to a room where you will find a Missile Tank.

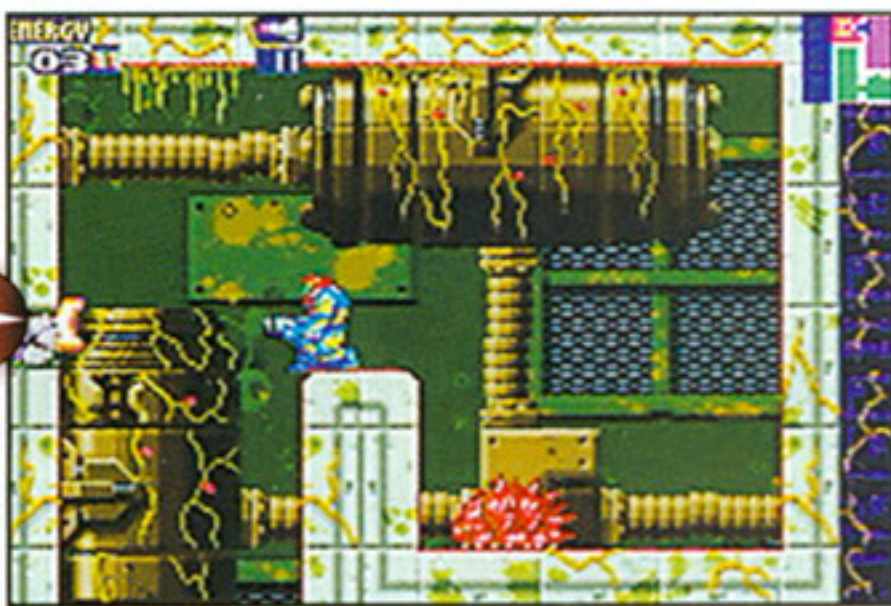
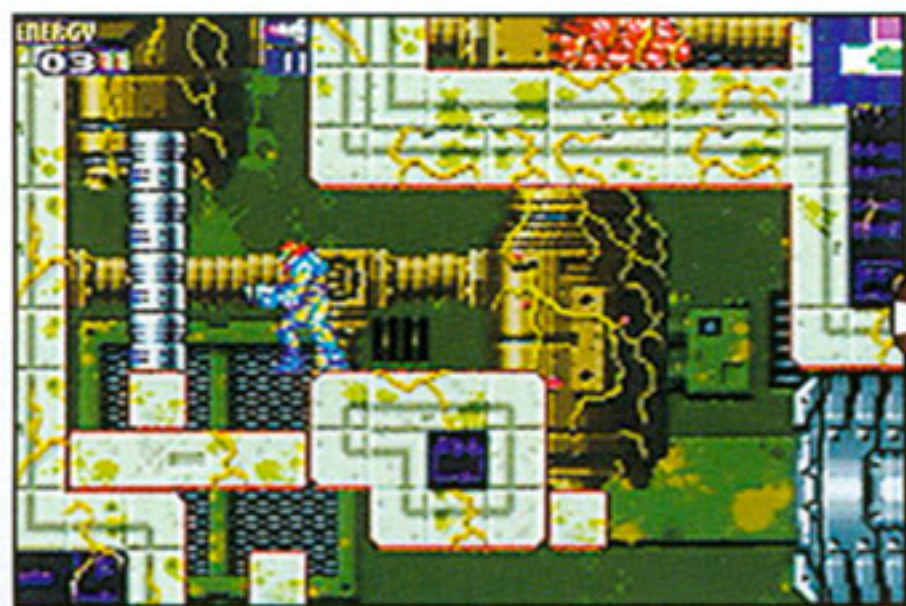

Use a Bomb to make a post rise from a block. Then climb up to the ledge, crouch and fire to the left. You'll discover a tunnel to another room. When you reach the next room, plant Bombs on the floor. One of the detonations will cause another pole to rise from the floor. Use it as a boost to a Missile Tank.

6 POLE POSITION

Bomb blasts will allow you to explore a large section of the Sector 2 underground. You'll break through several Bomb Blocks and, at least once, use the propelling power of a Bomb blast to lift you up and over an obstacle. When you reach a tall blue barrier, place Bombs on the ground near the barrier. A detonation in the right place will cause a pole to rise from the ground, giving you a boost over the barrier.

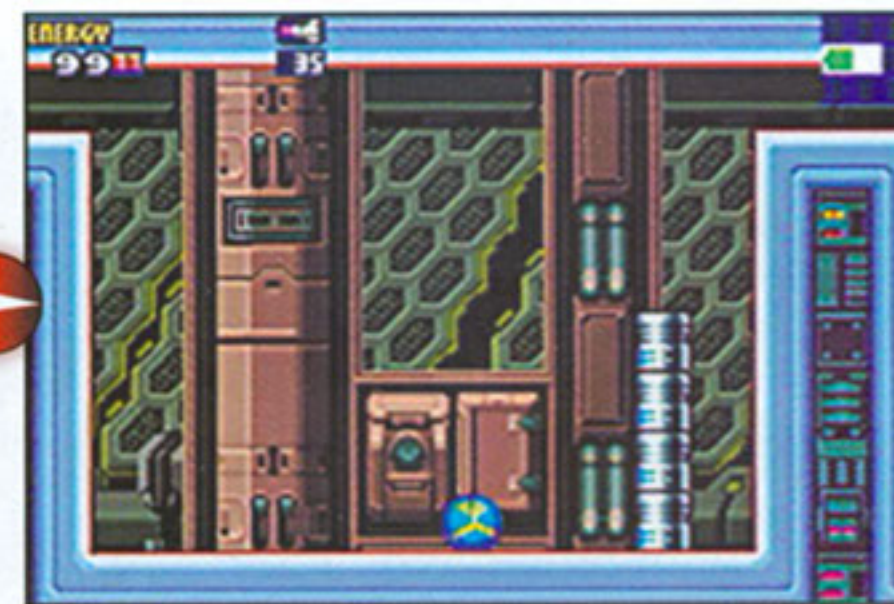
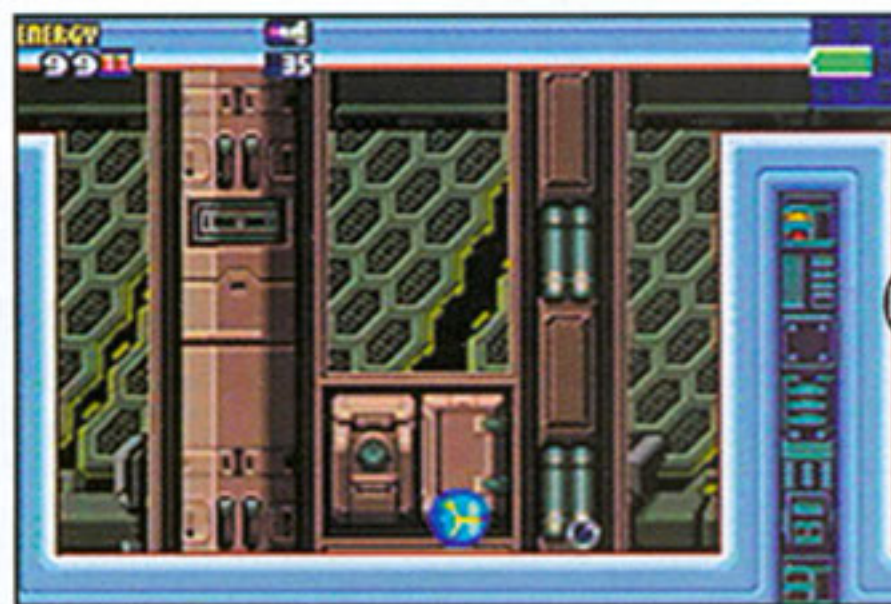

7 PARASITE BACKFIRE

On your long approach to the Sector 2 boss, you'll encounter a hopping, buglike creature that can be deceptively difficult to defeat. It moves quickly, and when you shoot at it, it shoots back. Fire at the beast, then jump to avoid its shots. The red creatures that crawl on the ceiling are relatively easy to pick off. Hit them with Beam shots and collect the parasites they leave behind to replenish your energy and Missile supplies.

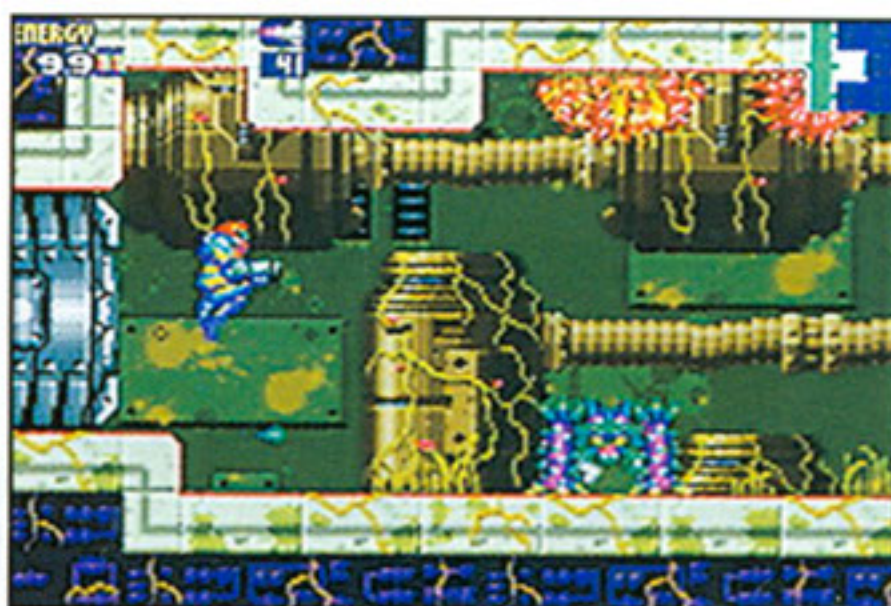

After you shoot at the hopping bug, jump to avoid its return fire.

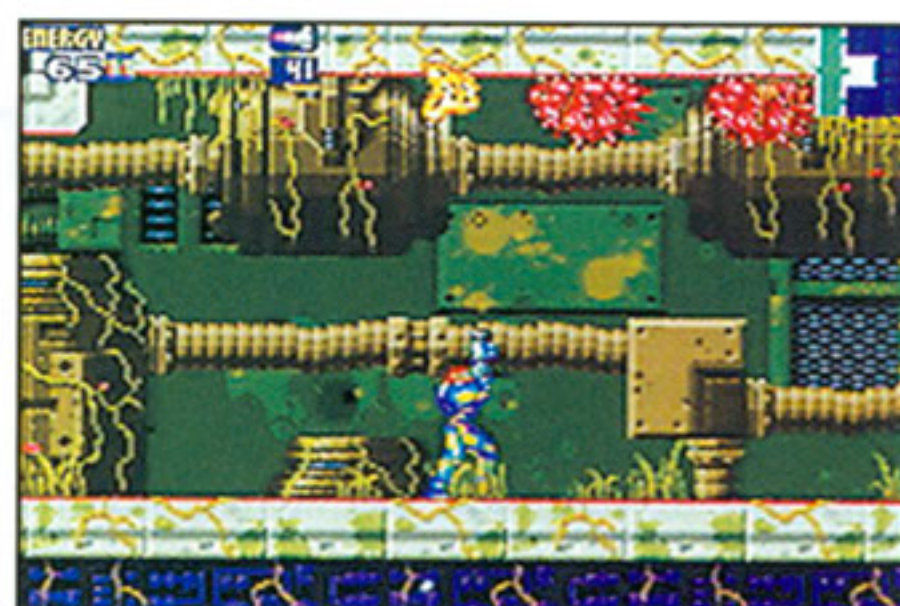

Blast away at the creatures on the ceiling and fill your energy reserves by absorbing yellow parasites.

8 ENERGY EXTRA

After you discover the Energy Tank that is two rooms to the right of the Save Room, you may feel compelled to turn around and look for another path to Sector 2, since most tanks are located in dead-end passages. If you stay and explore, you'll discover that you can blast through two sections of the floor in the Energy Tank room. Use the holes to drop into a room that an eyeball hatch guards. Wait for the eye to show its pupil, then hit it with Missiles.



You can blast holes into the floor of the room with the Energy Tank. Collect the tank before you drop.



Hit the open eye with Missiles, but be ready to jump if it flashes yellow and white.

9 BOSS BATTLE

The tall, segmented Sector 2 boss creature hops then stomps the ground. If it lands on you, it will consume you for a moment and sap your energy. You must Bomb your way out of

the beast to escape. Run under the boss when it's in the air. Then when it opens its mouth and begins to float to the ground, position yourself directly under it and launch Missiles,

through the mouth, aiming for the eye. After you hit the creature several times, it will revert to Core-X form. Hit it with more Missiles to collect the Hi-Jump and Jumpball.



The segmented creature's skin protects it from your shots. You must find a weak spot.



When the creature opens its mouth and floats slowly to the ground, fire Missiles straight up into the mouth of the beast.



THIRD OBJECTIVE Proceed to the Navigation Room.

10 SA-X ENCOUNTER

Following your battle against the Sector 2 boss, you'll backtrack and stop at a blown hatch. Plant bombs on the ground near the hatch to find a path out of the tunnel. When you reach a room that has two horizontal corridors, wait at the upper corridor and watch the Samus-mimicking SA-X make an appearance in the lower corridor. If you confront the creature, it will pulverize you. Wait for it to leave, then move on.

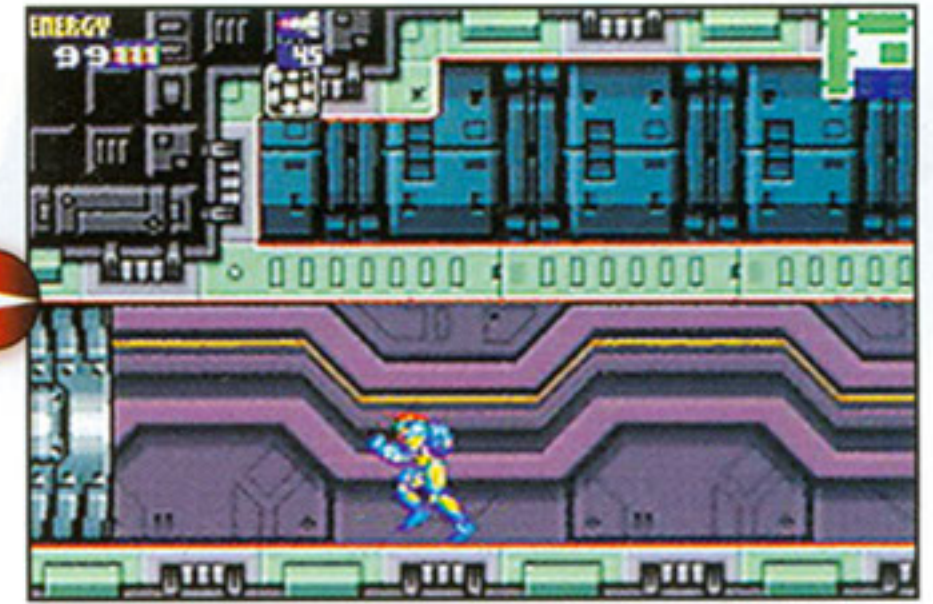

11 UNDERWATER ADVENTURE

The Hi-Jump and Jumpball abilities allow you to explore areas that were previously out of reach. You'll find a horizontal ladder on the ceiling of the flooded chamber. Use your advanced jumping ability to reach the ladder

and climb over the water to a Missile Tank. After you collect the tank, drop into the water and plant Bombs on the floor. A pipe will rise from the ground. Jump onto the pipe, then jump left to the next section. Once there, plant

Bombs on the ground to make another pipe rise. Jump onto the pipe, form a Morph Ball and jump in ball form to the left. Plant a Bomb when you hit the wall. You'll open a passage to another Missile Tank.

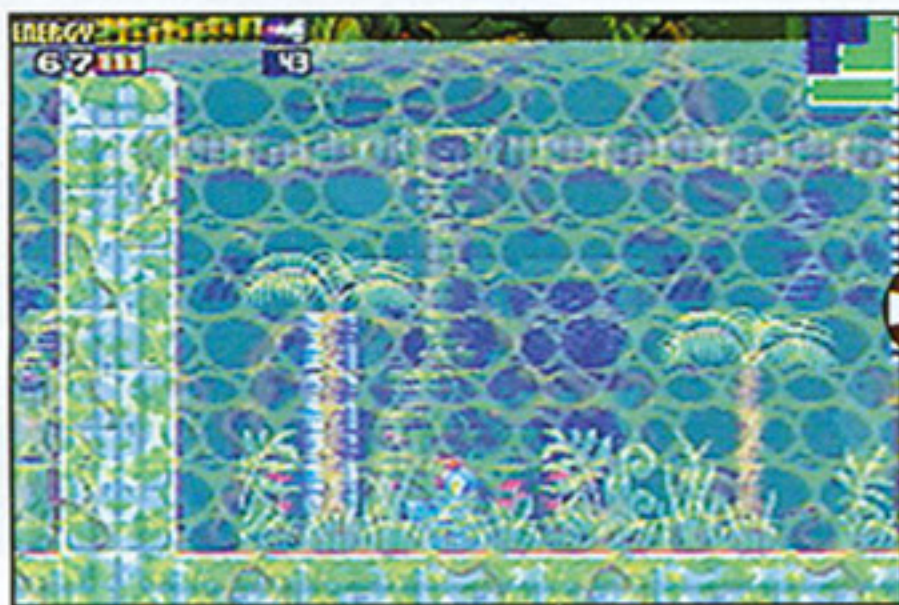

Plant Bombs on the floor to make a pole rise from the bottom of the tank.

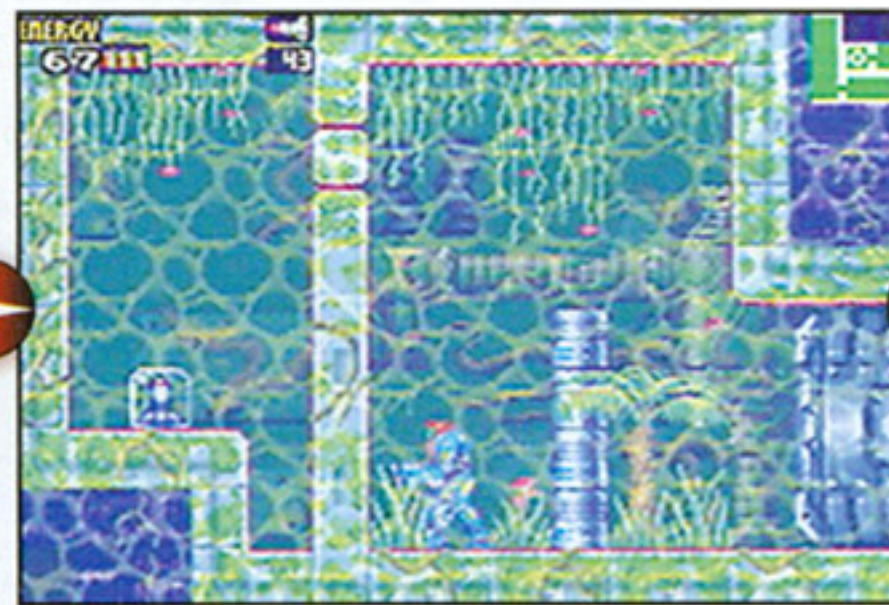

After you make your way to the left, use Bombs to make another pole rise.

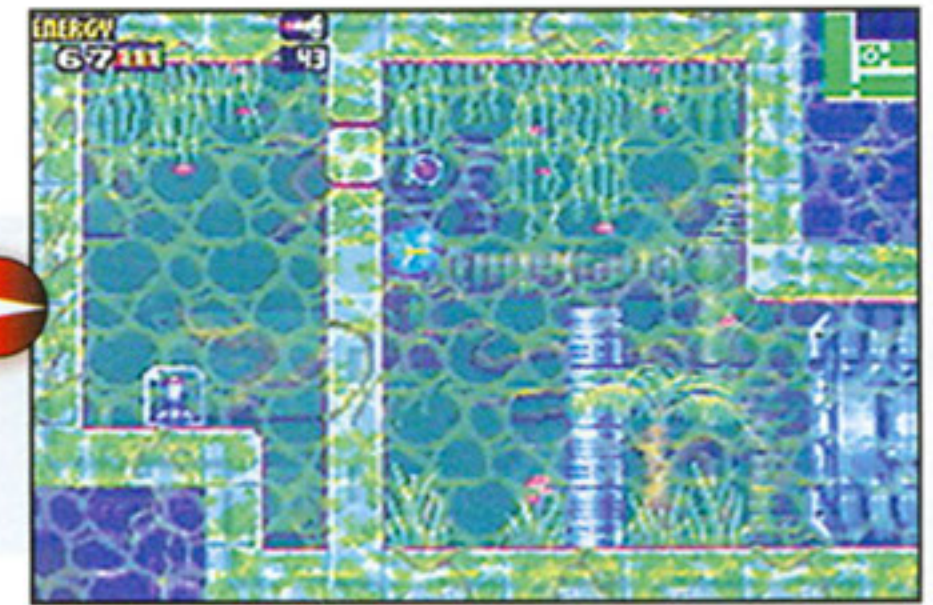

Hop from the pole in Morph Ball form, and plant a Bomb. You'll clear the way to the prize.

12 HOP TO THE HATCH

After your close encounter with the SA-X, the being will exit to the long vertical passage and freeze all of the wall-crawling creatures. You can use the pupating creatures as platforms as you jump and climb up to the top of the passage. When you get to the top, roll into a tight passage, jump in ball form and set a Bomb at the top of your jump. The explosion will break a block and give you passage to the hatch.

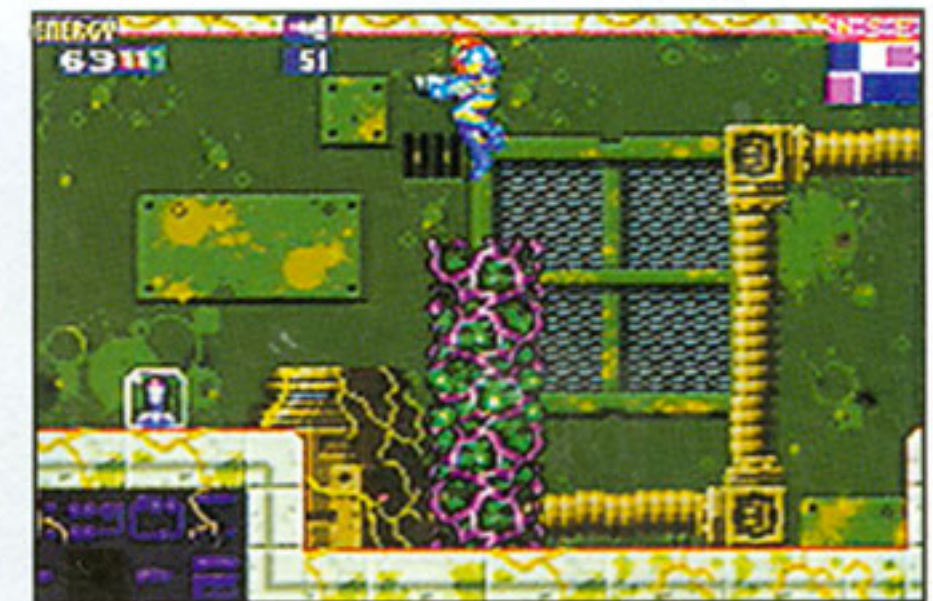
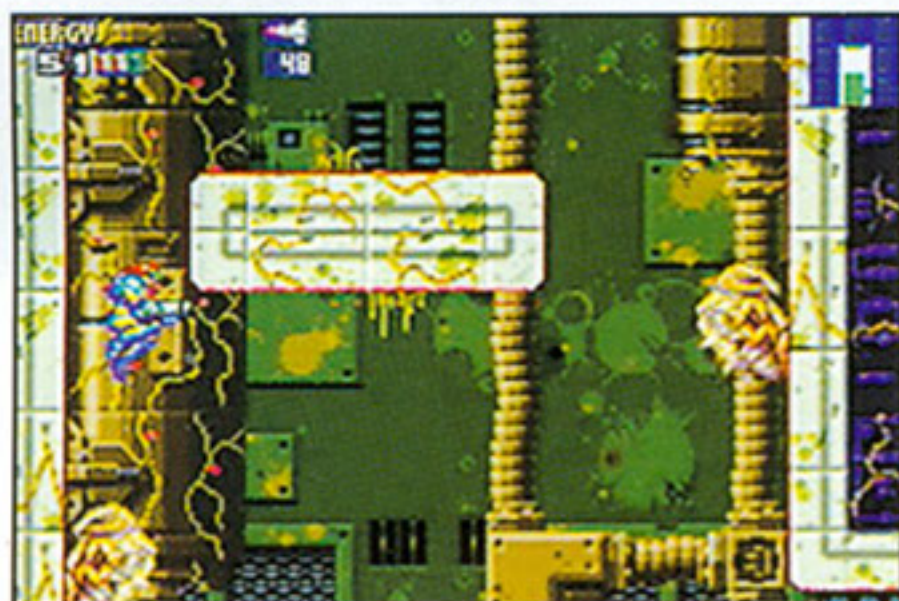

13 UP AND OVER

An offshoot passage near the top of the sector has two living walls. Using your advanced jumping ability, you can leap over both creatures and collect the Missile Tank on the other side.

SECTOR 4

AQA

The SA-X has taken advantage of the Level 1 security breach and has imported the X parasites to the water habitat, Sector 4. You must go there to restore order.

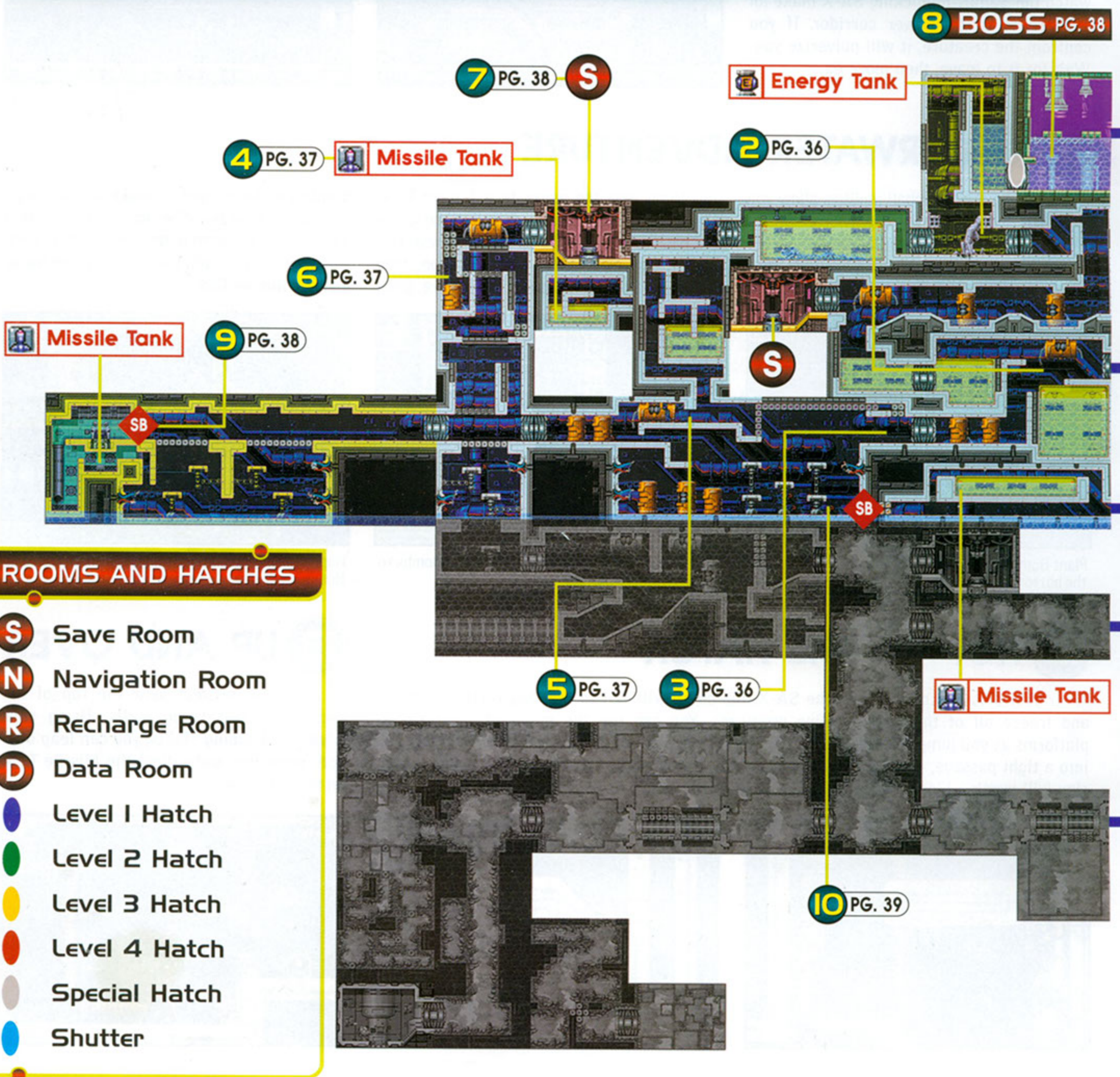
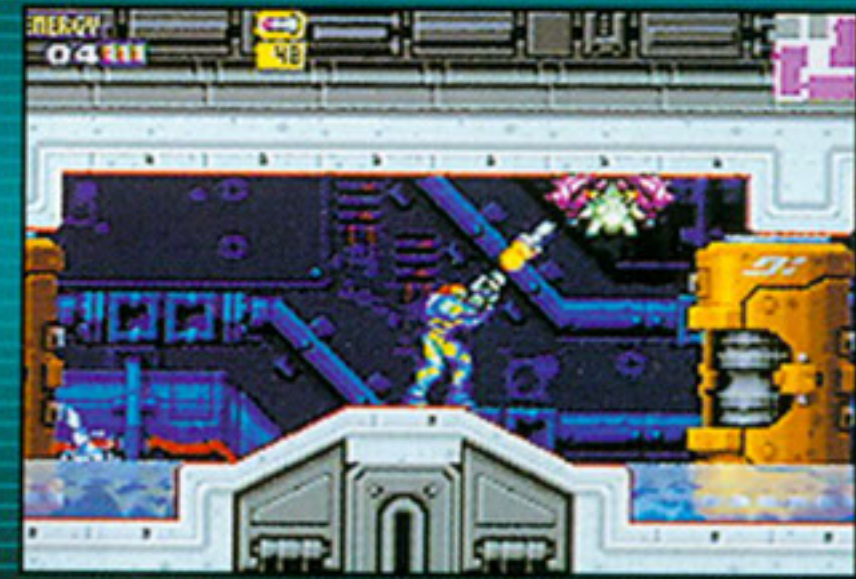

BLOCKS

- B** Bomb Block
- PB** Power Bomb Block
- M** Missile Block
- SB** Boost Block
- SA** Screw Attack Block

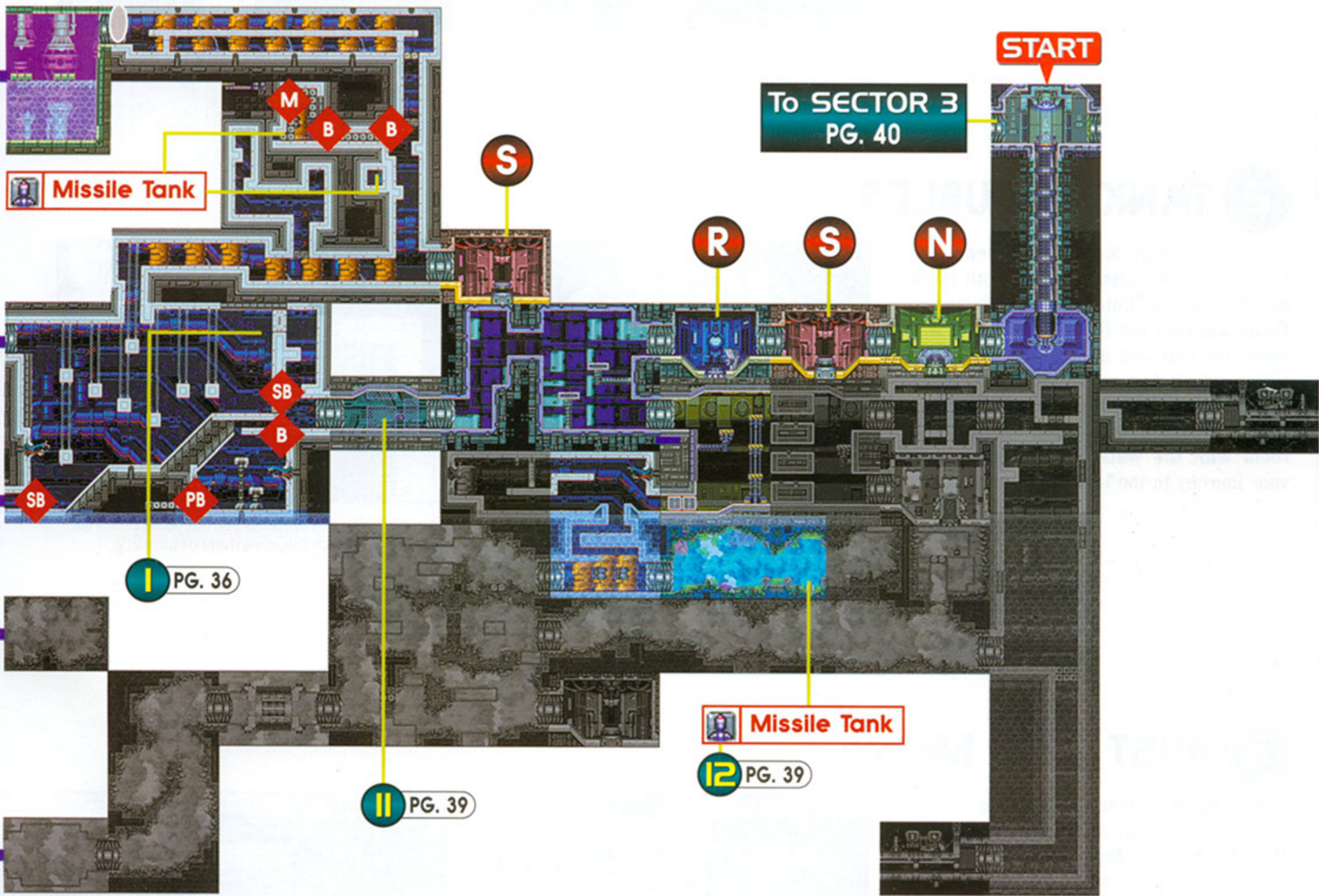

FIRST OBJECTIVE Find and terminate Serris.

1 CLEAR THE WAY

When you reach the room that has a vertical section on its right side, climb to the top, then roll up, jump up in ball form and plant Bombs to destroy a section of the wall. Grab the horizontal ladder on the ceiling and climb cautiously to the left. As soon as you see the crablike creature that crawls along the ceiling, hit it with Beams or Missiles. When you get to the left end of the ladder, drop onto a platform and continue on to the left side of the room.

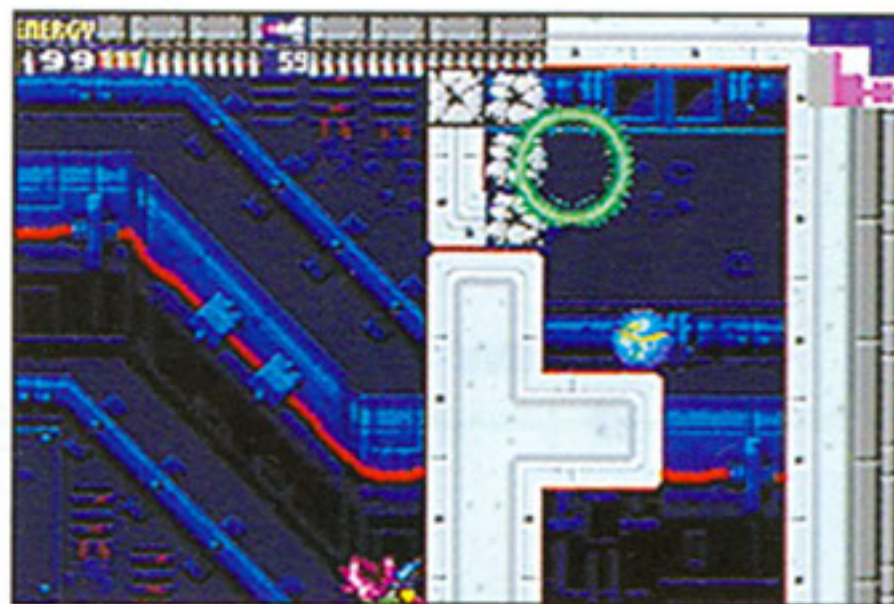

Jump up in ball form and set bombs in the air, next to the wall. The explosion will break through the wall.

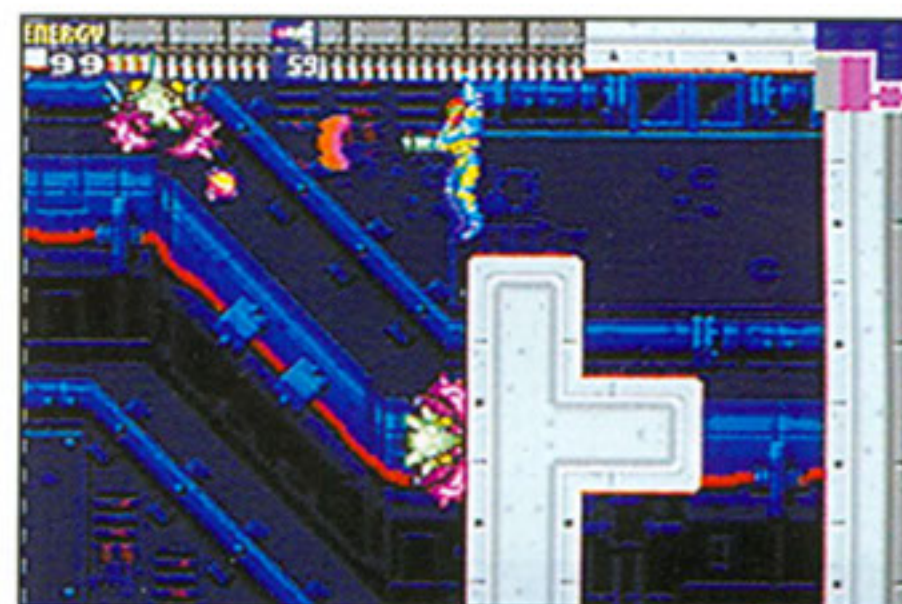

Blast the beast on the ceiling before it gets close enough to attack.

2 TANK TROUBLES

The section that has large, green water tanks is packed with enemies, both in and out of the water. Enter the room firing your Beam and take out the creatures that walk along the platform and ceiling. Jump over the first tank, hop across the top section of the room and take a detour up to an Energy Tank and Save Room. Then return to the room with the water tanks and continue your journey to the left side of the sector.

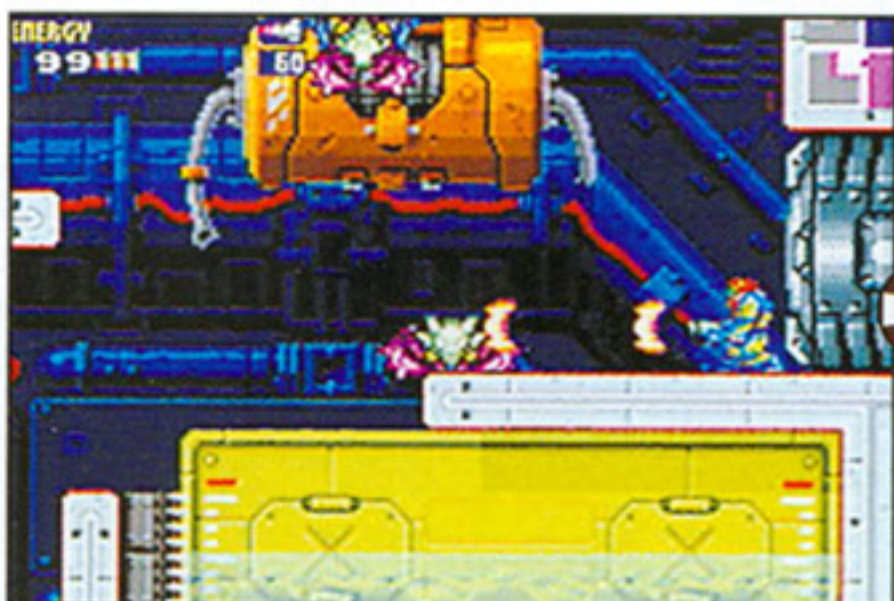

As soon as you enter the room, train your weapon on the enemies near the hatch and fire away.



Don't fall into the water. If you do, you'll find that the enemies have the advantage of mobility.

3 BUST AND MOVE

The horizontal ladder in the long, flooded room is covered by a series of blocks. Fire straight up at the four-square block collection, then jump up, roll to the left and plant a Bomb. The explosion will set off a chain reaction that will destroy all of the blocks on the ceiling and give you access to the ladder. Jump up, grab the ladder and climb to the left, over the water. When you get to the other side, jump up through a hole in the ceiling for a quick detour that will net you a Missile Tank (see tip 4).

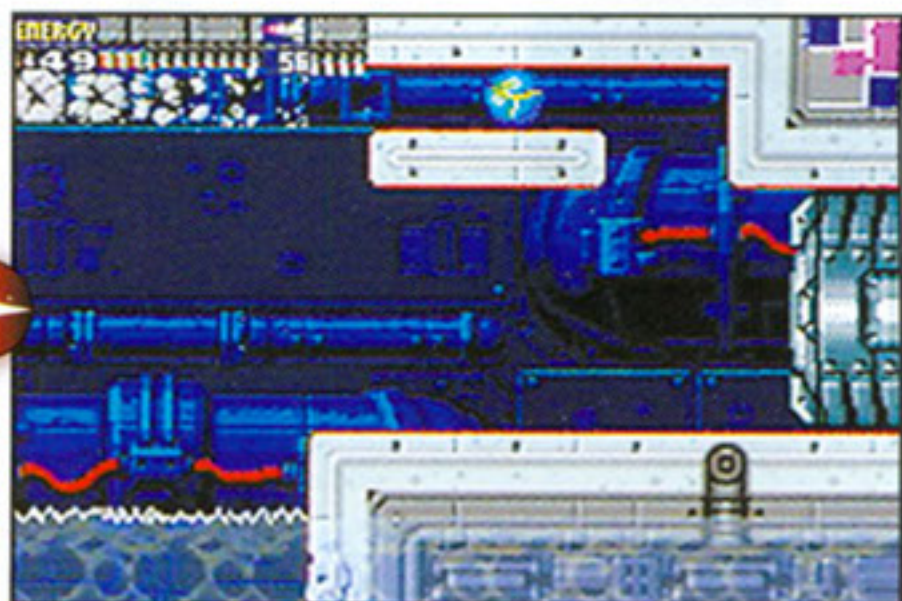
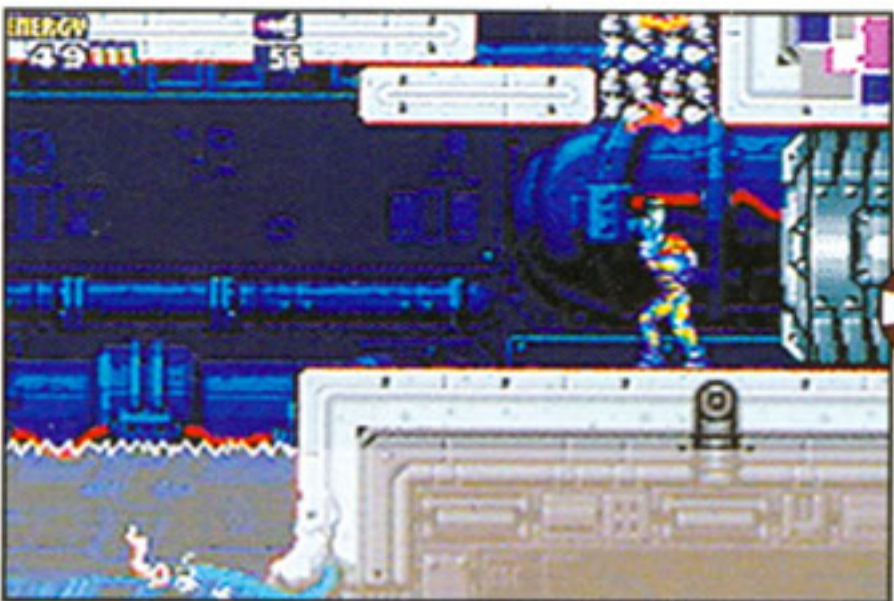

4 MISSILE TANK HIDEAWAY

When you enter the room that has a ladder on each of its walls, you may find it to be a puzzling dead end, as there are no blocks to blast through, items to collect or enemies to fight. With careful exploration, though, you will discover a secret passage. Climb to the top of the ladder on the left side of the room and press Up on the Control Pad to transform into a Morph Ball. Roll to the left and into a room that contains a Missile Tank.

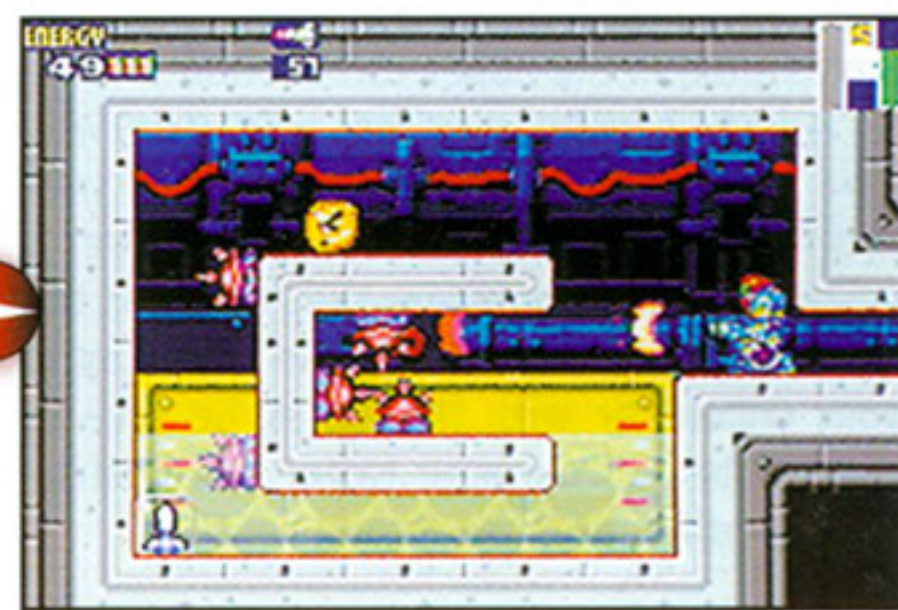
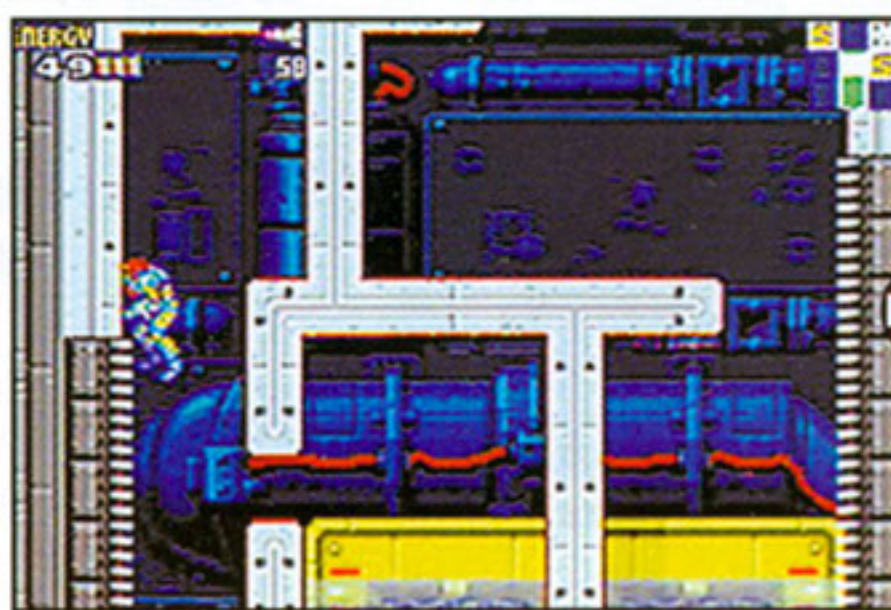

5 DROP AND DETONATE

After you return to the main passage from your Missile Tank detour, roll up and set a Bomb against the left wall. The blast will destroy two blocks. Roll to the left and plant another Bomb to destroy the next two blocks and clear the passage to the left side of the room. Keep moving. You're closing in on the holding tank for the deadly Serris.

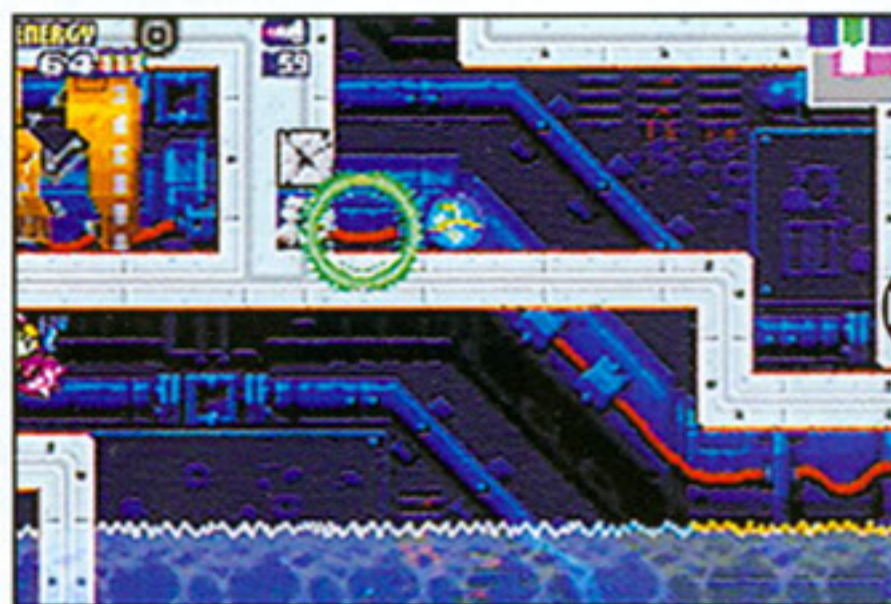

Drop down into the room that is flooded with electrified water, and blast through a barrier.

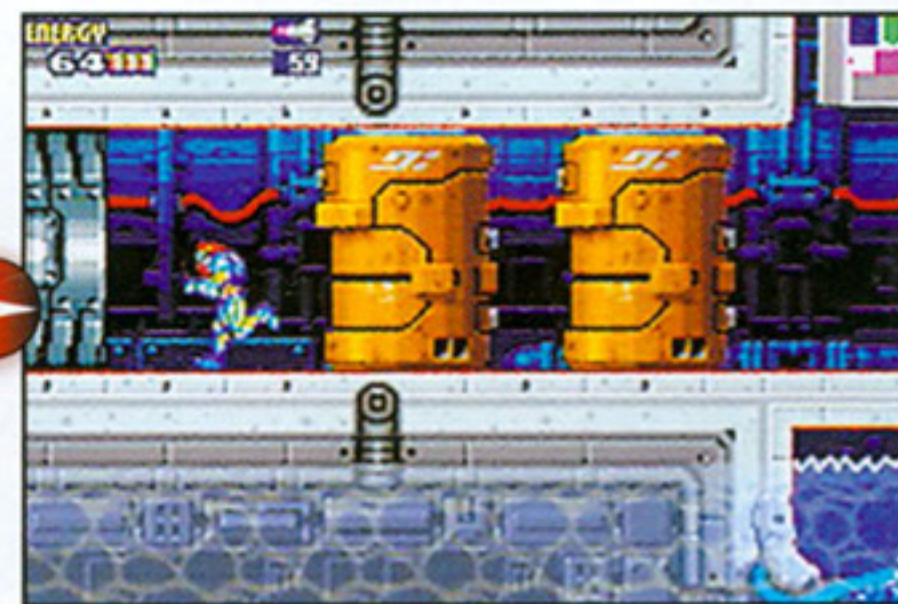

Run to the left and make tracks for a long, vertical passage.

6 TOP IT OFF

When you enter the bottom section of the long, vertical passage, you'll be tempted to explore the Pump Control Unit beyond the hatch to the left, but you won't be able to go far until you have the Speed Booster. Stand

near the hatch on the right and fire straight up to break through to a ladder on the left side of a narrow passage. Climb up, destroy more obstacles, blast enemies with your Beams and continue on your way to the top

of the passage. Don't pass up an opportunity to climb across a horizontal ladder. If you opt to drop and walk across the blocks, you may fall through the floor and lose some progress.



At the bottom of the vertical passage, fire straight up to clear the way for your climb.

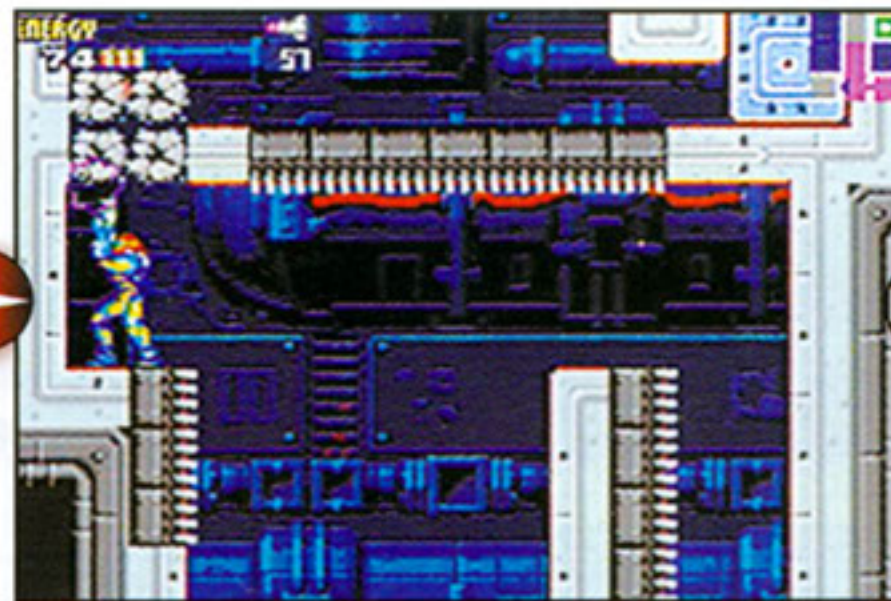

You'll find several four-square blocks that you can destroy with your Beam. Keep blasting.

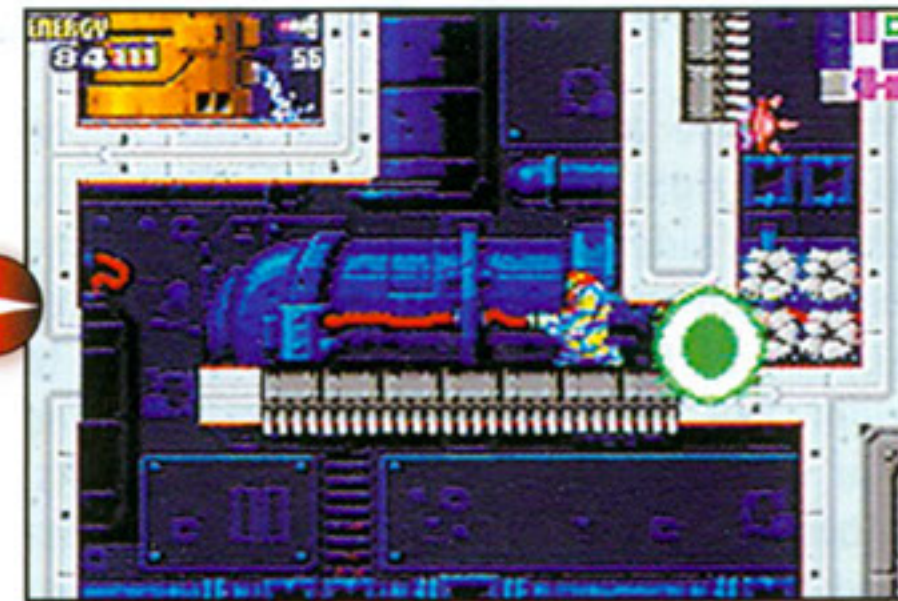

You can use Bombs or your Beam to destroy some of the obstacles.

7 SAVE THEN DESTROY

Save Rooms are, by and large, dead ends with no opportunities for discovery. The Save Room in the upper-left section of Sector 4 is an exception to that rule. After you save your game data, face the right wall and fire. You'll break a block and uncover a passage to the laboratory that contains the quick and dangerous Serris. On your way to your encounter with the beast, be sure to collect the red parasite (after you destroy the eyeball guard) for a tank refill.

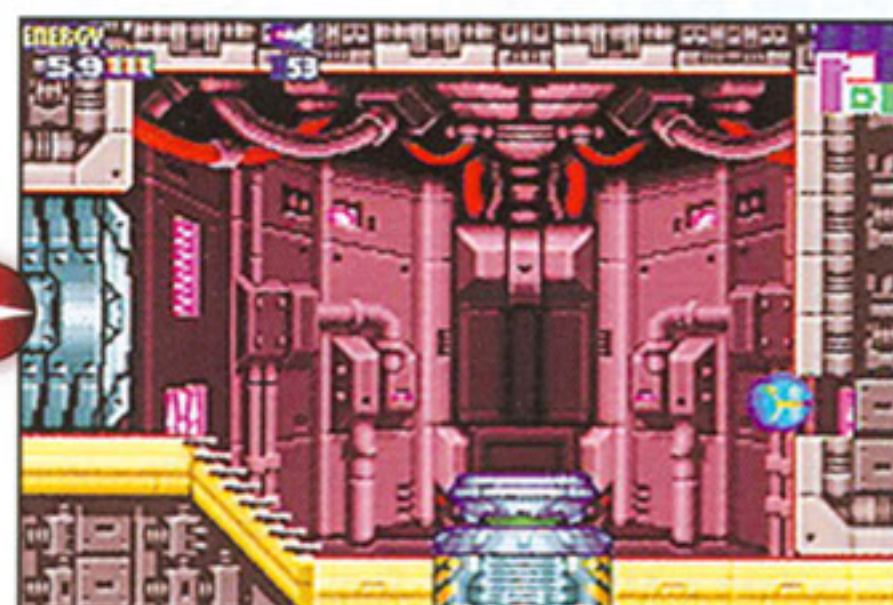

8 BOSS BATTLE

Serris swims swiftly through the water of its big tank and jumps high into the air. After you awaken the creature, drop down and look for a safe spot, face the middle of the tank, crouch and charge up your

Beam. When you have a clear shot of Serris's head, release the Beam. After a direct hit, Serris will glow white and tear around the tank in a rage for a few moments, during which it will be invulner-

able. Wait it out and prepare for another shot. Once Serris is gone, you'll fight a Core-X for the Speed Booster.



As soon as you enter the boss battle arena, run along the platform on the surface of the water.



Charge your Beam, take a shot, wait and repeat.



SECOND OBJECTIVE Activate the Pump Control.

9 DASH TO THE UNIT

You'll have a chance to test your Speed Booster right out of the blocks. Exit from the right side of the boss arena into a long hall. Clear away the enemies in the lower section of the hall, then run from left to right. The Speed Booster will activate, and you will break through two Boost Blocks. Move on to the Pump Control Unit room and bust through blocks to the pump controls. Activate the pump to lower the sector's water level.

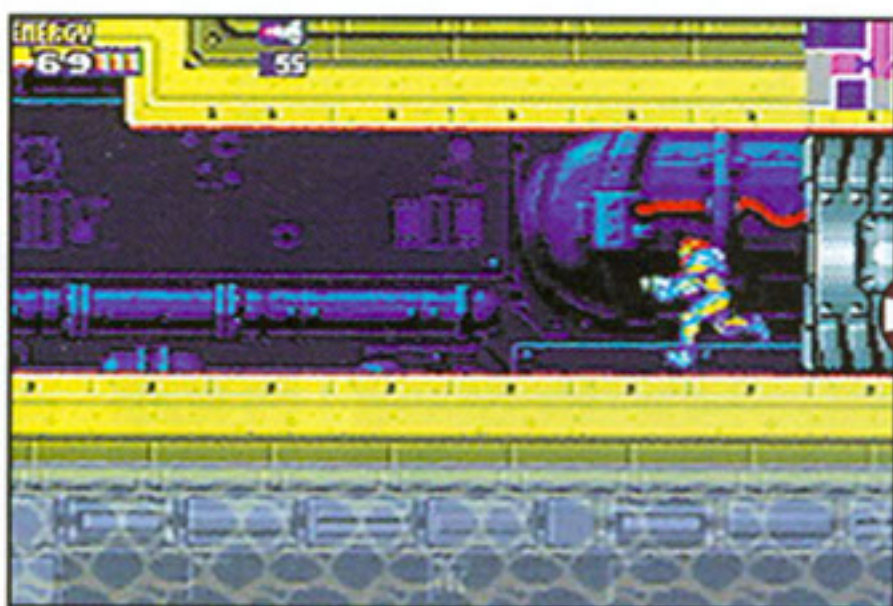

Shoot the hatch and enter the Pump Control Unit room in the leftmost section of the sector.

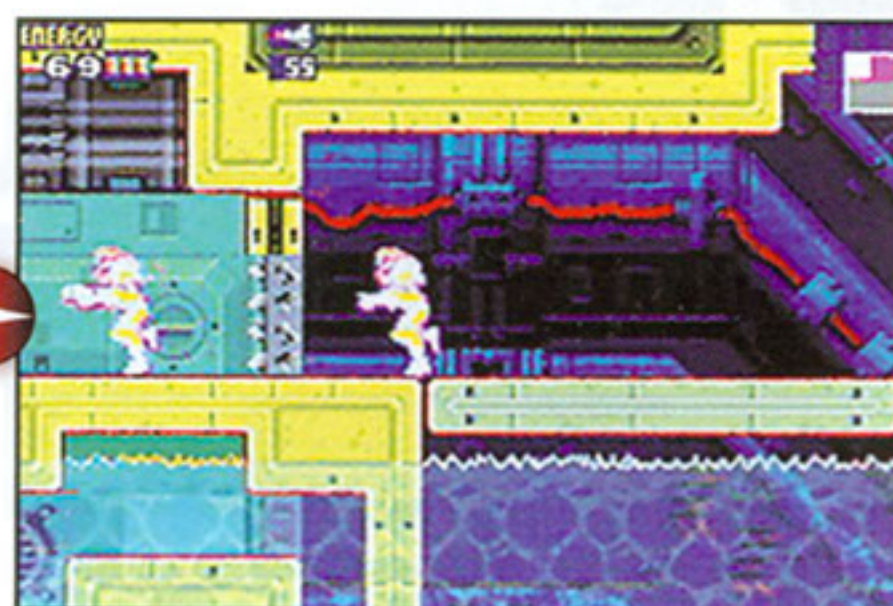

When the Speed Booster charges up, you'll glow white and run through Boost Blocks.

THIRD OBJECTIVE Explore the newly drained Sector 4 areas.

10 THE LONG RUN

With the water level lower in the central section of Sector 4, you'll discover some interesting, unexplored areas. When you drop to the floor of the drained section and detonate Boost Bombs near some walls, you'll discover Boost

Blocks. Clear the floor of enemy creatures, give yourself a good running start and blast through the blocks with the power of the Speed Booster. As you blaze through the area at turbo speed, you'll also wipe out every

enemy in your path. One section in the middle of the path did not appear previously on the computer's map. If you stop to investigate the area, you'll discover a path to a stray Missile Tank.

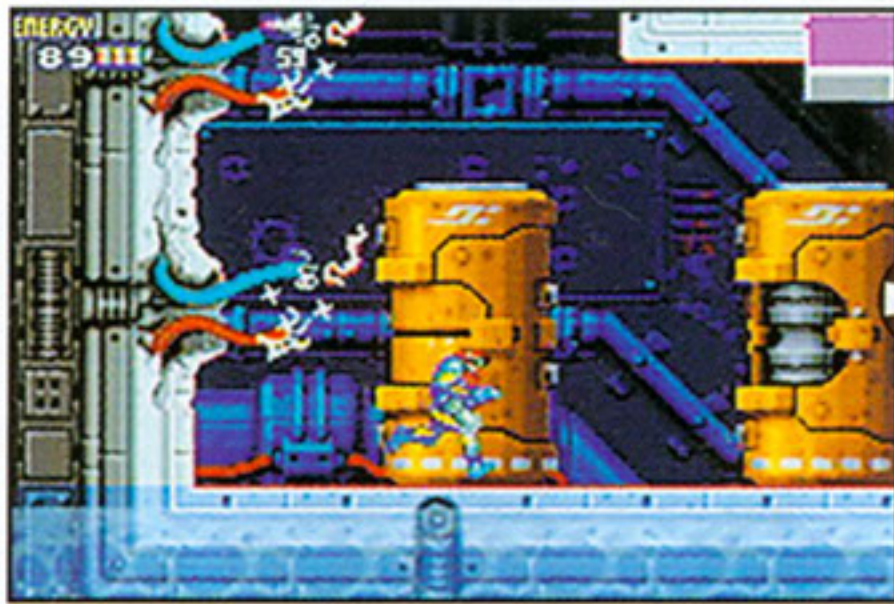

Start from the lower-left corner of the drained area and run to the right.

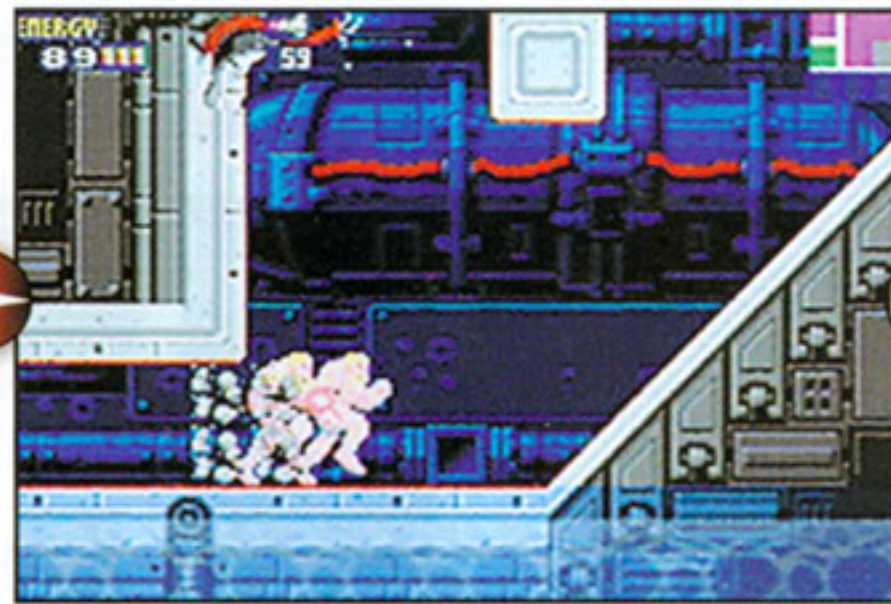

As soon as you begin to glow, your speed will increase and you'll blow through Boost Blocks.

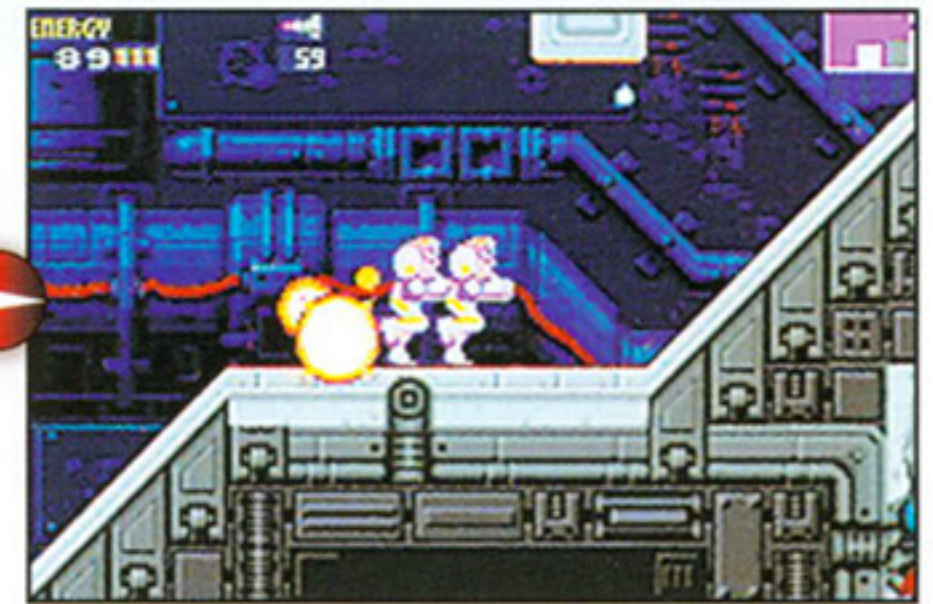

The power of the Speed Booster allows you to run right through enemies.

11 PARASITES FOUND

A crablike creature patrols the room that connects the middle section of the sector with the right section. As soon as you enter the room, both hatches will lock. Defeat the creature to expose its X parasite. The organism will float to the ceiling and reform as a gold-colored crab that is protected from standard Beam shots. Hit it with charged Beam fire or two Missiles. Once you destroy the creature, the doors to the room will unlock.

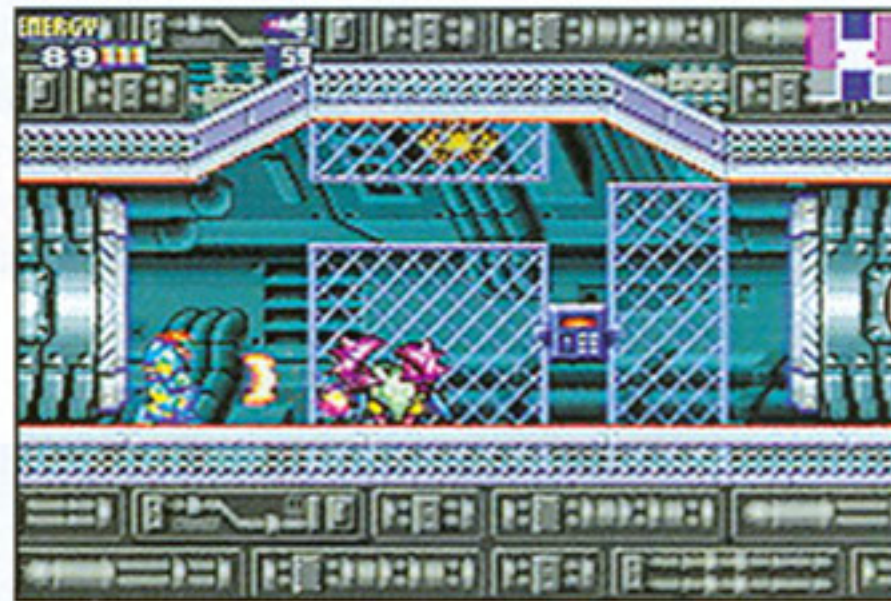

Blast the creature in the locked room to expose a particularly resourceful X parasite.

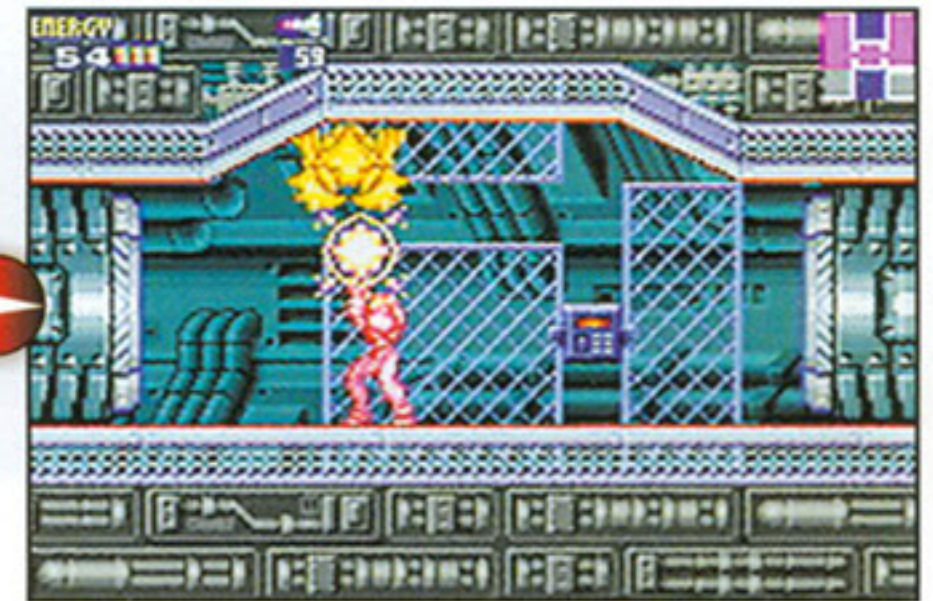

After the parasite regenerates into an armored creature, hit it with a charged shot.

12 WATER WARRIORS

If you take a detour to the water-filled area in the lower-right section of Sector 4, you'll find several thick-skinned creatures that shoot powerful blasts with diagonal trajectories. You can defeat each of the creatures with several charged shots or Missiles, but it's best to leave them alone. Avoid their blasts and pick up a Missile Tank. After you collect the Screw Attack and Gravity Suit (later in your adventure), you'll be able to explore the area more thoroughly.

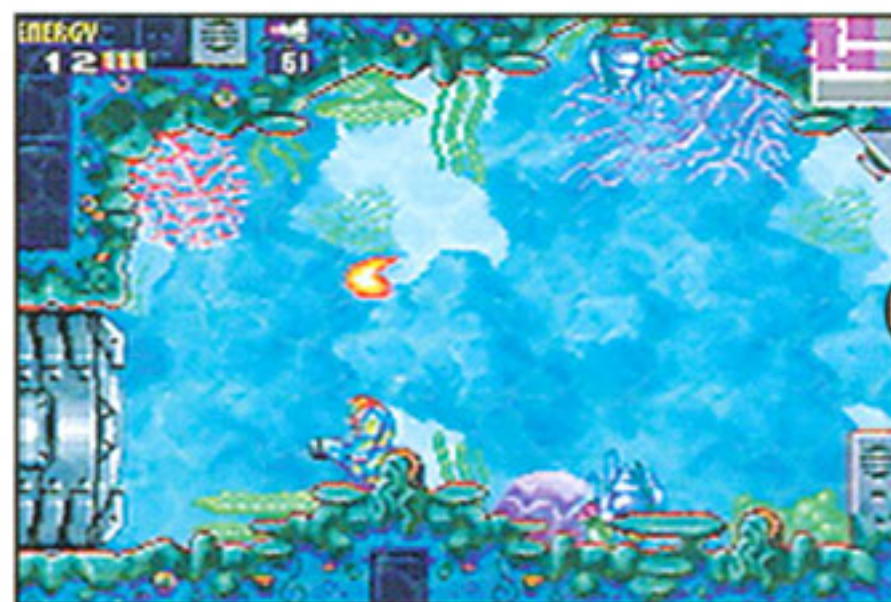

Watch the tough-to-defeat creatures and avoid their diagonal shots.



Collect the Missile Tank, then retreat. You'll need the Screw Attack to go any farther.

SECTOR 3

PYR

Sector 3 is a relatively safe place for data download, with no X parasites in the region—yet. Once you unlock security hatches, though, prepare for an X epidemic.

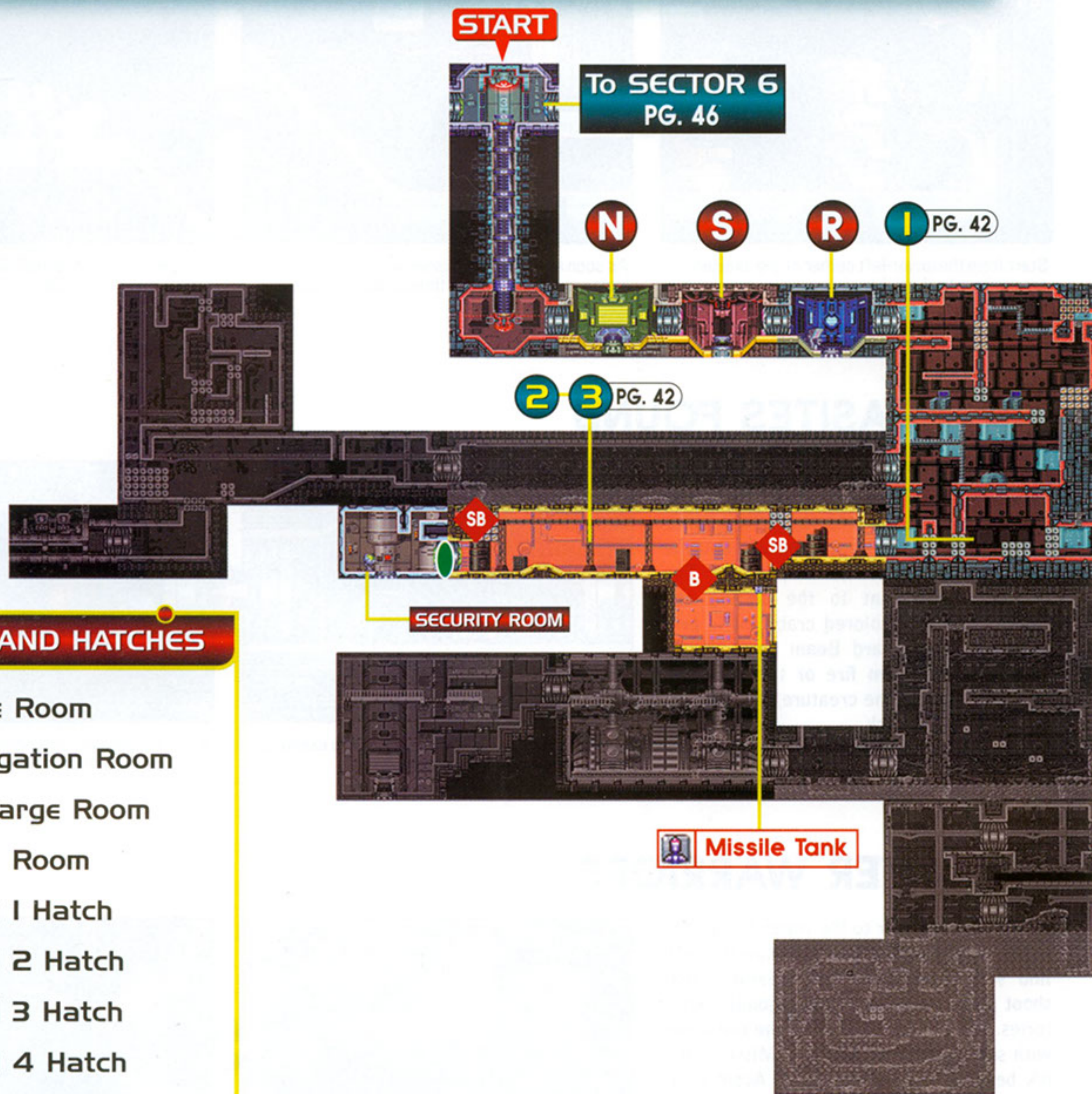
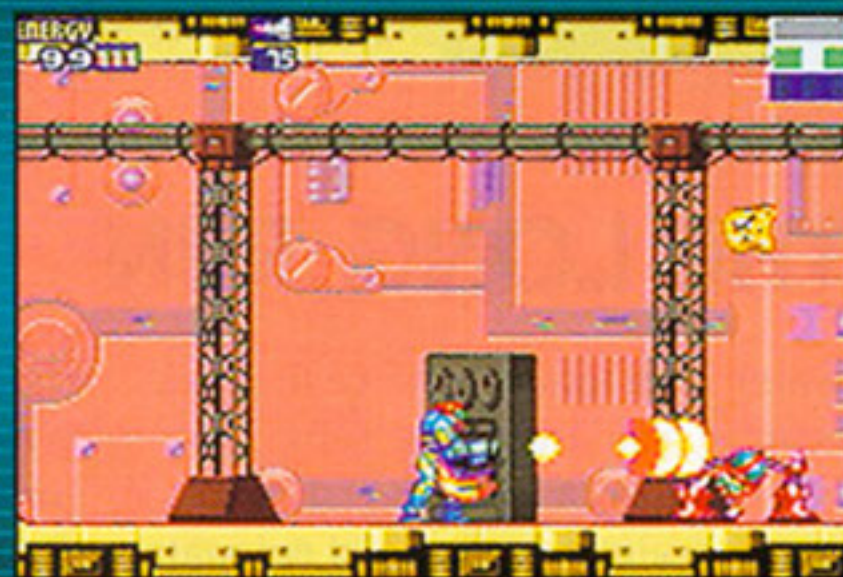

ROOMS AND HATCHES

- S** Save Room
- N** Navigation Room
- R** Recharge Room
- D** Data Room
- Level 1 Hatch
- Level 2 Hatch
- Level 3 Hatch
- Level 4 Hatch
- Special Hatch
- Shutter

- BLOCKS**
- B** Bomb Block
 - PB** Power Bomb Block
 - M** Missile Block
 - SB** Boost Block
 - SA** Screw Attack Block

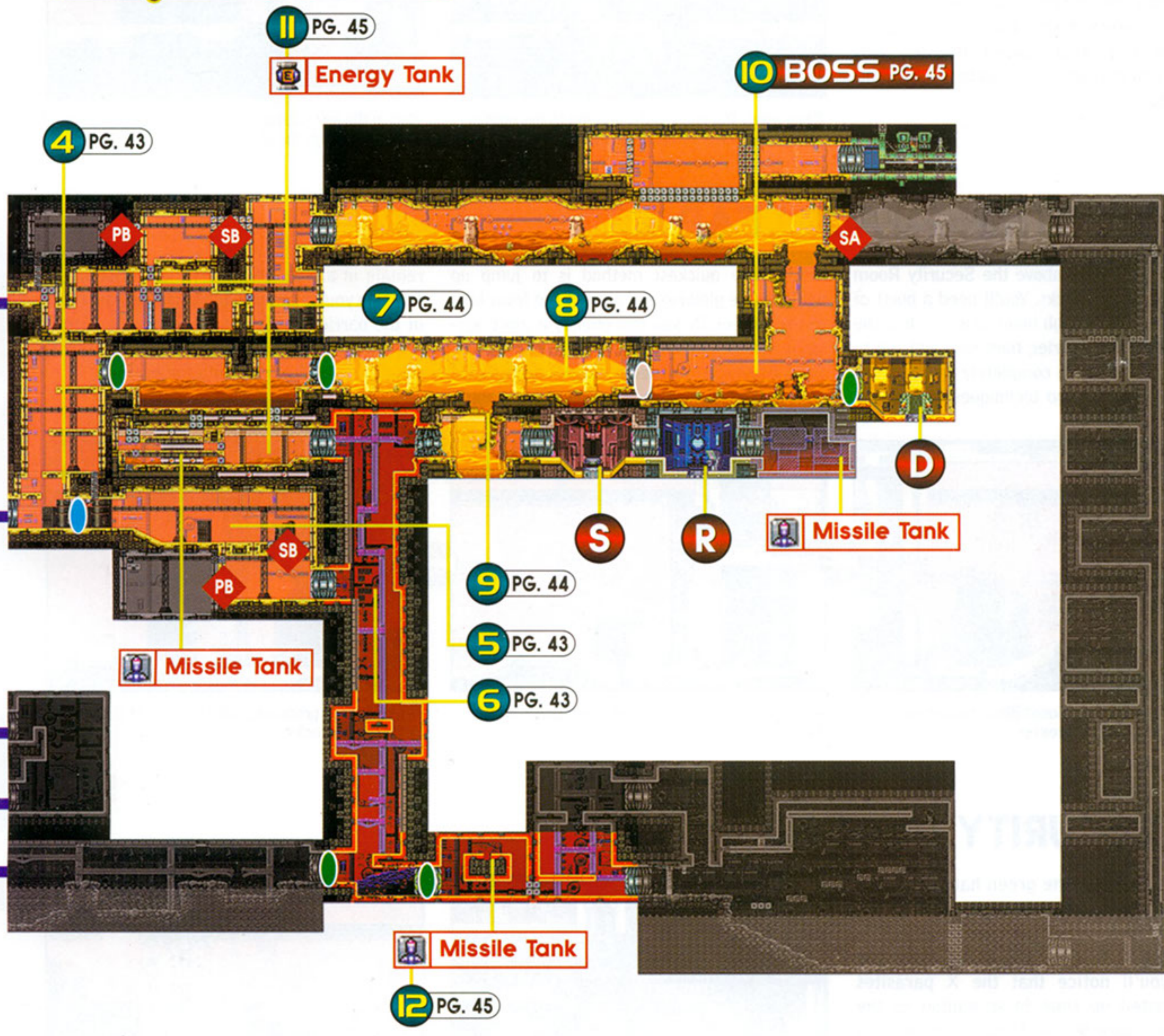

FIRST OBJECTIVE Locate the Security Room and activate Level 2 hatches.

1 A NEED FOR SPEED

As you attempt to advance to the location of the Level 2 Security Room, you'll run into a barrier of Boost Blocks. You'll need a long running start to destroy the blocks with your Speed Booster ability. Return to the area to the right and use your Beam to clear away the lower section of the walls. When you reach the next hatch, turn to the left and run. Your Speed Booster will engage just in time for you to break into the next area.

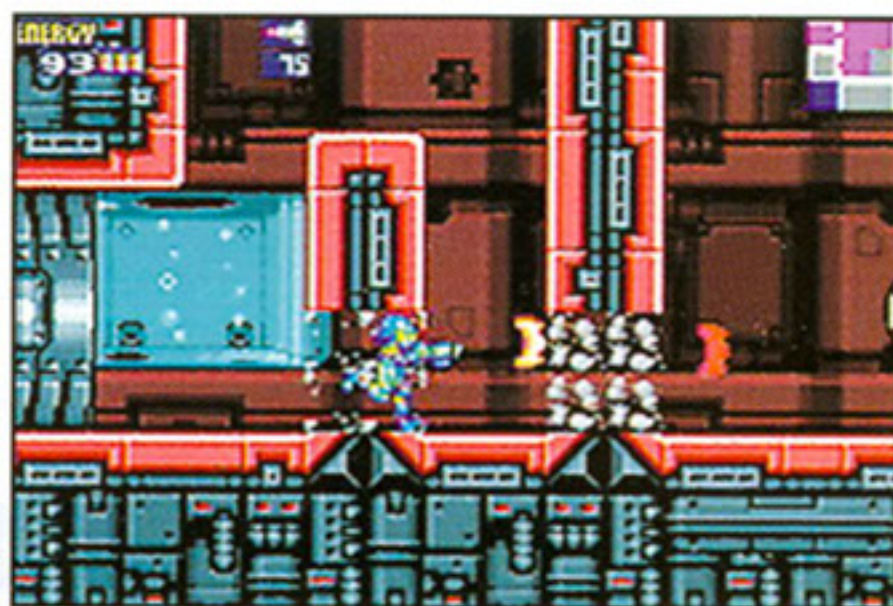

Clear away the walls in the section to the right of the hall with the Boost Block barrier.

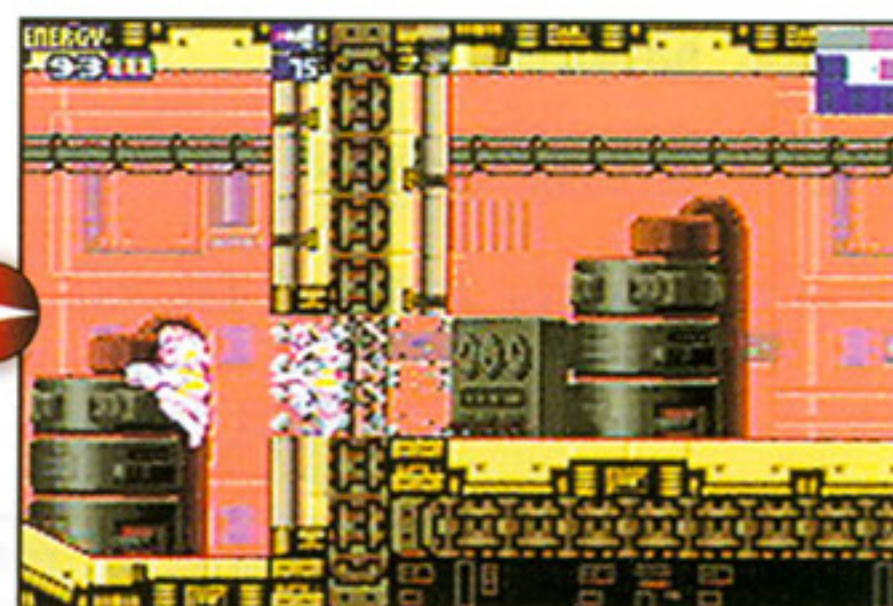

Run to the left, charge up your Speed Booster and scream through the blocks.

2 LIGHTNING-FAST LEAP

Many of the blocks above the Security Room hatch are Boost Blocks. You'll need a burst of speed to break through them. Backtrack to the last Boost Block barrier, then turn and run to the left. When you're completely charged, you can use either of two techniques to bust the

blocks. The quickest method is to jump up while you're glowing and aim for the front face of the barrier. Or you can employ a more versatile method, which also works in other situations. As soon as you begin to glow, press Down on the Control Pad to stop and crouch. You'll

remain in a charged state for a few seconds. Position yourself under and slightly to the right of the barrier. Press the A Button, then press and hold Up and Left on the Control Pad to initiate a rocketlike boost into the barrier.

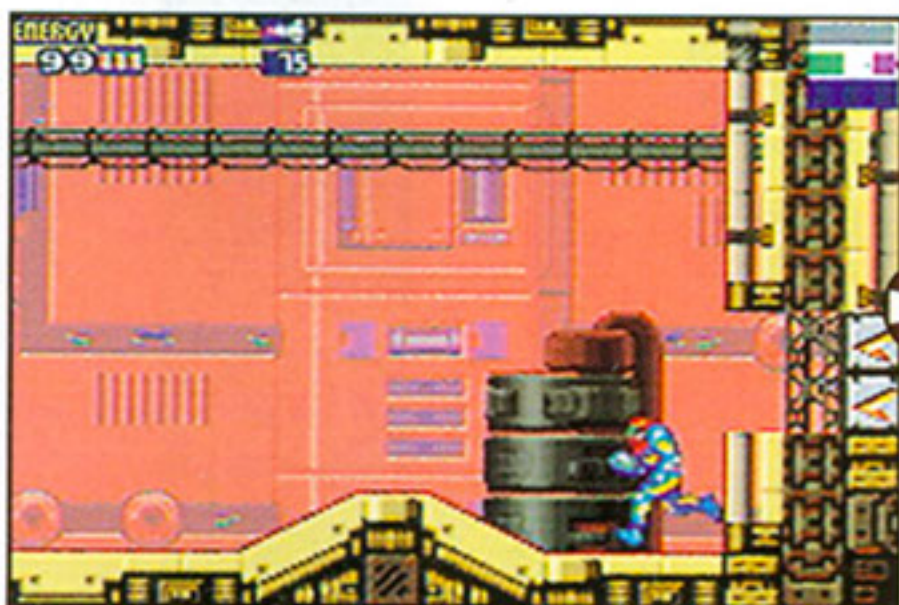

Run left from the last Boost Block barrier and charge up the Speed Booster.

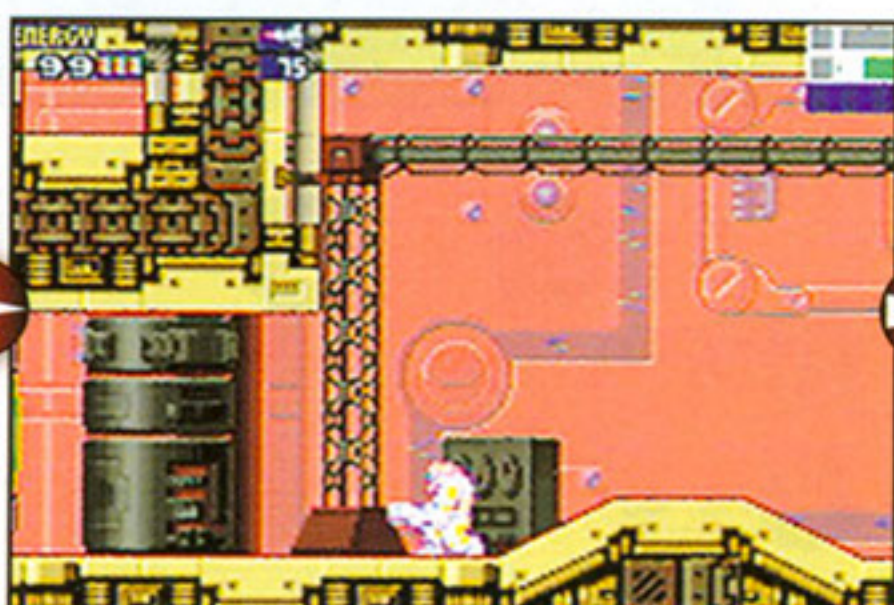

As soon as you begin to glow, press Down on the Control Pad to stop and crouch.

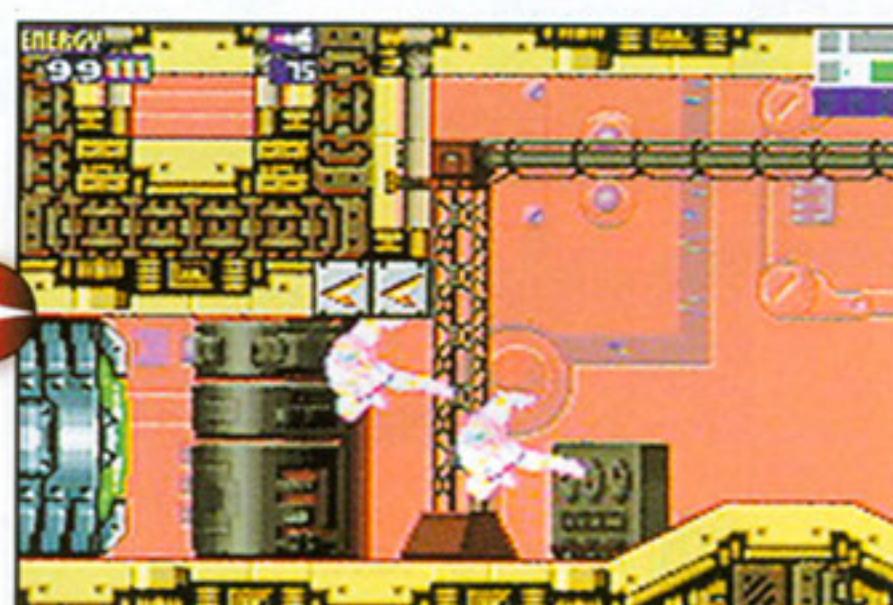

Press A, then press and hold Up and Left to blast off into the blocks.

3 SECURITY UNDONE

Jump up and over the green hatch to reach the Security Room, then hook up with the computer and unlock all green hatches in the research station. When you leave the room, you'll notice that the X parasites have wasted no time in spreading to the newly unsecure sector. If you start running as soon you enter the hall, you'll be able to get through the area before the parasites can form into enemies, and you'll charge up the Speed Booster for a blast.



When you step onto the Security Room pad, you'll unlock all Level 2 hatches.

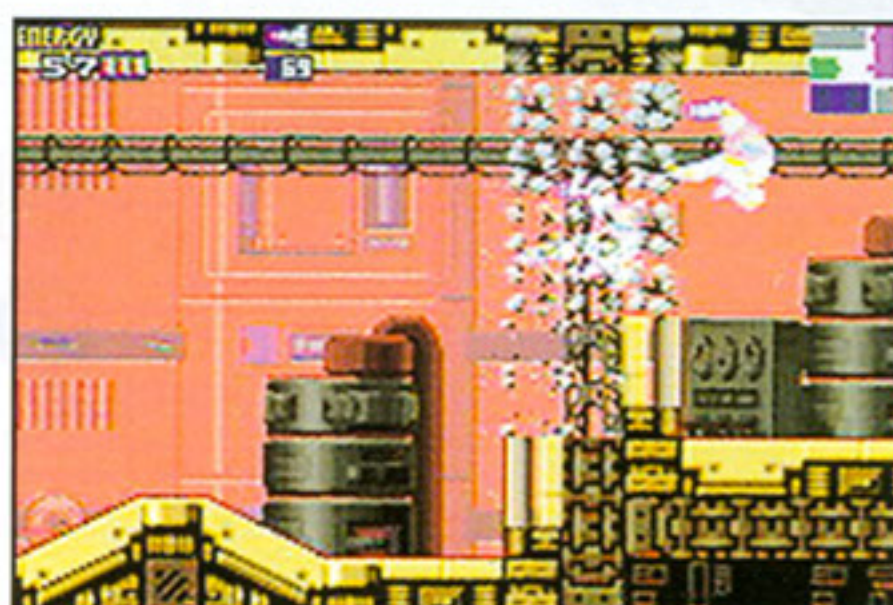

Leave the Security Room and start running immediately. You'll avoid enemies and bust through a wall.

SECOND OBJECTIVE Proceed to the Data Room.**4 SHUTTER SHOWDOWN**

On your way to the Data Room, you'll find yourself on the wrong side of a one-way shutter. Jump up to the ledge above the shutter and face off with a large, green creature that is attached to the wall. The creature will extend its neck, but it won't fire projectiles. Stand at the edge of the ledge and hit the beast with Charge Beam shots or Missiles. The defeated creature will leave behind two tank-refilling parasites. Grab the parasites and run over to the wall. You'll drop through the floor to the other side of the shutter.

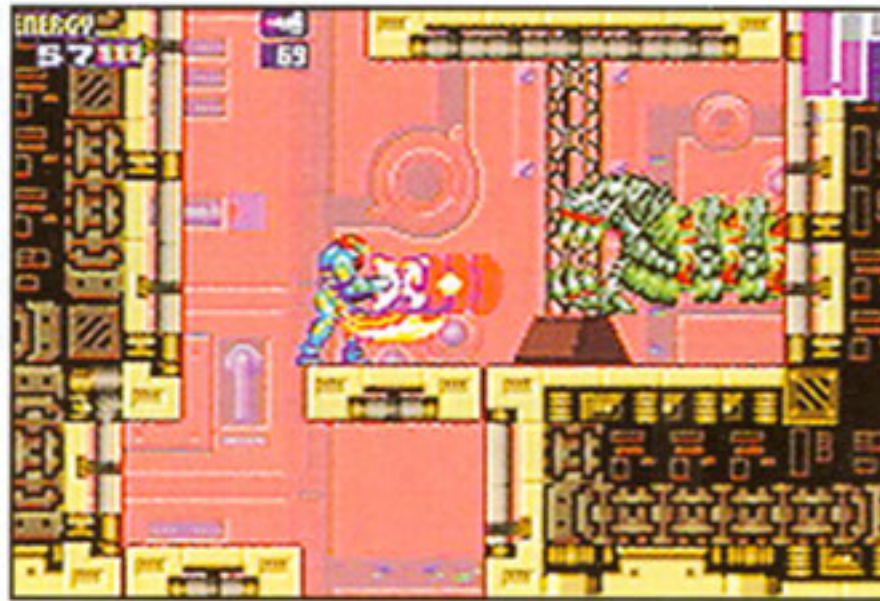

Stay at the edge of the ledge and hit the creature with as much firepower as you can muster.

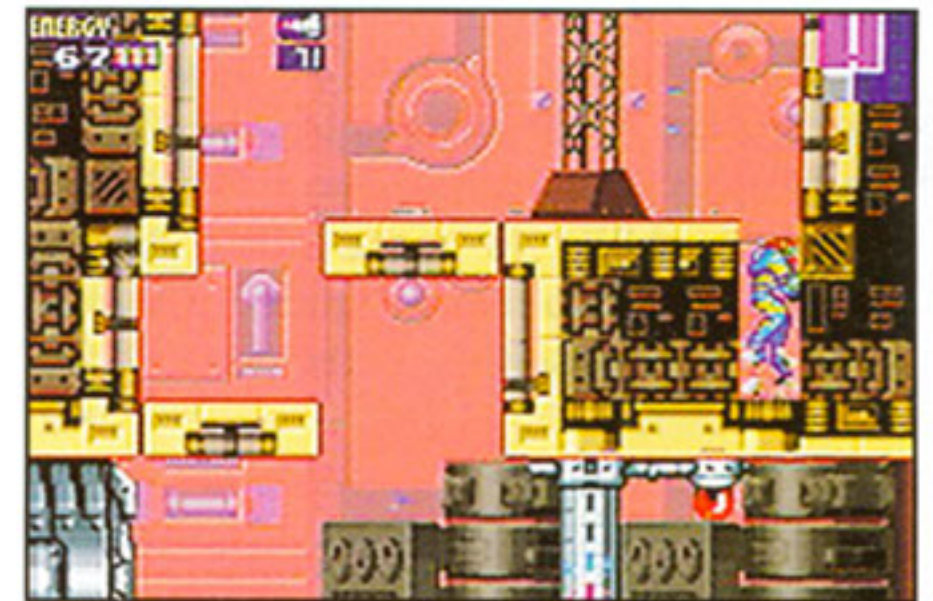

When the creature is gone, run to the right and fall through the floor.

5 RUN AND WRECK

The room on the other side of the shutter appears to be a long dead end. If you investigate the area carefully, you'll discover Boost Blocks on the floor at the end of the hall. Return to the last room that you were in, open the shutter and run to the left side of the room. Turn around and run to the right. Your booster will charge up, and you will burn through the blocks at the end. One of the blocks that you expose will break when you stand on it.



Open the shutter, run to the left, then turn and run to the right. You need the space to charge your booster.

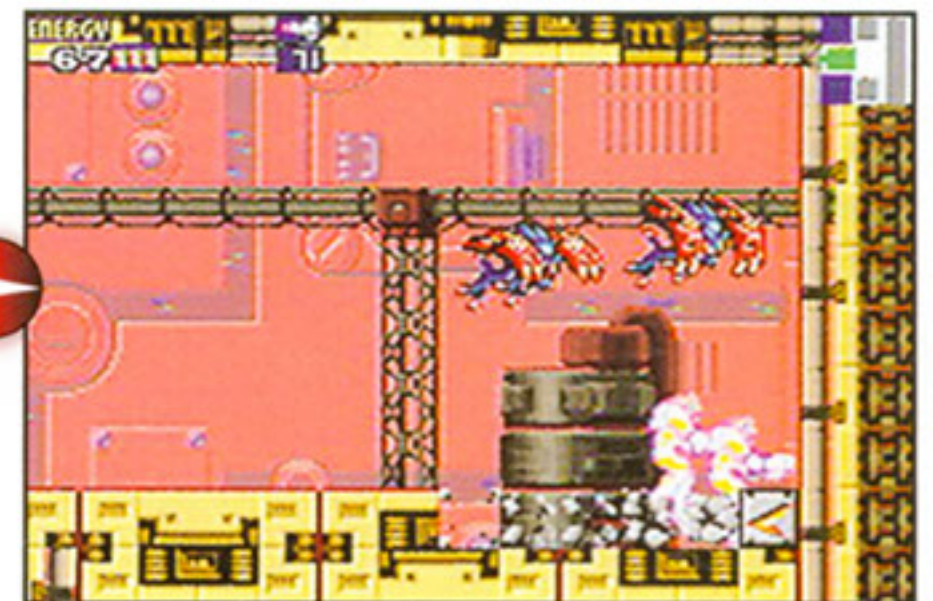

When you reach the end of the hall fully charged, you will break through a layer of blocks.

6 TALL ORDER

Creatures of the type that you fought above the shutter populate the vertical passage on the right side of the sector. The enemies will extend from the wall when you climb to their level, and some will fire obstacles from their mouths. You can battle them with Charge Beam shots or Missiles. As you climb and encounter the creatures, try to hit them from below, at an angle. They won't be able to fight back, and you'll win your battles easily.

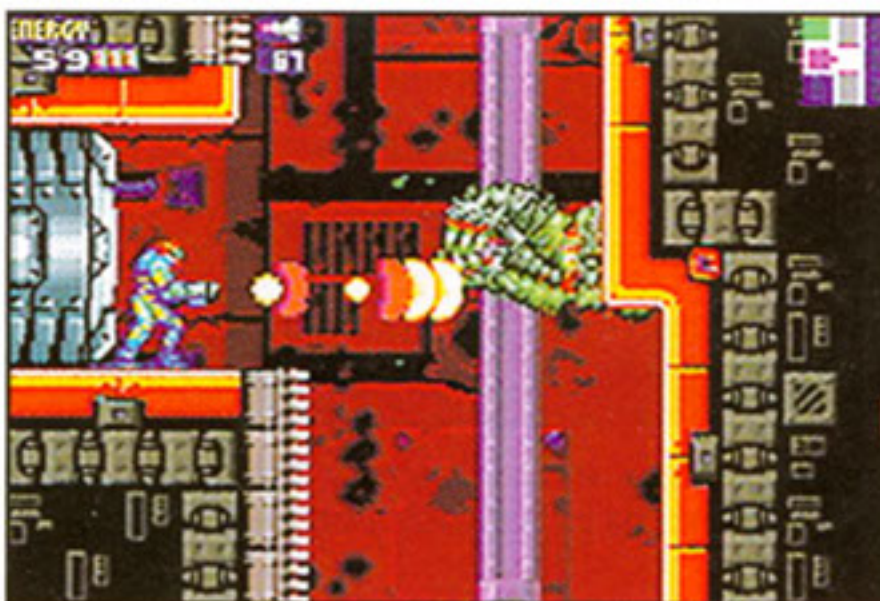

As soon as you enter the vertical passage, stop and charge your Beam, then fire away at the first beast.

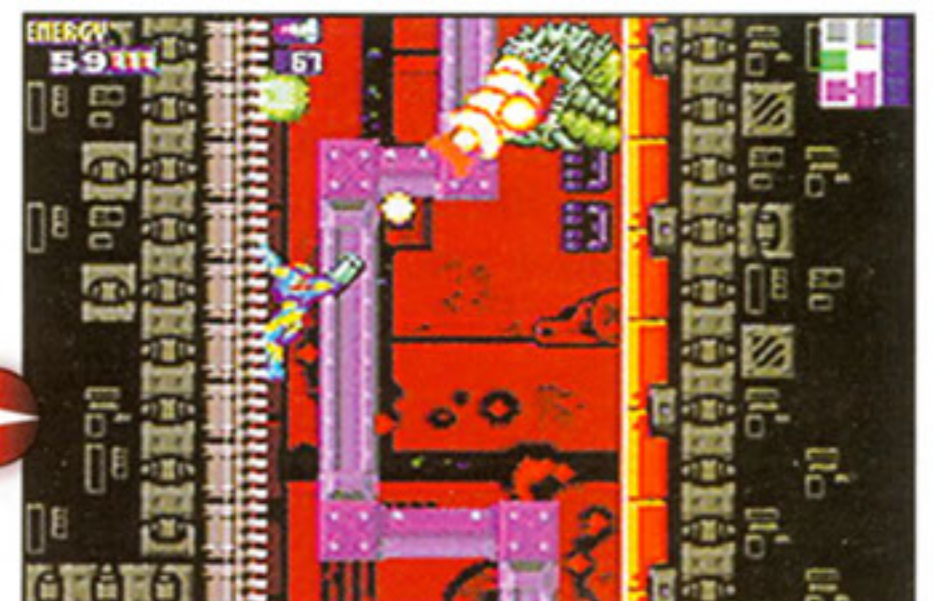

Climb up and fire on the long-necked creatures using a diagonal approach.

7 TAKE THE HIGH ROAD

After you reach the top of the vertical passage and go to the left, you'll find a wall that has two narrow passages. You can break into both passages by using Bombs. If you take the lower passage, you'll drop through the floor and into the lower hall. Roll into the upper passage instead. Collect the Missile Tank, then use your Bombs and Jumpball ability to make your way up through a series of blocked pipes to a green hatch. You're closing in on the Data Room.



Hop up in Morph Ball form, set a Bomb and blast your way into a high passage.

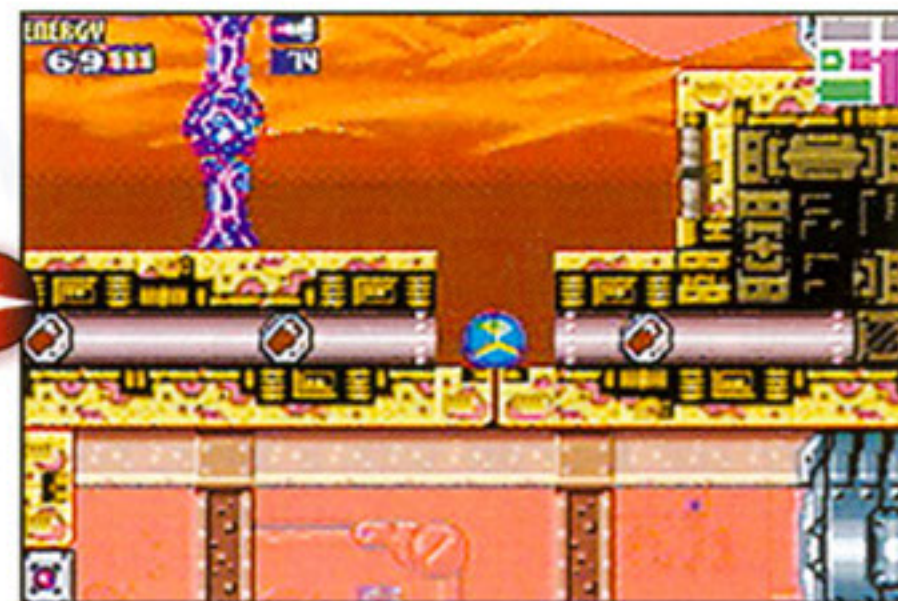

Roll, blast and climb up to the top of the sector. You'll find a green hatch in the open air.

8 SUPER MISSILE SUNSHINE

The lights shine brightly in the desert environment at the top of the sector. You'll encounter large, hopping creatures and small fiery enemies on your way to the Data Room. Clear away the enemies with Charge Beam shots and run to the right. When you reach the Data Room, step on the pad and download the Super Missiles. The upgrade will triple the power of your Missile supply automatically.



The desert environment enemies are thick-skinned. Hit them with your most powerful weapons.



After you complete your desert trek, you'll download the Super Missile upgrade.

THIRD OBJECTIVE Save game data and recharge.

9 DROP AND SAVE

Return to the desert environment and run to the left. When you reach the left end of the path, you'll hear a desert-rocking sound. An explosion will have changed the landscape. Move to the right to find a large hole in the ground. Drop into the hole and work your way to the right to a Save Room, a Recharge station and a room where you will find a Missile Tank.

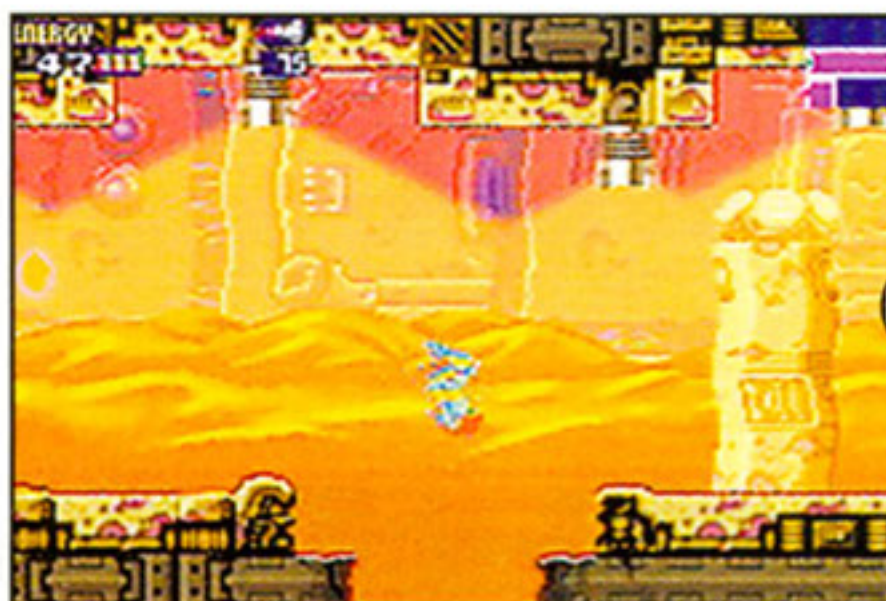

After you hear the explosion in the desert, you'll find a hole in the ground. Drop in and investigate.



Save your game data, recharge, then blow away an obstacle and collect a Missile Tank.

FOURTH OBJECTIVE An unknown event has occurred. Investigate.

10 BOSS BATTLE

After you save and recharge, return to the vicinity of the Data Room. You'll encounter a security robot—the only enemy that has not been consumed by an X parasite. Run to the

left, jump up and grab the horizontal ladder on the ceiling. When the robot stops and rocks back and forth on its legs, fire down on it with Super Missiles. After a moment, the

robot will launch a small, explosive ball. Hit the ball with Missiles or stay directly above it to avoid its fire-wave blast. Continue to fight the robot until it explodes.



Return to the area near the Data Room. The music will change, and you will discover a security robot on the fritz.



Hang from the ceiling and fire down on the robot with Missiles. When the machine produces a ball, hit it or hover over it to avoid the blast.



FIFTH OBJECTIVE Proceed to the Navigation Room.

11 TRICKY TANK

The debris that the security robot left behind will give you something to climb onto so you can investigate a hidden section. Climb up, then move to the left. When you reach an industrial area with a large assembly hanging from its ceiling, detonate a Bomb under the object to make a pole rise from the ground. Hop up from the pole and plant Bombs at the peak of your jump. Destroy two blocks above you to expose an Energy Tank.

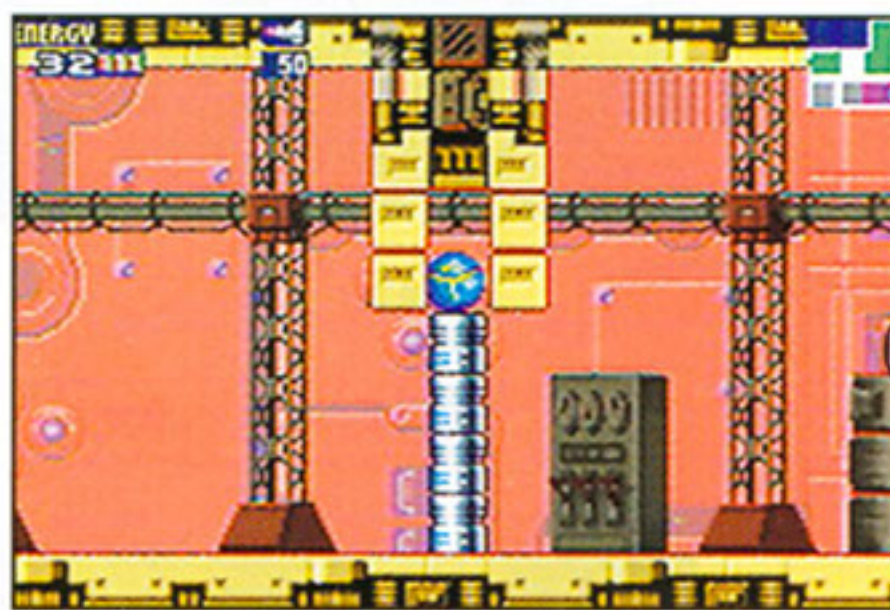

Detonate a Bomb on the floor to make a pole rise up and lift you to the hanging assembly.

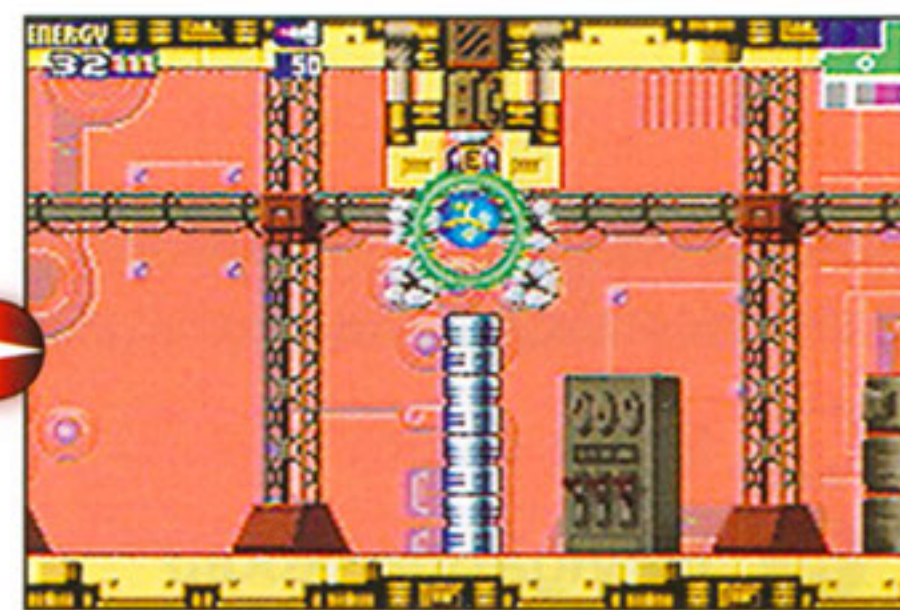

Jump in Morph Ball form and plant Bombs at the peak. You'll eventually expose an Energy Tank.

12 MORE MISSILES

Before you return to the Navigation Room for more instructions from the computer, you should investigate the area for extra items. If you drop to the bottom of the long, vertical corridor then move to the right, you'll find a room filled with spiked creatures. Clear away the enemies, then jump up onto the large object in the middle of the room. Set Bombs on the top to expose a Missile Tank. Roll and collect.

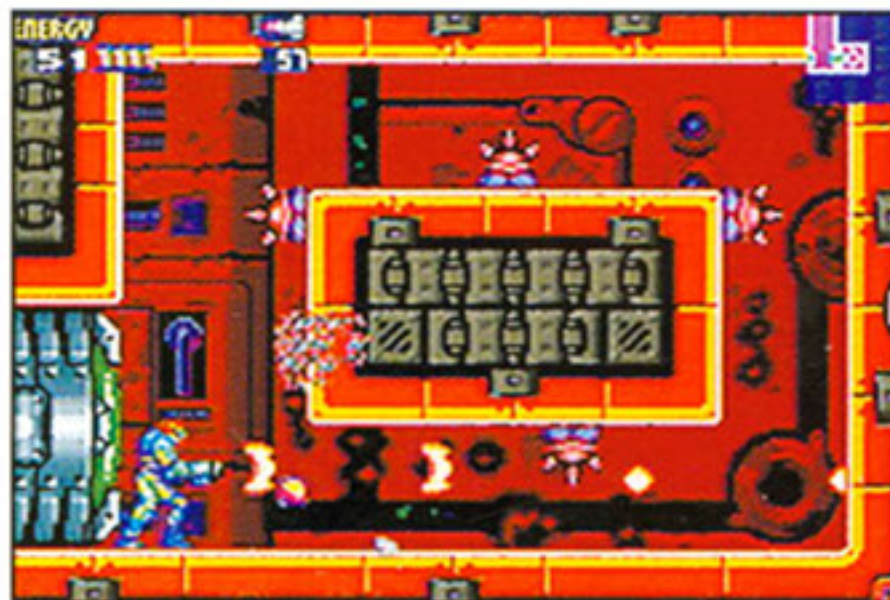

Drop into the lower-right section of the sector and defeat a pack of spiked enemies.

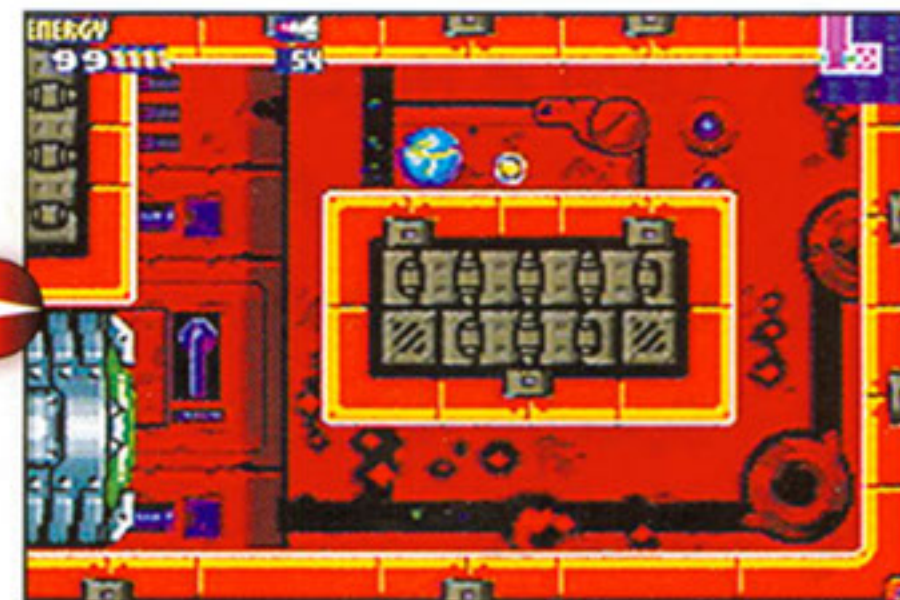

Jump onto the object that occupies much of the room and blast into it for a prize.

SECTOR 6

NOC

On your way to Sector 6, you'll get a glimpse of a mysterious transmission. A conspiracy is brewing. As you advance, you'll learn more. Next step: download the Varia Suit data.

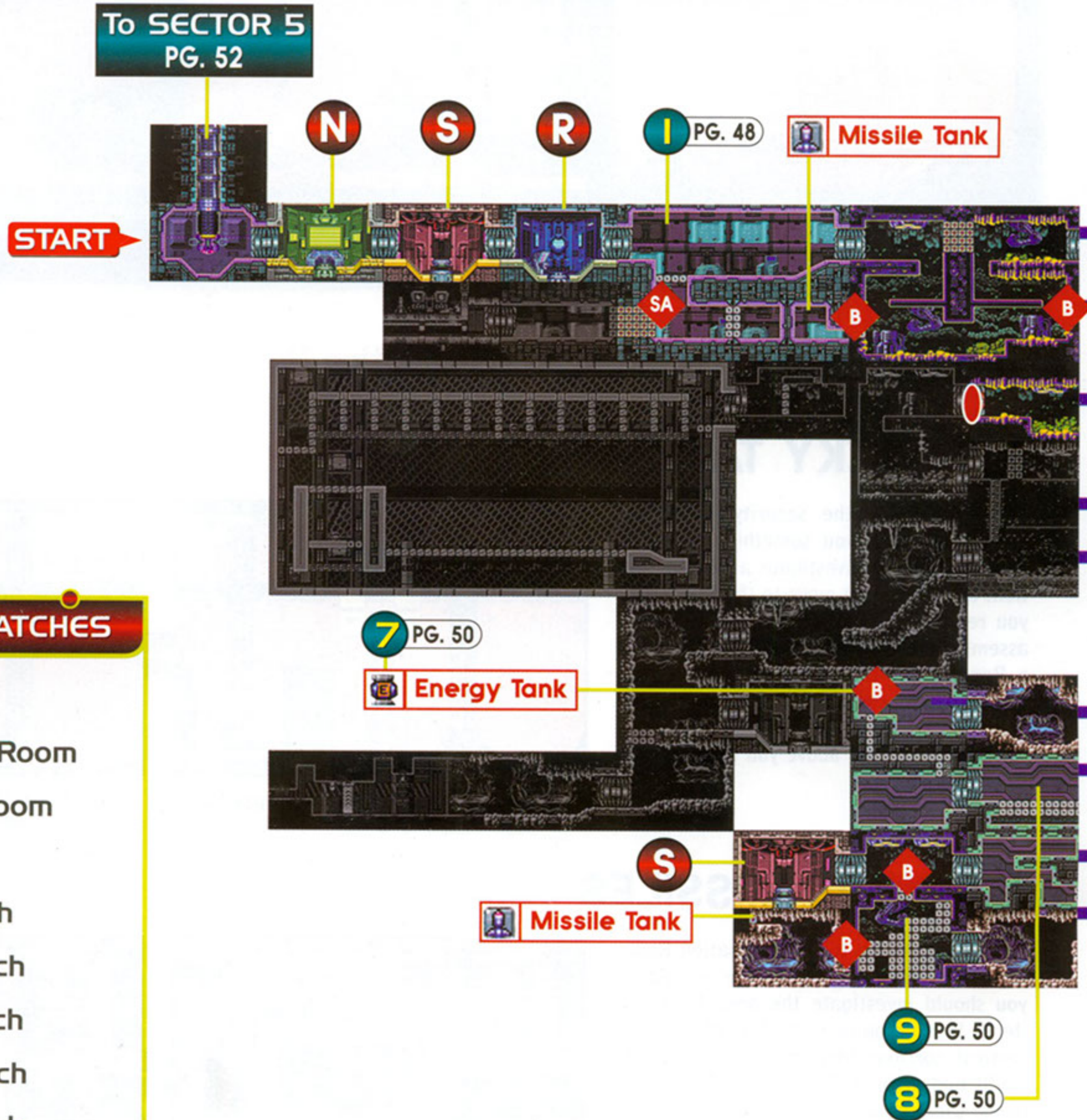
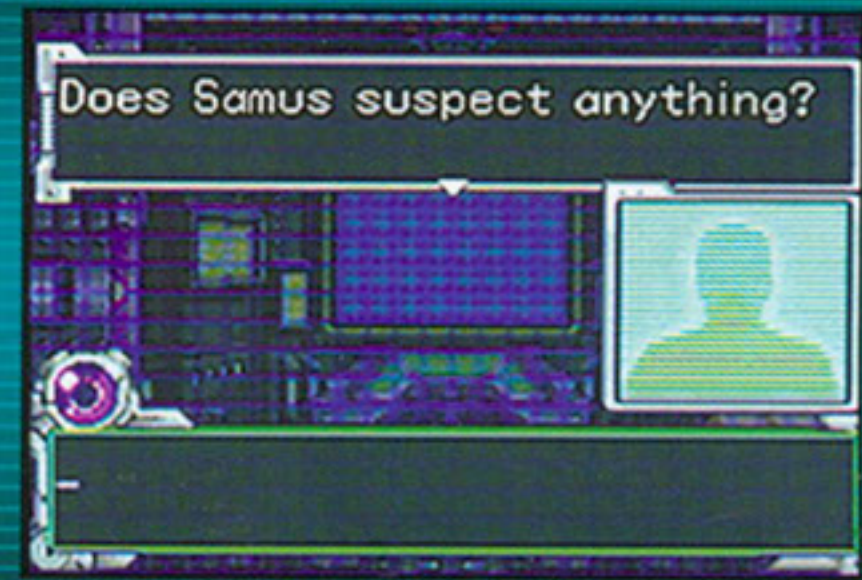

ROOMS AND HATCHES

- S** Save Room
- N** Navigation Room
- R** Recharge Room
- D** Data Room
- Level 1 Hatch
- Level 2 Hatch
- Level 3 Hatch
- Level 4 Hatch
- Special Hatch
- Shutter

BLOCKS

- B** Bomb Block
- PB** Power Bomb Block
- M** Missile Block
- SB** Boost Block
- SA** Screw Attack Block

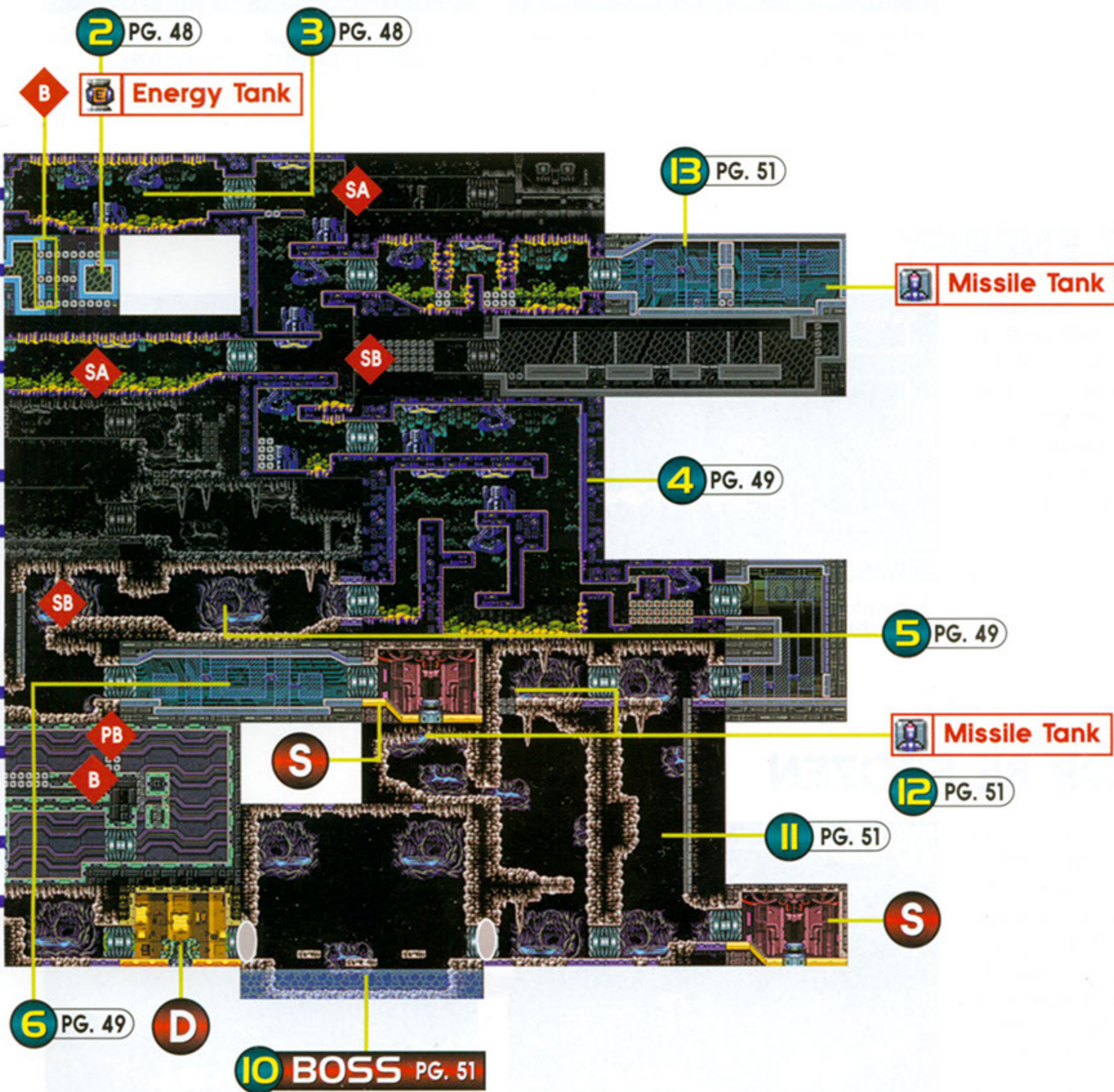

FIRST OBJECTIVE Download the Varia Suit data. Avoid contact with blue X parasites.

1 COMMON COLD

You will not be able to withstand extreme temperatures without the Varia Suit. If you absorb the ice blue X parasites in Sector 6 before you collect the suit data, you'll lose energy rather than regain it. Hit the freezing creatures with your Beam to stun them, and move on before they come back to life. If you're running low on energy, defeat the creatures that have been consumed by parasites and collect the yellow parasites that pop out of them.

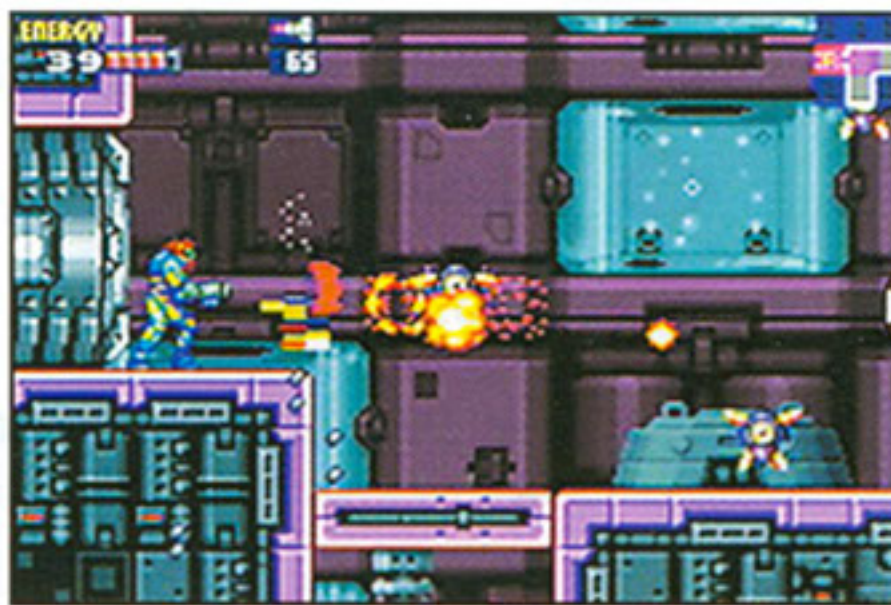

Defeat the clouds of parasite-inhabited creatures that occupy some Sector 6 areas.



Collect the yellow parasites that the creatures leave behind, but avoid the stray blue ones.

2 ACQUIRE ENERGY

Before you encounter any of the blue parasites, you'll have a chance to add depth to your energy reserves. Climb down into the first nocturnal area. When you're on your way up the other side, bomb a section of the wall to discover a narrow passage to a room that holds an Energy Tank. Use your Jumpball and Bomb abilities to approach the Energy Tank from above.



Jump up in Morph Ball form and blast a hole into the wall in the first nocturnal area.

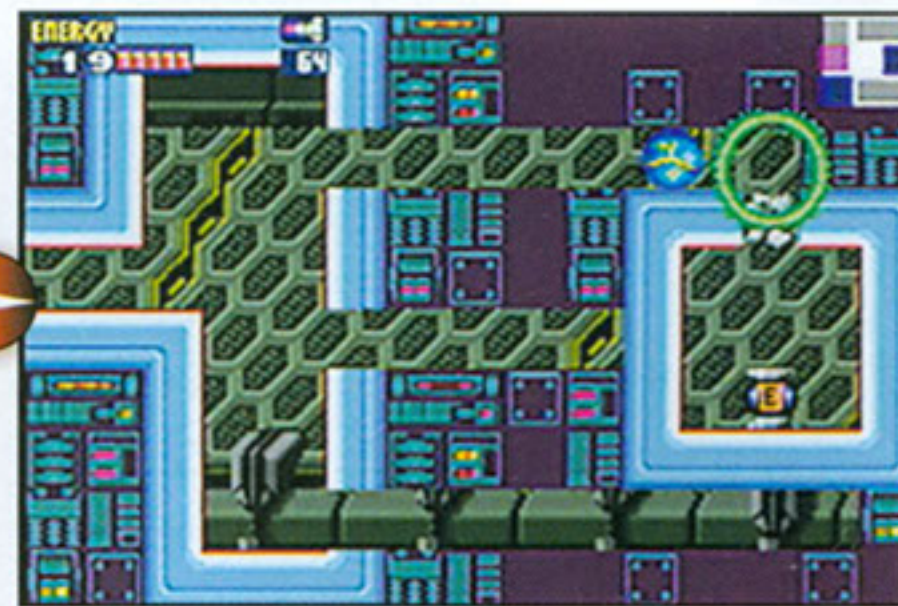

Hop up and to the right and bomb the wall for a passage to the Energy Tank.

3 FREEZE OR BE FROZEN

You've heard about the blue X parasites. In the small area that links two large nocturnal sections, you'll actually see one for the first time. Press the L Button to aim diagonally upward and fire your Beam as you approach the organism. One Beam shot will stun the parasite for four or five seconds. If you absorb the parasite, you'll lose about 70 units of energy. There are many more X parasites up ahead. You'll have to be very careful and stun them all to survive.



Aim your Beam into the air and stun the blue parasite as soon as you have a clean shot.



You'll have a few seconds to make your escape while the icy organism is frozen.

4 THE LONG, COLD WAR

The sections leading to the Save Room below are loaded with scads of blue parasites. You must freeze them with your Beam or they will catch up with you and sap some of your energy. The long, vertical sections have ladders, but there's no need to grab

onto them. It's faster to fall. There are two offshoots to the main passage—to the right and left. Don't bother exploring those areas. They're filled with blue parasites. Once you have the Varia Suit, you'll be able to enter those areas and absorb the blue parasites

while regaining energy instead of losing it. If some of the parasites hit you while you're on your way to the Save Room, don't worry. You'll soon have an opportunity to collect energy-replenishing yellow parasites.



Be careful when you blast away at blocks. Some of them contain captive blue parasites.



By firing through a wall, you'll gain access to a path that leads to the next area.

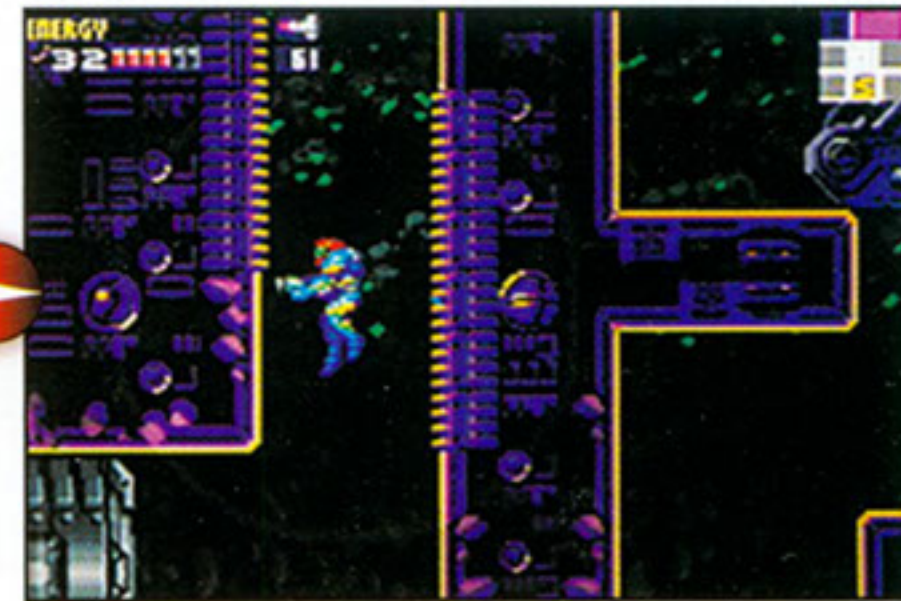

Don't deal with the ladders. You'll save time by dropping through the long, vertical sections.

5 BLAST AND BOOST

As soon as you enter the natural rock corridor above the Save Room, run to the left, firing up at the area's blue parasites as you go. There is a Boost Block barrier at the end of the corridor. If your Speed Booster has not engaged by the time you reach it, you'll have to retreat to the right and try to get a better running start. By then, the parasites that you stunned will be back on the prowl, waiting to pounce and sap your energy.



Enter the corridor running and fire diagonally up and to the left. Your shots will freeze the parasites.



If your Speed Booster has engaged by the time you reach the left end, you'll blaze through the wall.

6 BATTLE REWARDS

The chamber to the left of the Save Room is full of flying fiends. You'll be able to beat them easily with a rapid Beam barrage. Collect the yellow parasites that emerge from the enemies, then move on to the Save Room. The enemies will reappear when you return. Clear them away again, collect the yellow parasites, then leave and enter again if you want to fill more of your energy reserves. Every trip through the room should net you 90 units.

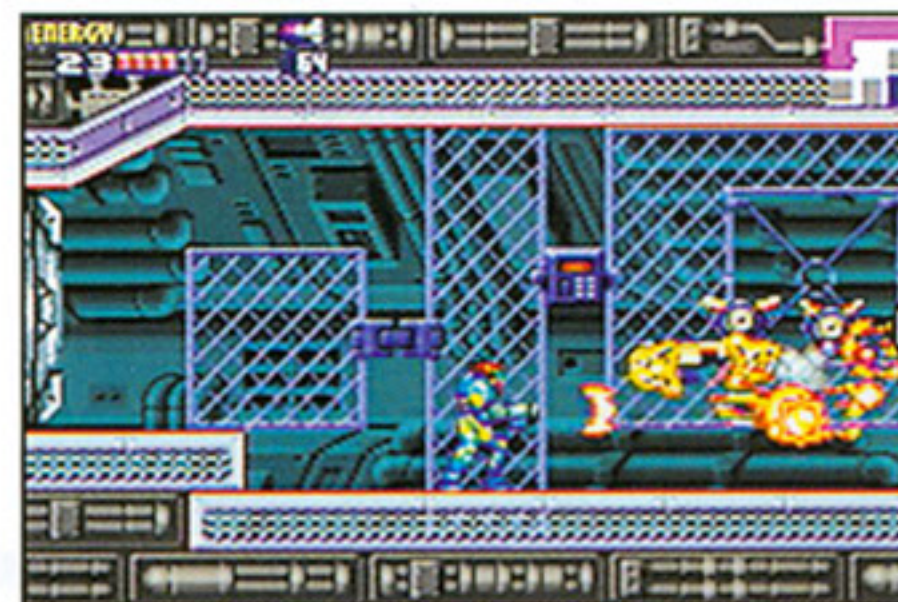

Fire on the flying creatures and collect all of the yellow parasites after you've won the battle.



Finally, you can save your game data. It's been a difficult journey, but you have endured.

7 HIDDEN HOLE

Leave the Save Room area, then run and roll to the left and make your way to the room that contains an Energy Tank. You'll be in good shape after you collect your second tank in the sector. There are no obvious routes to the next area, so you'll have to find a hidden passage. Plant Bombs on the platform where you found the tank. You'll start a Bomb Block chain reaction that will clear a passage to the room below.

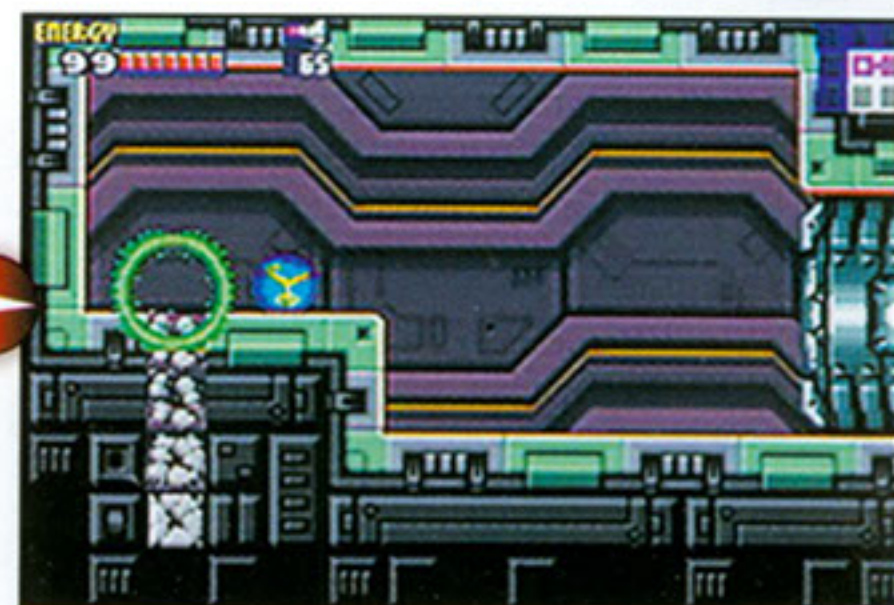

8 SA-X AGAIN

Your path leads to a long, horizontal corridor with a narrow passage under the floor that runs the length of the area. When you reach the barrier on the right end, roll into a Morph Ball and plant a Bomb in the corner. You'll destroy a Bomb Block in the floor and expose

two Power Bomb Blocks in the barrier. Drop into the tight tunnel and roll to the left. When you return to the left end of the corridor, the SA-X will appear, but it won't see you. Roll right while the Samus impersonator walks along the hall and uses a Power Bomb to blast

through the barrier that you were not able to destroy. Stay hidden while the creature walks to the right and, eventually, moves on to the next room. You've seen the SA-X's powers firsthand. You don't want to confront the creature until you are better equipped.

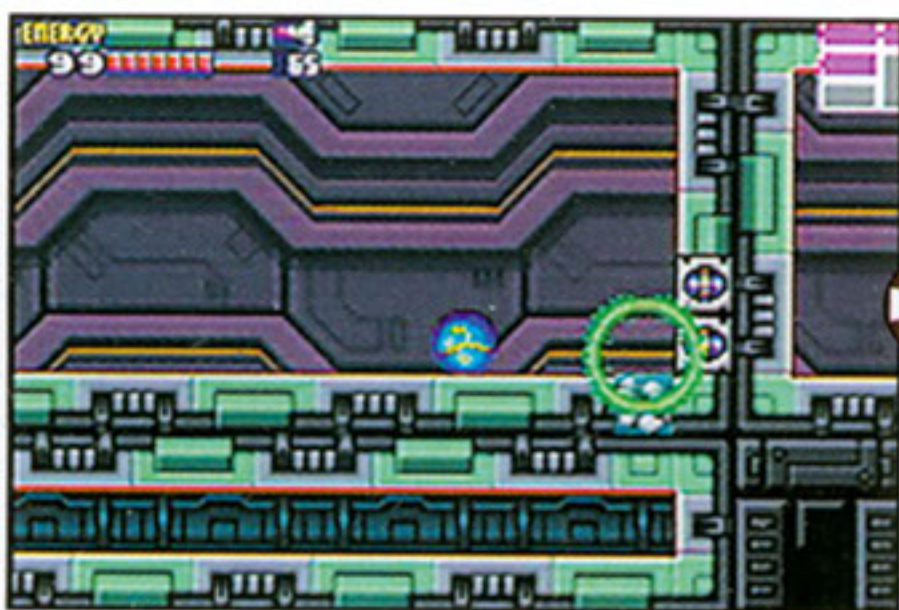

Run to the right side of the corridor and plant a Bomb to destroy a section of the floor.



When the SA-X appears, follow it to the right end of the corridor and watch it destroy the barrier.

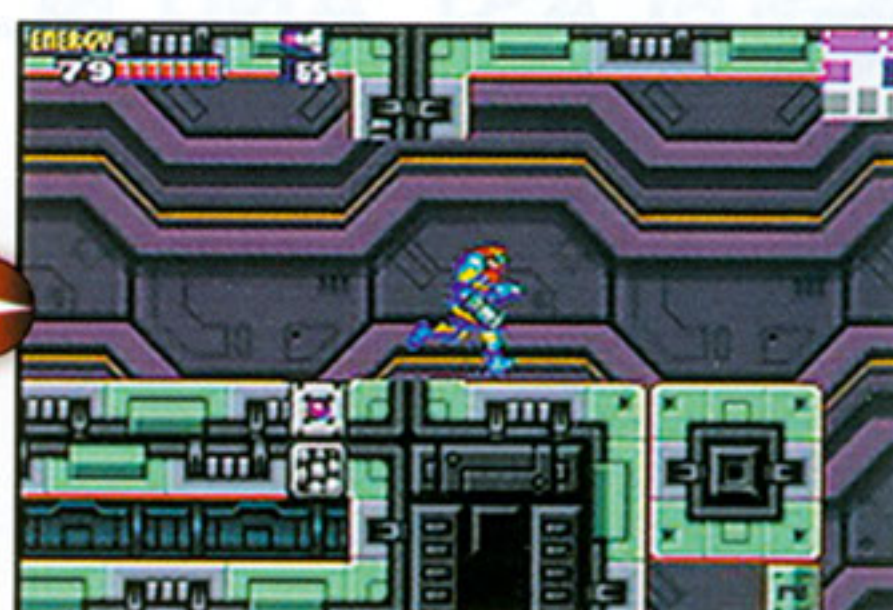

Hide for a few moments, then follow in the SA-X's footsteps to the area beyond the barrier.

9 BLUE PARASITE SURPRISE

Save your progress before you bomb into the room that has dark, organic-looking blocks. As you make your way down, destroy only the three sets of blocks that Samus is destroying in the pictures below. The other

blocks contain blue parasites. If you free them, they will attack. You can try to freeze freed parasites with your Beam, but you probably won't be able to leave the area before they come back to life. If you destroy

only part of a block that contains a parasite, don't fret. A parasite can't escape unless you destroy its entire block. After you leave the room, feast on small creatures and yellow parasites.



SECOND OBJECTIVE Destroy the X parasite that has acquired the Varia Suit data.

10 BOSS BATTLE

When you reach the Data Room, you'll watch one of the creatures destroy the computer uplink. Follow it to the next room and go up against a large, round

monster. Hit the creature with Charge Beam shots to both damage it and make it bounce away from you. Avoid it while it's flashing, then hit it again when it's solid.

After you destroy it, a Core-X will pop out. Hit the shielded parasite with Missiles then absorb the stolen Varia Suit data.



The creature that holds the Varia Suit data resembles a giant, deadly beach ball.



Jump from platform to platform as you avoid contact with the beast and hit it with your Charge Beam when you have a clean shot.



THIRD OBJECTIVE Proceed to the Navigation Room.

11 BLUE RECOVERY

The Varia Suit allows you to withstand extreme temperatures, which means that the icy blue X parasites are an ex-problem. Collect them to replenish your lost energy.



13 TANK BATTLE

As you explore an offshoot passage that was too dangerous before you had the suit upgrade, you'll encounter a fake Missile Tank. Destroy it with Missiles, then bomb your way to the left and collect a real tank.

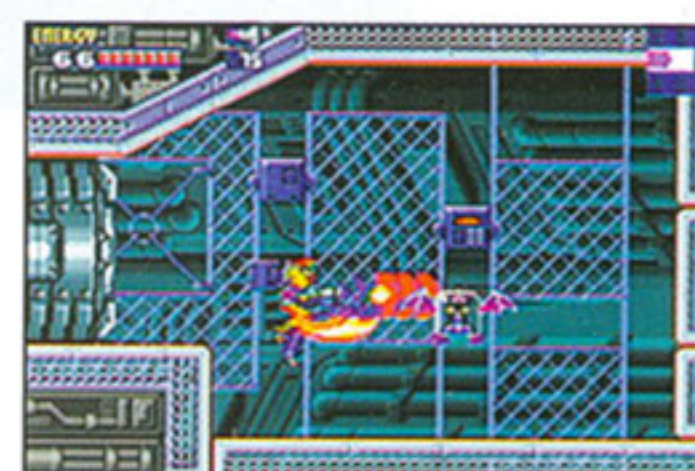

12 TAKE TWO TANKS

After you climb up a long, vertical section and collect several blue parasites, go left to a room that contains a Missile Tank. The ground near and under the tank will break away if you stand on it. Stop after you pass

the hanging rock, then jump over to the Missile Tank. You'll collect the prize and fall through the floor. Press and hold Left on the Control Pad as you drop to grab a ledge, then pull yourself up and roll into a small room

that is populated with two wall-crawling enemies. Destroy the enemies, collect their parasites and fire Beams at the ceiling. You'll expose another Missile Tank.



SECTOR 5

ARC

Samus's molecular makeup is too unstable to absorb her old Ice Beam, but she can use the new Ice Missiles. You'll find the data behind a Level 3 hatch.



- BLOCKS**
- B** Bomb Block
 - PB** Power Bomb Block
 - M** Missile Block
 - SB** Boost Block
 - SA** Screw Attack Block

- ROOMS AND HATCHES**
- S** Save Room
 - N** Navigation Room
 - R** Recharge Room
 - D** Data Room
 - Level 1 Hatch
 - Level 2 Hatch
 - Level 3 Hatch
 - Level 4 Hatch
 - Special Hatch
 - Shutter

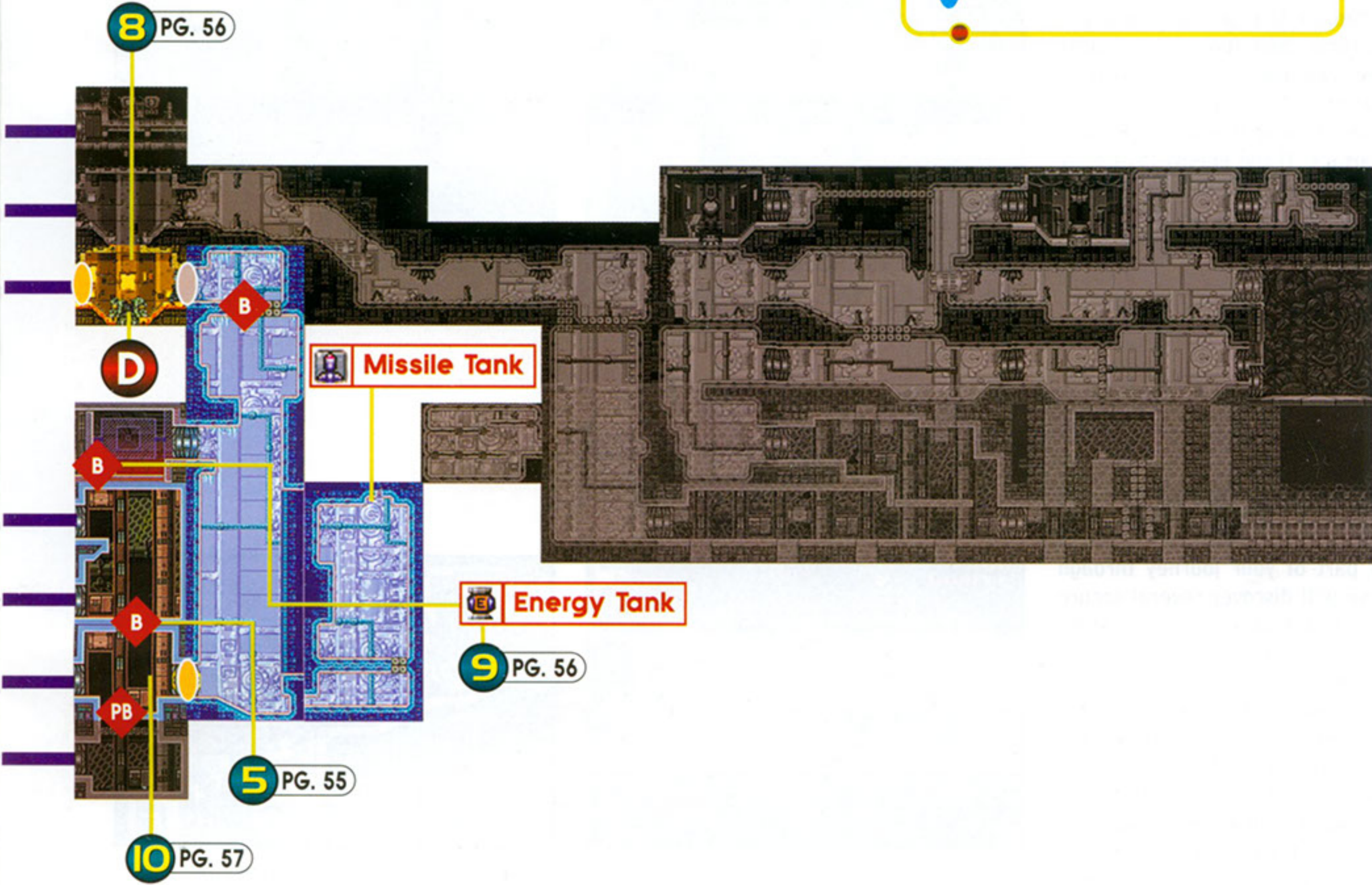

FIRST OBJECTIVE Locate the Security Room and activate Level 3 hatches.

1 SECURITY WORK-AROUND

Level 3 hatches secure Sector 5. You'll find two of them at the bottom of the sector's first vertical section. The only way around them is by way of a secret tunnel. Stop at the top of the ladder on the left wall and clear away any stray enemies in the area. Then fire a Missile directly to the right. You'll break two blocks and open a narrow passage to the next area. Jump over the gap, hang and roll.

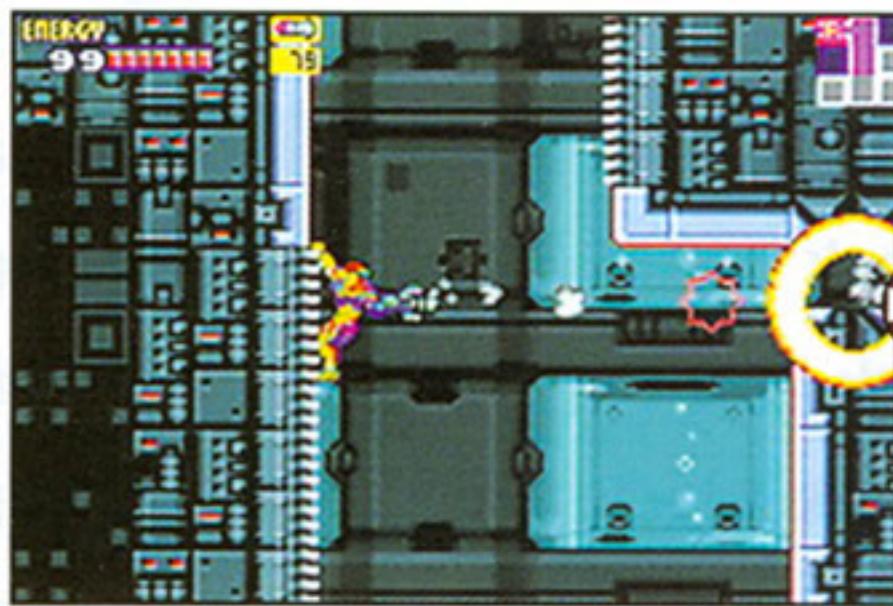

Fire to the right (from the top of the ladder) and destroy a Missile Block barrier.

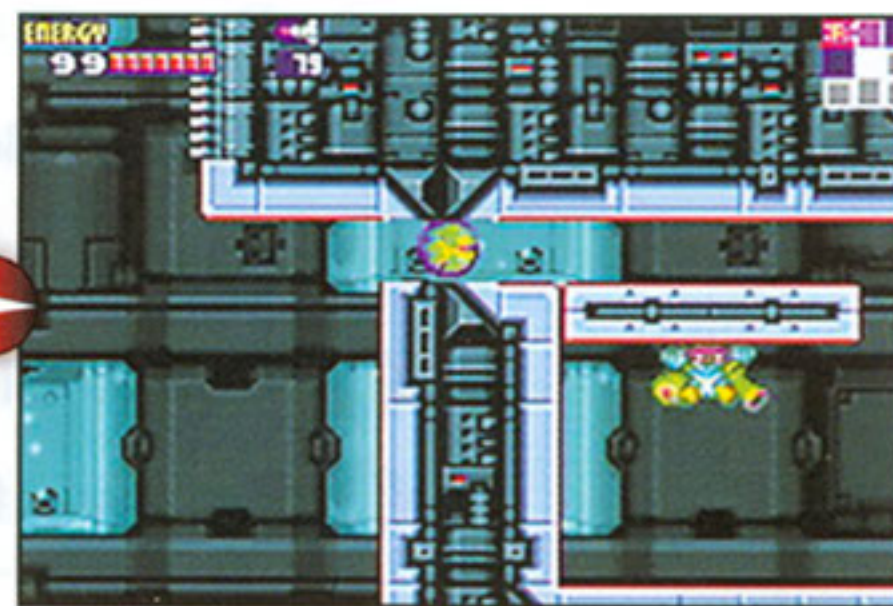

There's no underestimating the power of the Morph Ball. Roll on through to the next area.

2 FLAT FOES

The arctic sector is full of flat, blue creatures. They launch straight up when you close in on them, and they fire straight down as they float back to the ground. If you approach one of the creatures on flat ground, you can destroy it with a crouching Beam blast attack. If the enemy is already in the air before you can get off a clean shot, aim diagonally upward and hit it from a safe distance.

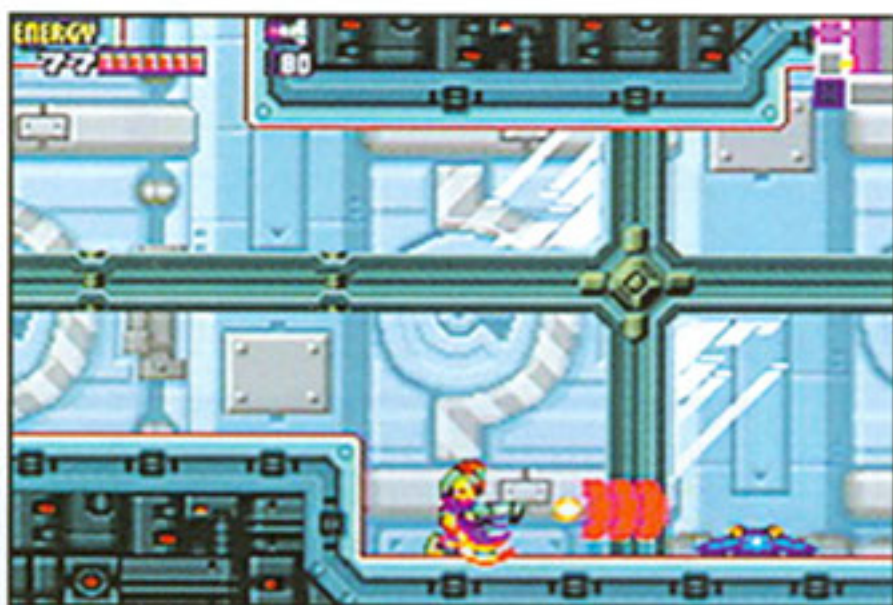

Crouch and fire on the flat foe while it's still on the ground.



If the enemy launches, hit it with diagonal Beam fire.

3 FAST BREAK

In the early part of your journey through the sector, you will discover several secure hatches and locked shutters. When you work your way around and down the winding passage in the large, refrigerated area, you'll discover a narrow floor section that is made up of Boost Blocks. Run left into the hallway that leads to a blocked Save Room, and clear away all of the enemies in the area. Turn around when you reach the shutter, then run to the right and don't stop. Your booster will engage, and you'll break through the blocks.



You'll need a runway. Defeat all of the enemies in the hall leading to the closed shutter.

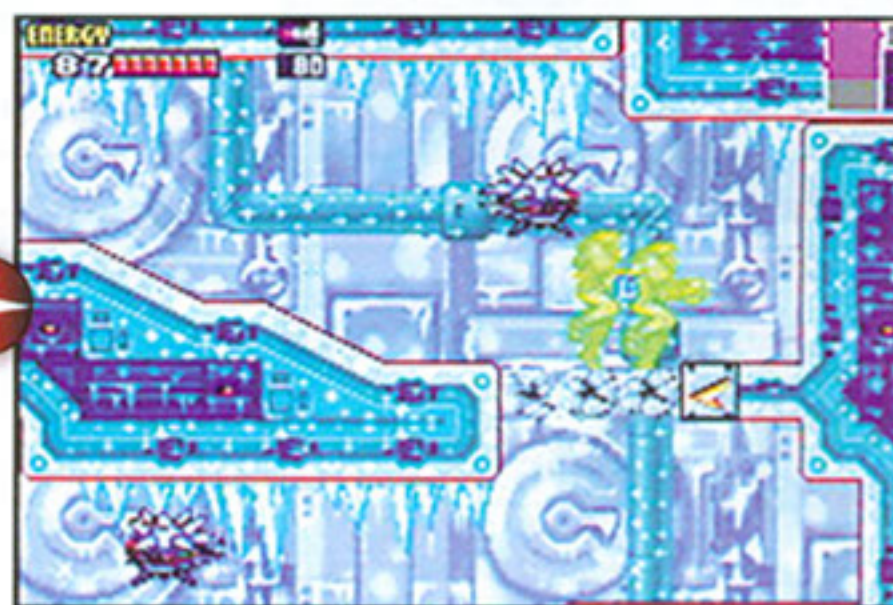

Go to the right, blast through the Level 0 hatch and hit the blocks running.

4 FOUR AGAINST ONE

When you reach the one-screen-wide room in the lower-right section of the sector, you'll see four prickly, flying creatures on the other side of a thin wall. Plant a Bomb to start a chain reaction that will destroy the wall, then go up against all four creatures at once. You may not be able to make it out of the battle unscathed, but you will be able to hold your own with rapid Beam fire and evasive maneuvers.

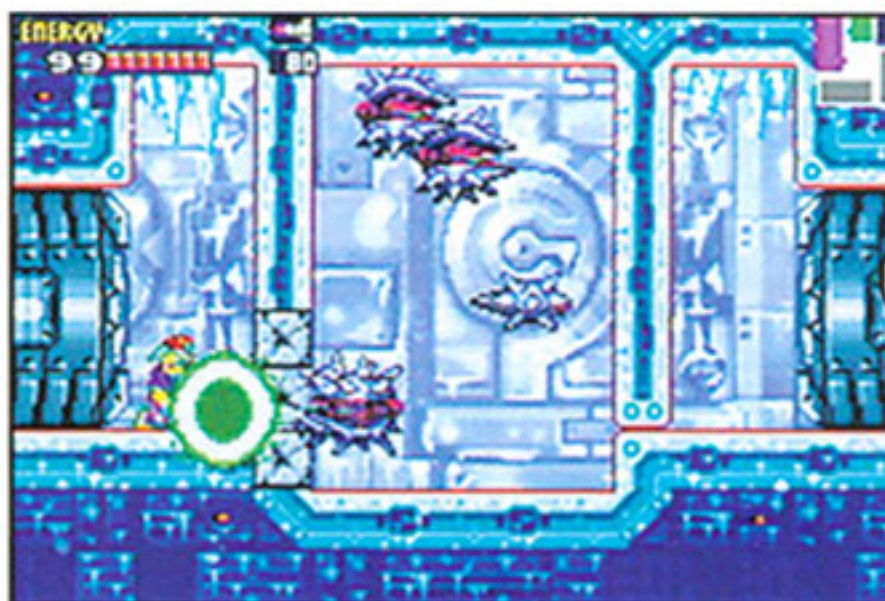

Plant a Bomb, then straighten out, charge your Beam and get ready for a fight.



Attack the flying beasts with rapid fire and collect the lingering parasites that they leave behind.

5 SECRET SECTION

The computer's map will show that you have reached the lower-right corner of the sector and that the only way to go is through the passage to the left. You'll discover that the passage has a Boost Block barricade but not enough running room to charge up the Speed Booster. Return to the corner room and place Bombs in the middle of the platform. You'll uncover a path to a new area.

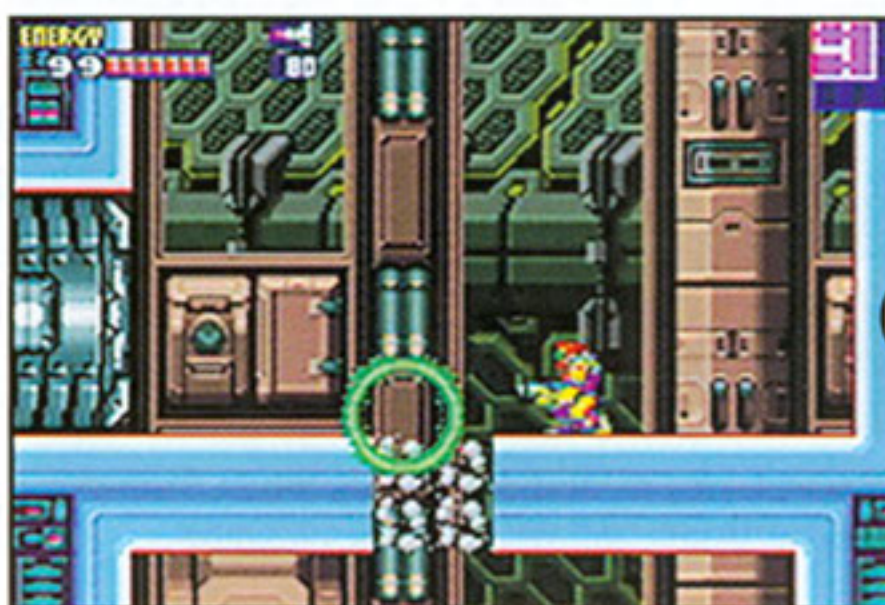

A well-placed Bomb in the corner room will give you a breakthrough to another area.



The curious, round creatures in the area will prove to be useful once you have the Ice Missiles.

6 ADVENTURE POTENTIAL

You've seen a lot of yellow hatches over the course of your journey through Sector 5. When you reach the Security Room and disable Security Level 3, you'll unlock all of those hatches at once. The move will give you much more freedom to explore the area and access to the Data Room, where you'll download the Ice Missile information. It will also let the X parasites spread. They're taking over, one sector at a time. You've got to stop them.



The Data Room in the unmapped section of Sector 5 unlocks all Level 3 hatches in the research station.



The yellow hatch in the room will begin to flash. Hit it with a Beam shot and move on to the left.

SECOND OBJECTIVE Proceed to the Data Room.

7 ICY ASCENT

Your climb to the top of the unmapped section could be deceptively difficult. The crab-like creatures that populate the area fire strong shots in two directions, and when you destroy them, they regenerate very quickly. Hit them, then collect their parasites in a hurry. Also, beware of the ice blocks. Some of them will crumble under your weight and send you tumbling down.

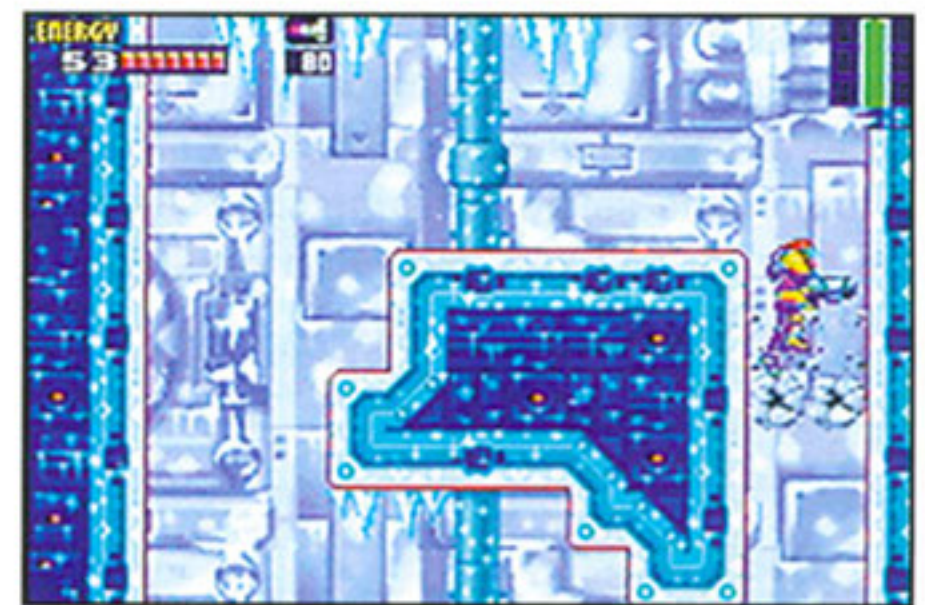
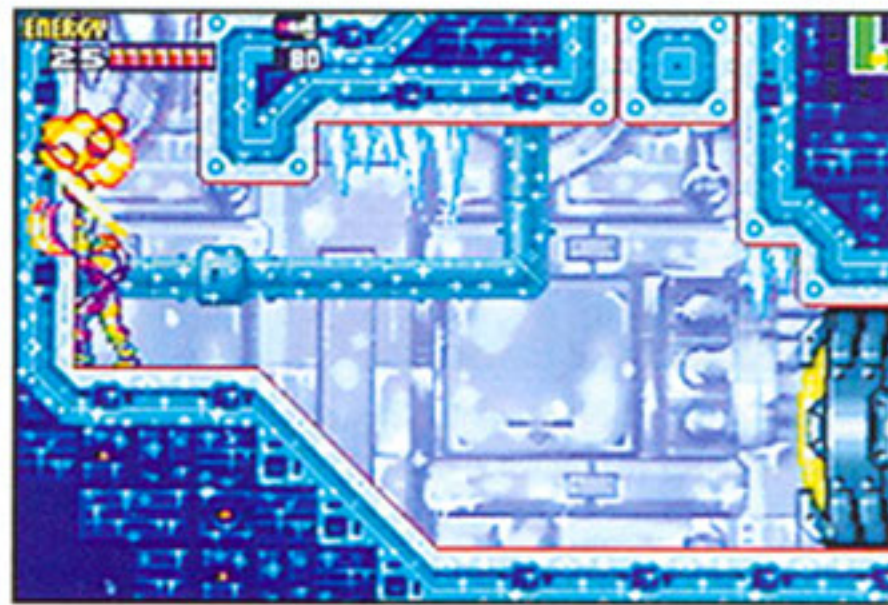

8 DOWNLOAD DATA

After your ascent, you'll return to familiar territory, where you can find out what's behind the yellow hatches. Make your way to the Data Room and download the Ice Missile upgrade. Your Missiles will still have three times the power of standard Missiles, plus they will freeze the enemies that they don't destroy. You'll find the freeze factor to be very useful as you explore.



You've finally made it to the Data Room. Step into the booth and connect with the computer.



The data download will add an icy charge to your Missiles, which can freeze some targets.

THIRD OBJECTIVE Proceed to the Navigation Room.

9 ACQUIRE MORE ENERGY

Your orders are to return to the Navigation Room, but a one-way shutter won't let you leave the way you came in. You'll have to find an alternate route. Use Bombs to blast into an unmapped area, and grab onto a ladder

on the right wall as you fall. Climb up the ladder to the level of a back-and-forth floating enemy, and hit it with a Missile when it's in the middle of its pattern. The creature will freeze. Hop onto it, then jump

up and to the left to reach a ledge. The room to the left holds a false Energy Tank that will attack. Defeat it, then use Bombs to find a real tank in the wall.

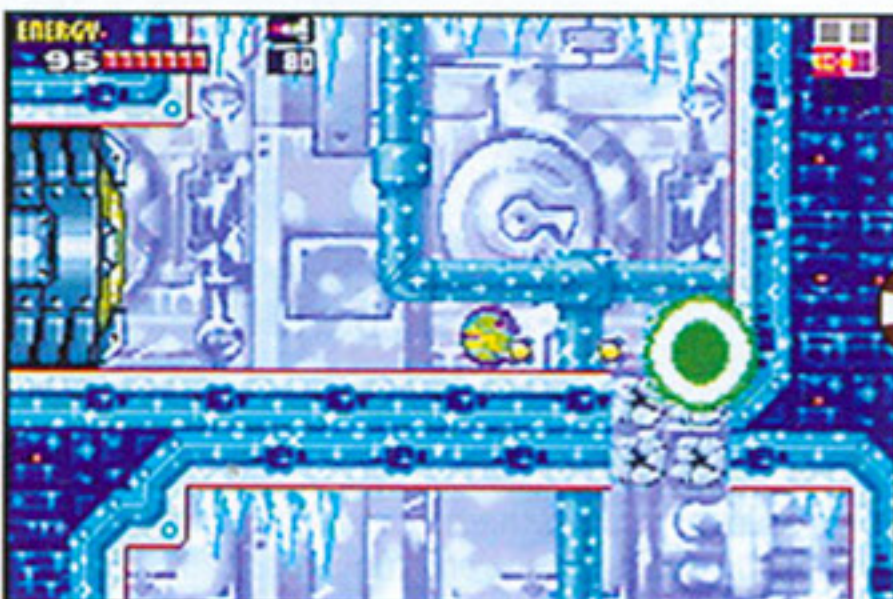

Detonate Bombs to discover a passage to an area that connects to the sector's lower-right section.

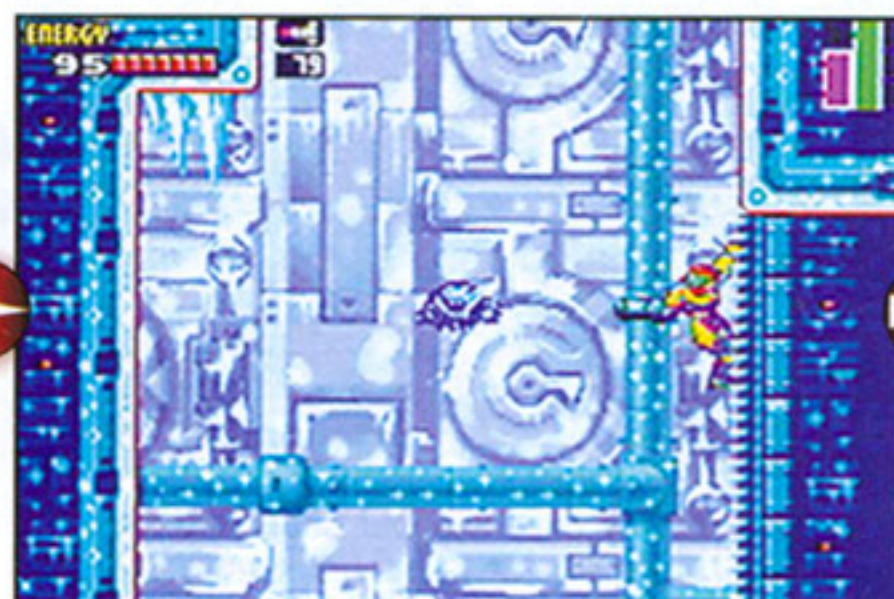

Grab onto the ladder on the right wall and use Missiles to freeze an enemy in midair.

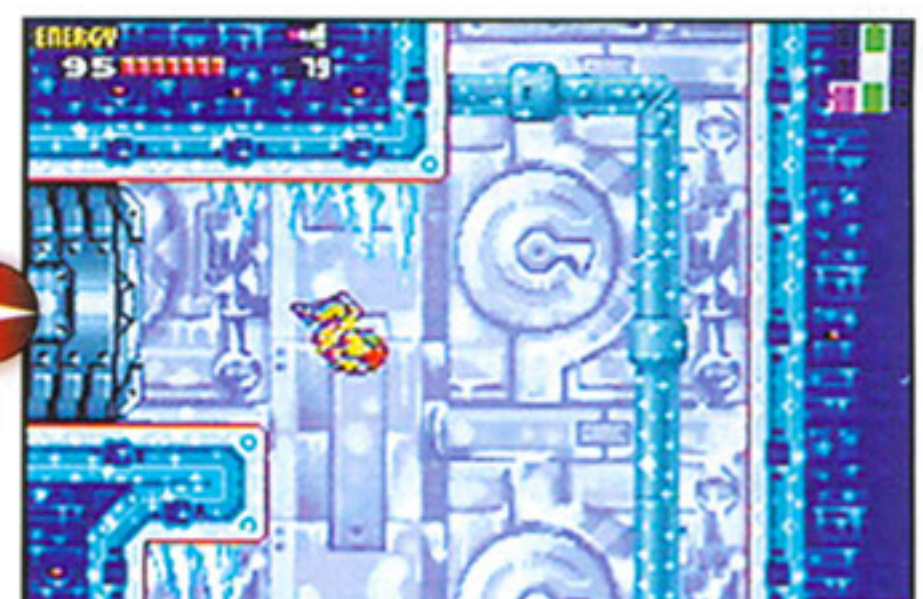

Hop onto the frozen creature, then jump to the left to reach a hatch that leads to an Energy Tank.

10 FROZEN GROWTH

The round plants in the sector turn into tall, dangerous organic walls when they absorb X parasites. A parasite will enter the plant in the lower-right section of the sector as soon as you enter the area. You can jump over the plant, but in the interest of exploration, you should freeze it with a Missile and use it as a platform. Jump onto the frozen growth and fire up at the ceiling. You'll open a hole that will give you access to the area above.



Aim an Ice Missile at the organic wall to turn it into an icy platform.



Hop onto the frozen plant and blow open a hole in the ceiling with your Beam.

11 ICE ON THE RUNWAY

You've been there before—the area with the Boost Blocks but no room to run. What you need is a runway. Stop near the plant and target the crab creature that crawls on the ceiling. After you destroy the creature

once, it will quickly regenerate. Beat it again, then drop down to the plant's level. The crab's parasite will occupy the plant and make it grow. Freeze the plant with an Ice Missile then jump up to the platform.

Start on the right side and run to the left, over the frozen plant. Open the hatch on the run and keep going. Your Speed Booster will charge, and you'll blast through the Boost Block barrier.



Blast the enemy on the ceiling. It will regenerate first then drop to occupy the plant.



Freeze the growth, then jump up onto the high platform and run to the left.



When the Speed Booster charges, you'll fly through the area's Boost Blocks.

12 FREEZE AND RUN

As you leave the sector, you'll discover that your newfound Missiles are very useful for dealing with all types of enemies. When the flat, blue fiends fly up and fire down, you can freeze them with Missiles then run under them or use them as platforms. Experiment with different ways to deal with the enemies and prepare for a challenge. Before you reach the elevator, you'll discover that there is value to quick sector navigation.



13 POP UP POWER

One large creature and three small ones populate the room that connects vertical passages. After you deal with the big beast, morph into a ball, jump and bomb the upper-right corner to expose a Missile Tank. Straighten out, jump up and collect it.



SECTOR 3

PYR

There's no rest for the weary. Before you can even make it out of Sector 5, you'll learn about an emergency in Sector 3. You've got six minutes before the meltdown.

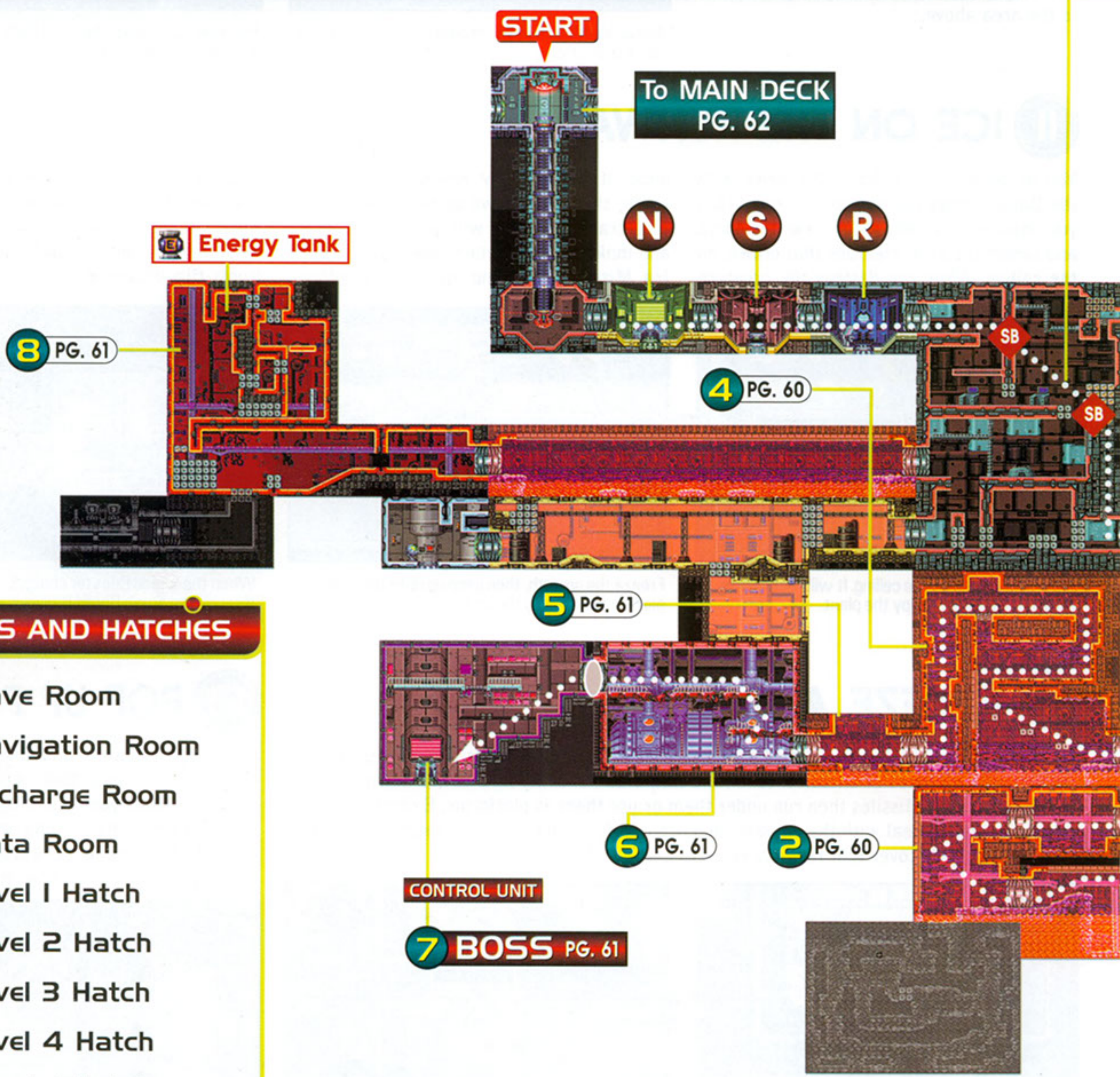
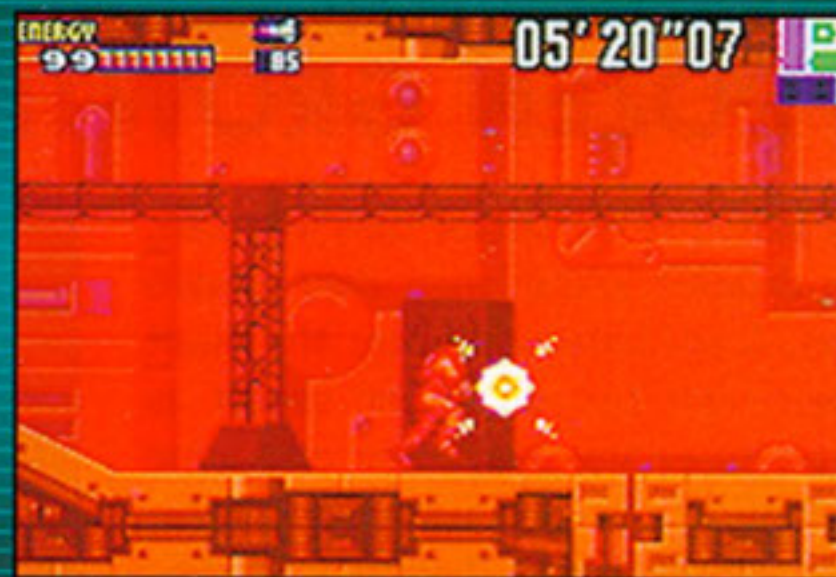

- ### ROOMS AND HATCHES
- S** Save Room
 - N** Navigation Room
 - R** Recharge Room
 - D** Data Room
 - Level 1 Hatch
 - Level 2 Hatch
 - Level 3 Hatch
 - Level 4 Hatch
 - Special Hatch
 - Shutter

SPEED TO A SHORTCUT

After you leave the Navigation Room, don't stop for anything else. Run through the Save Room and Recharge Room and charge up your Speed Booster. When you reach the next section, you'll fly through two Boost Block barriers.

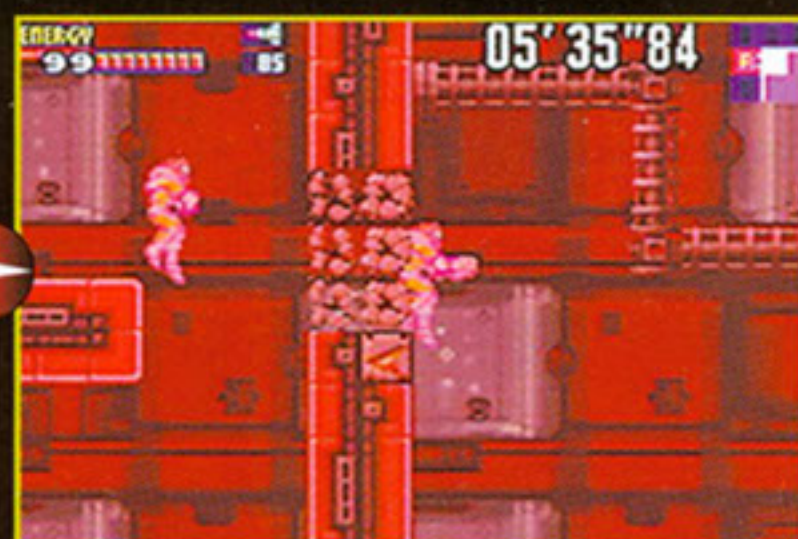

BLOCKS

- B** Bomb Block
- PB** Power Bomb Block
- M** Missile Block
- SB** Boost Block
- SA** Screw Attack Block

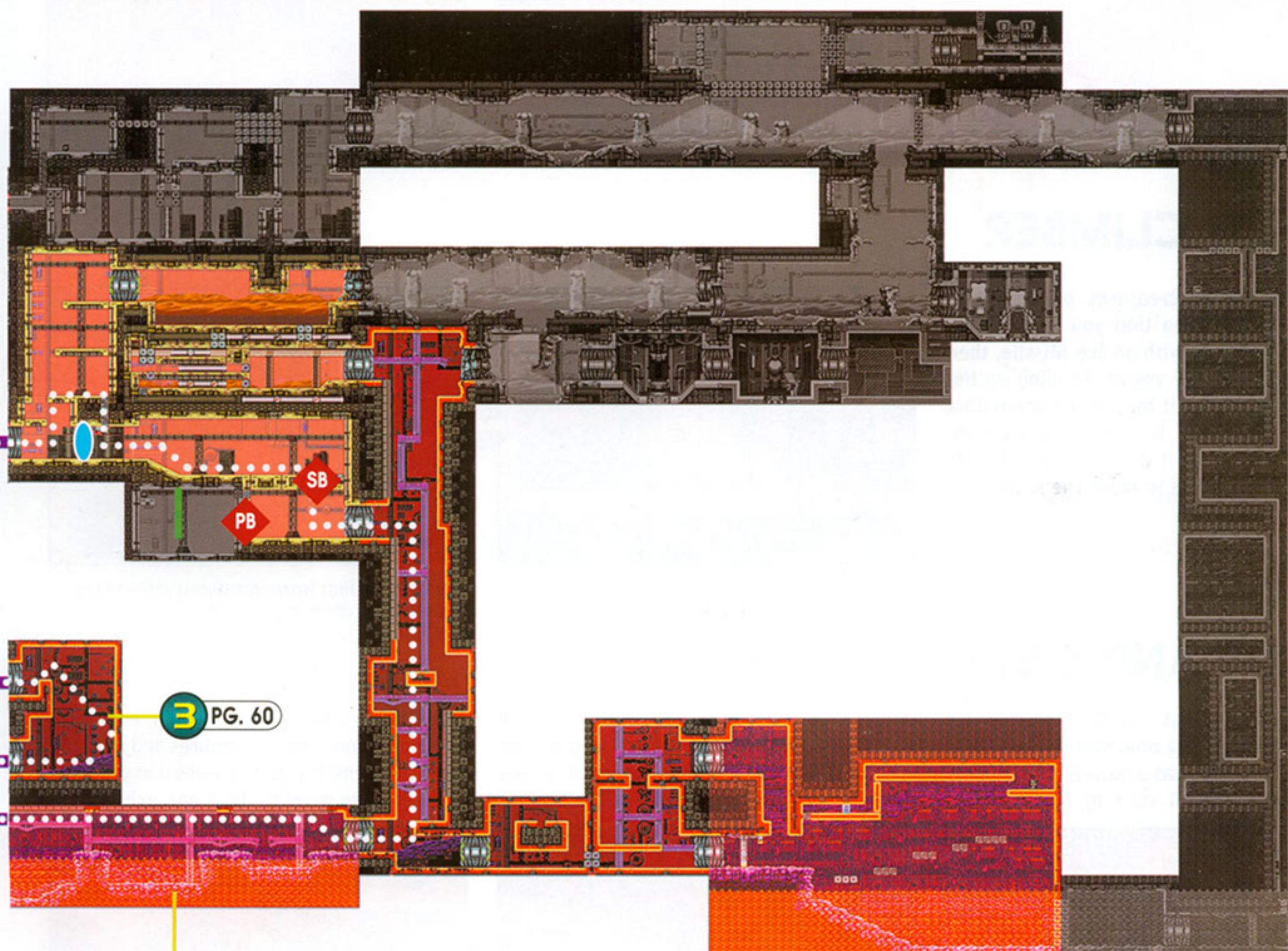

1 PG. 60

3 PG. 60

FIRST OBJECTIVE Race to the Control Unit.

1 OVER HEAT

The long hall at the bottom of the sector is flooded with lava. If you drop into the lava, you'll lose energy and waste time. Grab the horizontal ladder on the ceiling and climb to the left. Be sure to avoid the flames that rise up, and fire on the flying enemies.



2 STEP UP

The route to the control unit is circuitous. You'll make a zigzag pattern up the middle of the sector before you set a straight course to the left. After you survive the lava-filled room, you'll have to reach a high ledge. Hit the lower of two long-necked enemies with an Ice Missile, then use the frozen beast as a step up to the top passage. It'll be easy if the creature's neck is extended.



Blast the enemy on the ceiling. First it will regenerate. Then it will drop to occupy the plant.

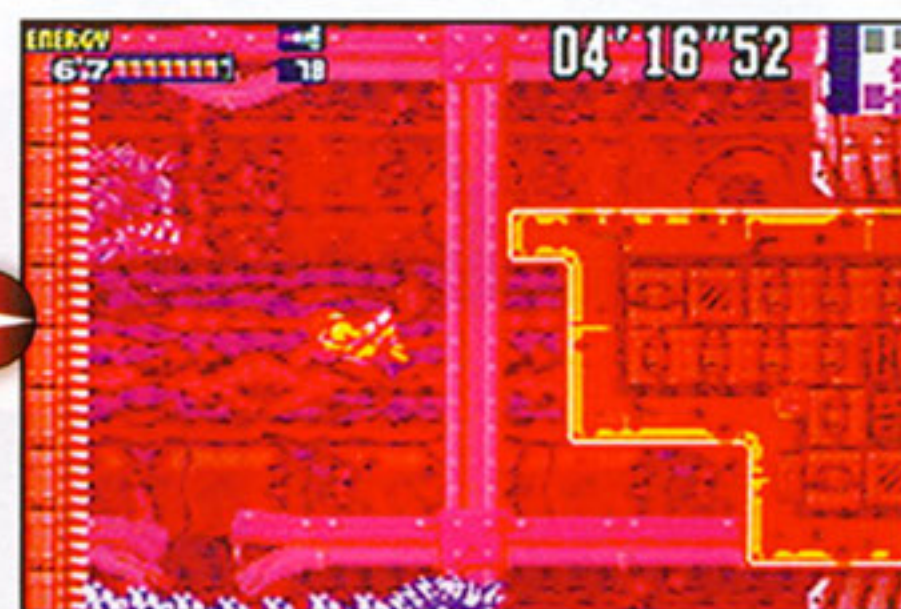

Freeze the growth, then jump up onto the high platform and run to the right.

3 ICE CLIMBER

Two long-necked creatures populate the second vertical area that you must climb. Hit the lower one with an Ice Missile, then jump onto it. While you're standing on the first frozen beast, hit the second one with a Missile blast. Don't fire on either creature while it's frozen or it will disappear. If that happens, you'll have to leave the room then reenter.



Fire an Ice Missile at the lower of two long-necked creatures to freeze it for a few moments.



Hop onto the first frozen creature and fire at the second one from your icy perch.

4 UP AND OVER

The last section that you must get through before you can take a relatively straight route to the control unit has a variety of creatures and obstacles. You'll start by hopping from

platform to platform over a lava pool. Then you'll deal with one of several long-necked creatures. Freeze it when its neck is not extended or defeat it outright with a few Ice

Missiles. As you continue, you'll encounter two more long-necked creatures and a break-away platform. Use Ice Missiles and your athletic ability to move to the area's exit.



Freeze the beast on the wall with an Ice Missile and use it as a step to the next ledge.



When you reach the higher ledge, be ready to fire on the fiery fiends.



As you work your way up and around the bend, freeze the enemy to keep it from extending.

5 HOT HOP

The small room that leads to the main boiler has some fiery enemies and a platform over lava, which will crumble under your feet if you step onto it. Defeat the enemies with your Beam, then jump over the lava gap.

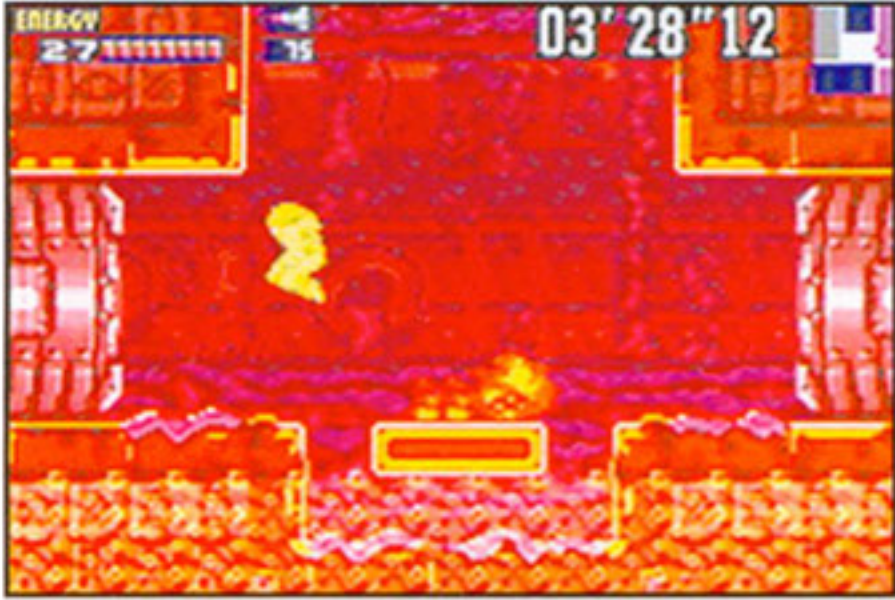

6 HEAT RISES

The hatch to the control room is near the top of the main boiler room. Jump up through a hole in the walkway and run to the left, making sure that you jump over all of the other holes. A giant eyeball protects the hatch. Wait for the eye to open, then hit it with a Missile when it shows its pupil. If it flashes white and yellow, get ready to jump over an energy blast. Once the eye is gone, collect a red parasite and enter the control room.

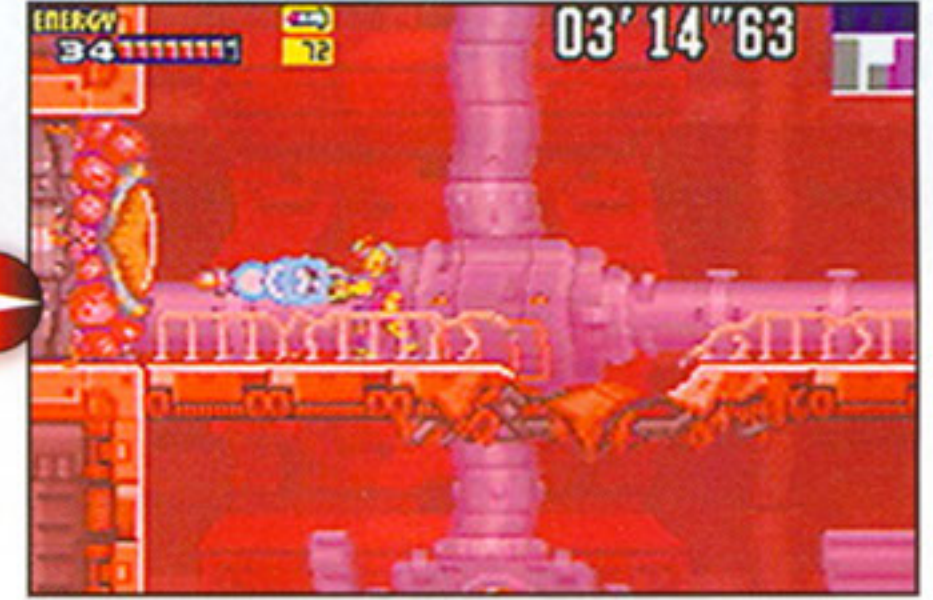
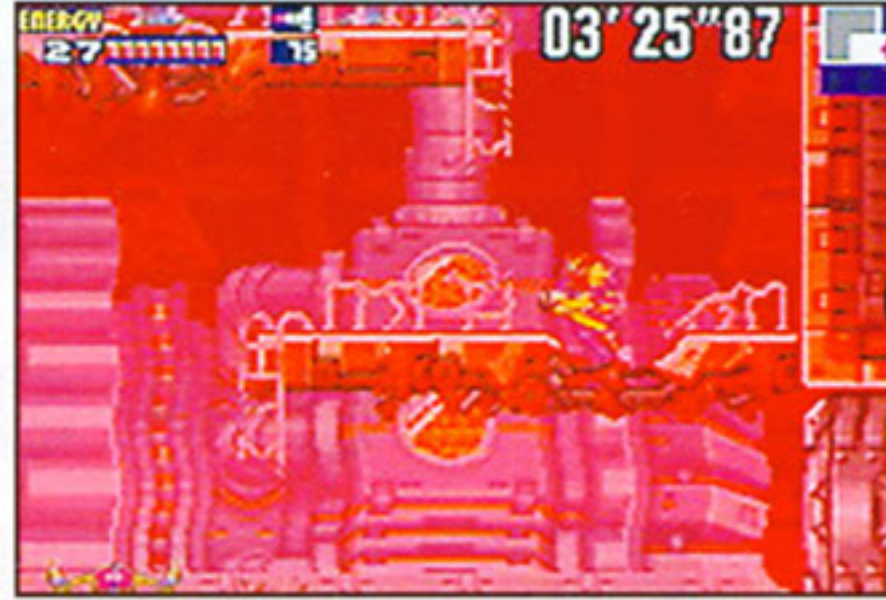

7 BOSS BATTLE

When you reach the controls, you'll find a scientist who has been consumed by the parasites. If you fire at the fiend, it will turn into a Core-X of the variety that you fought for the Bomb data. The creature has a small eye that fires projectiles. It's vulnerable only when the eye is open. Hit it with Ice Missiles and try to collect the parasites that it sheds. When the enemy is gone, you'll collect a large parasite that holds the data for the Wide Beam. Get the Beam, then turn on the station-cooling equipment.



Blast the Core-X with a Missile when its eye is open, then move out of the way.



Once the Core-X is gone and you have the Wide Beam, activate the cooling unit.

SECOND OBJECTIVE Proceed to the Navigation Room.

8 ROCKET FUEL

Trek through a lava-filled room and collect a Missile Tank, then use Bombs to blast your way into a new area. Clear the floor and run from right to left to charge your booster. Crouch before you hit the wall and press A to rocket up to a ledge. Run to the right and bomb the floor to make a pole rise from the ground. Jump up to a high ledge, run to the left and fire straight up to break through weak blocks. Then jump up, fire to the left and collect an Energy Tank.

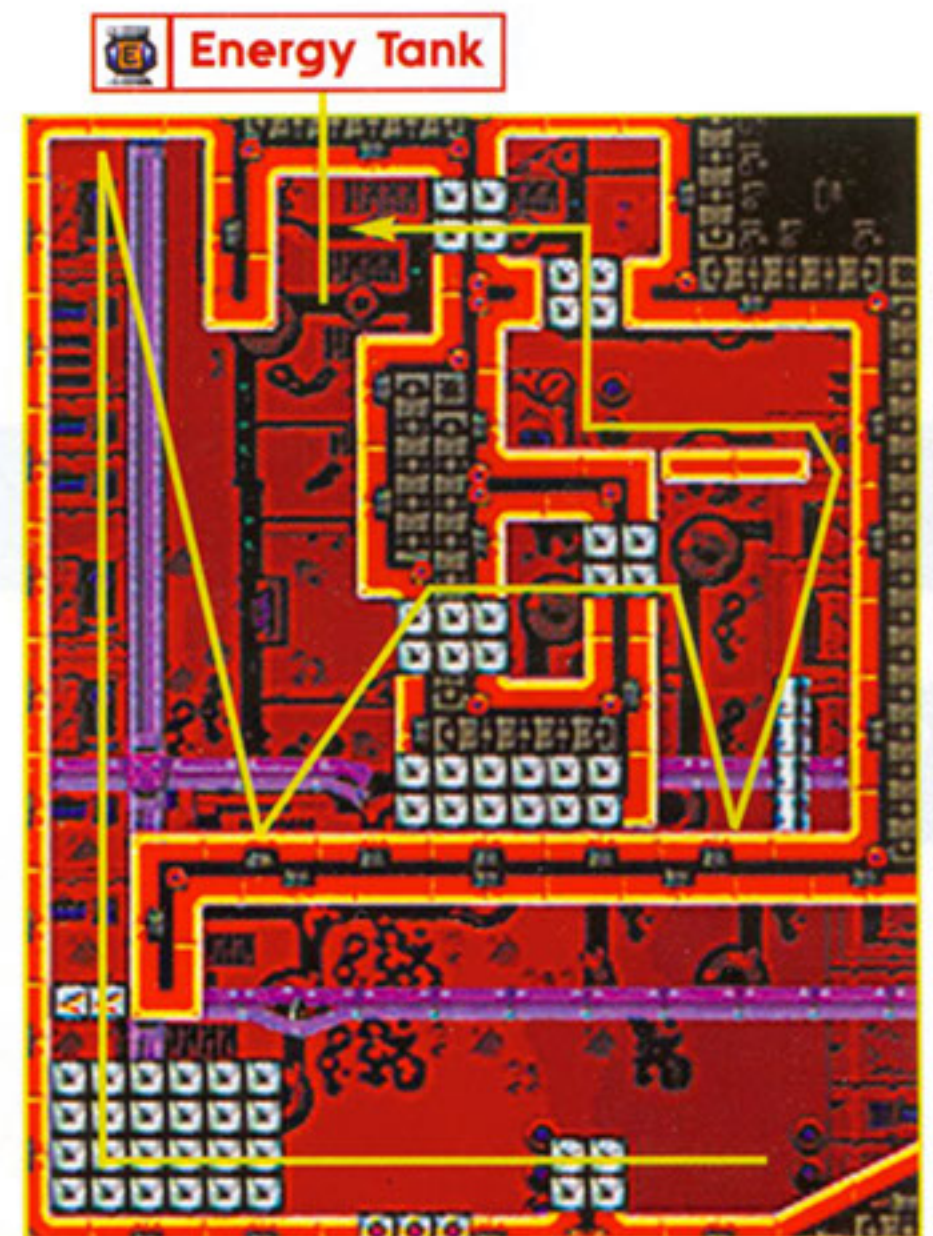
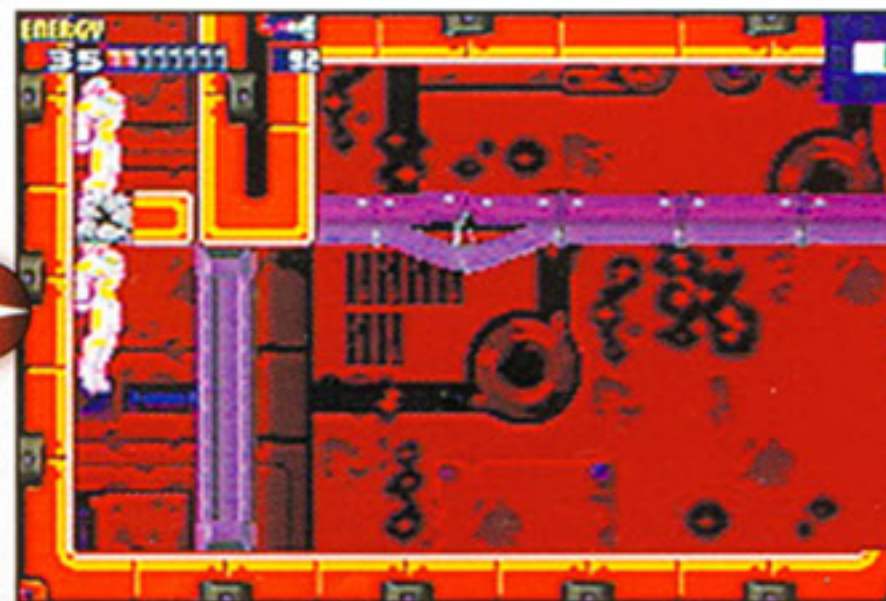
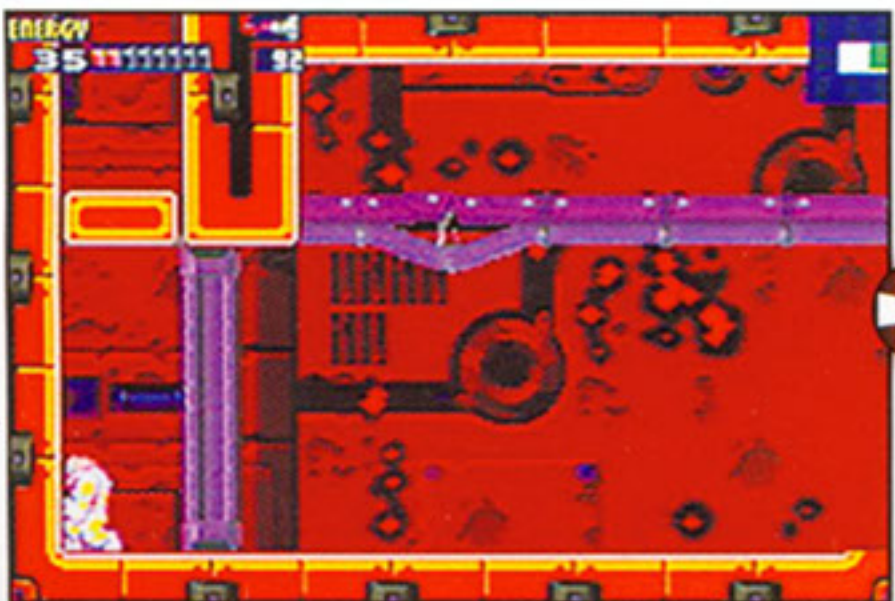

MAIN DECK

Could it be that some scientists have survived the parasite invasion? The computer is detecting lifeforms on the Habitation Deck—investigate.

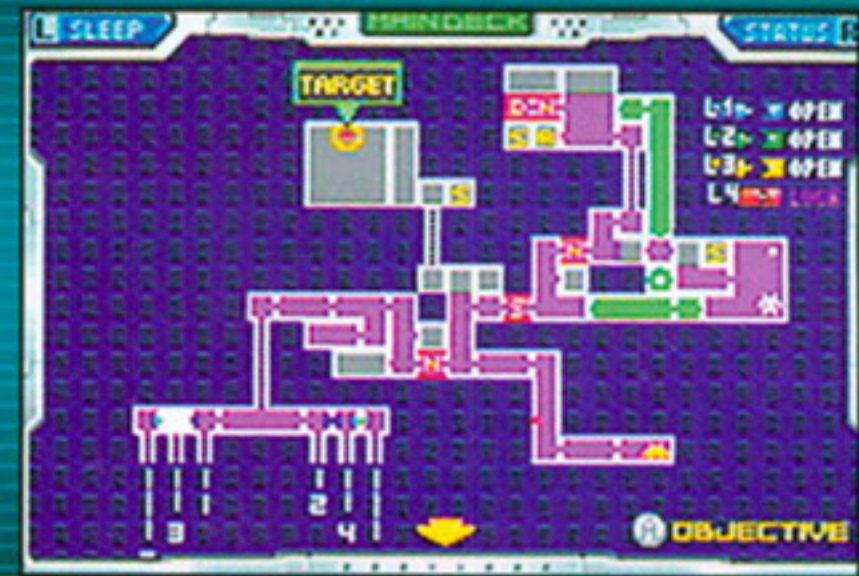

BLOCKS

- B** Bomb Block
- PB** Power Bomb Block
- M** Missile Block
- SB** Boost Block
- SA** Screw Attack Block

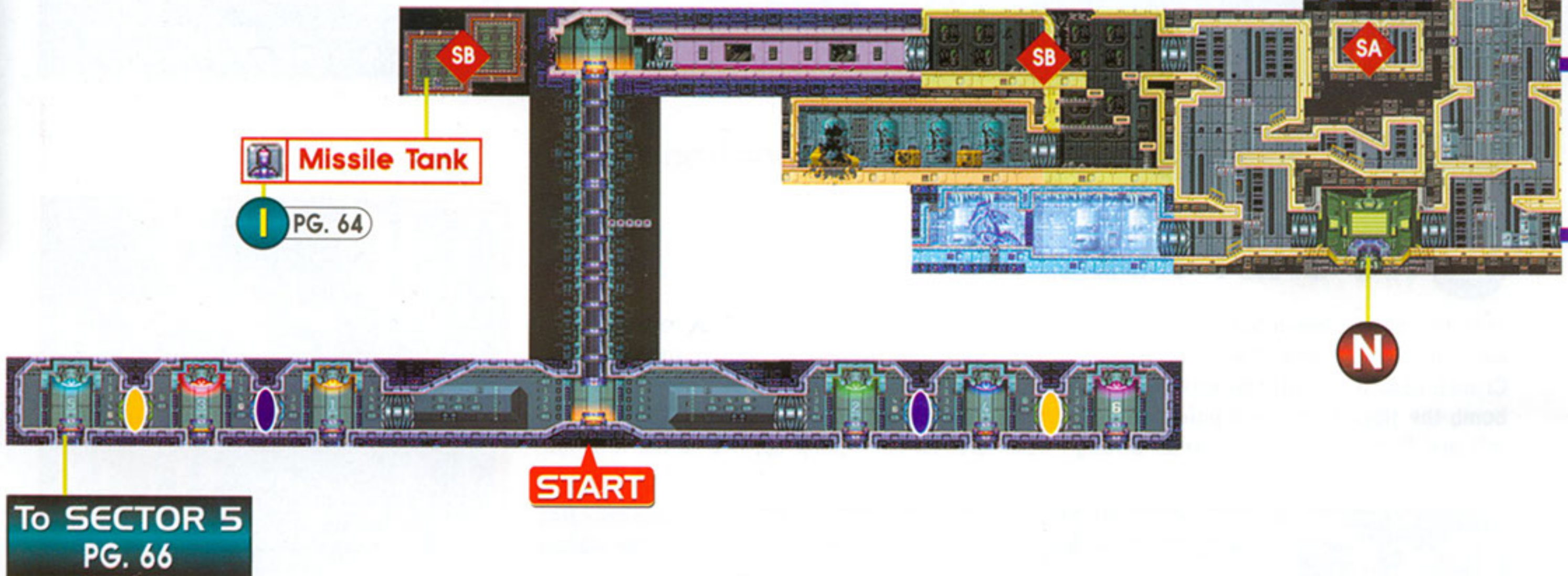
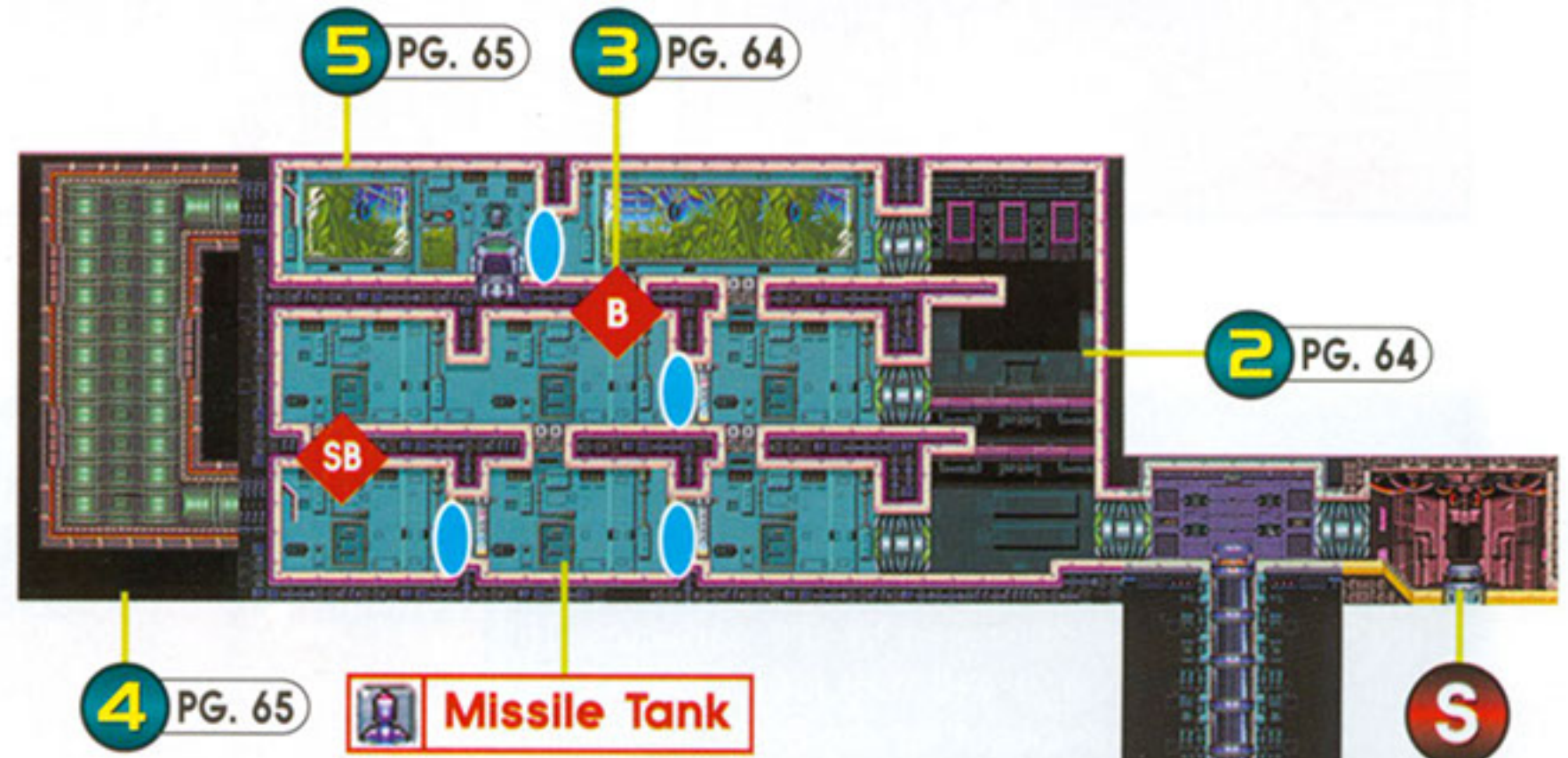

ROOMS AND HATCHES

- S** Save Room
- N** Navigation Room
- R** Recharge Room
- D** Data Room
- Level 1 Hatch
- Level 2 Hatch
- Level 3 Hatch
- Level 4 Hatch
- Special Hatch
- Shutter

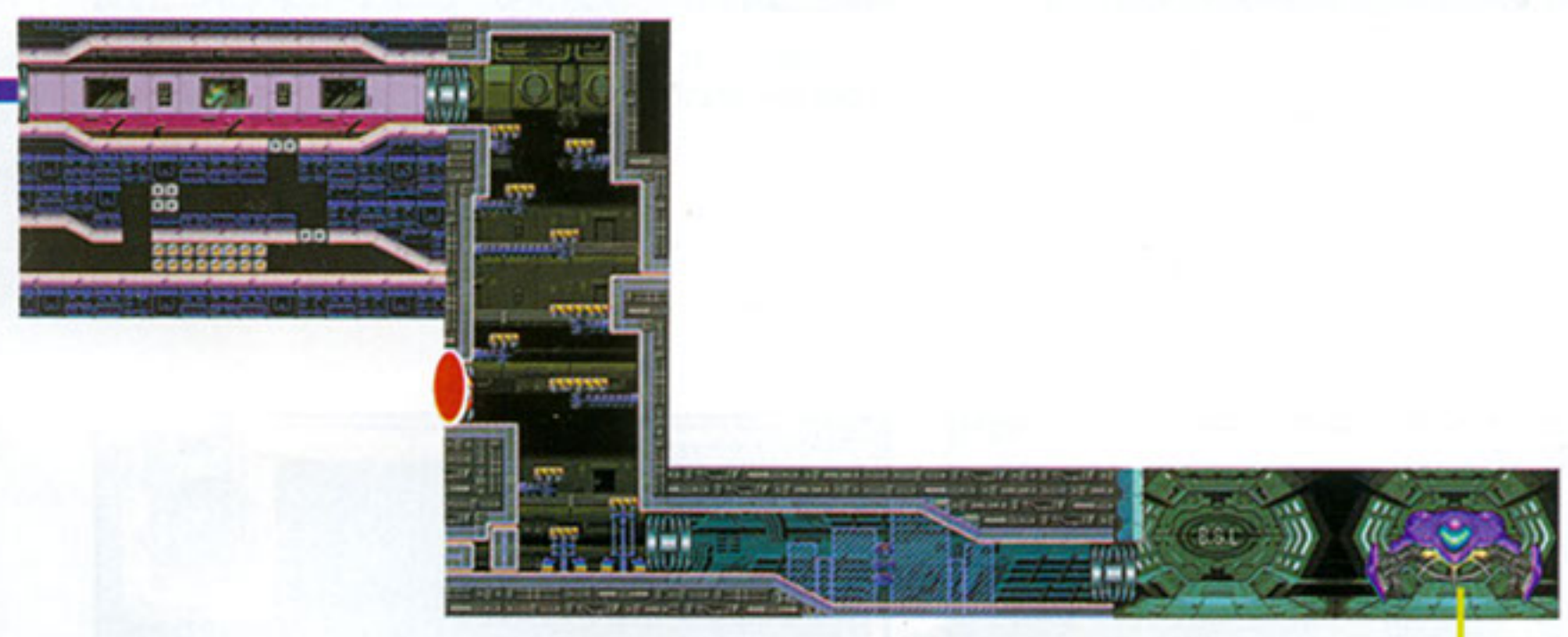
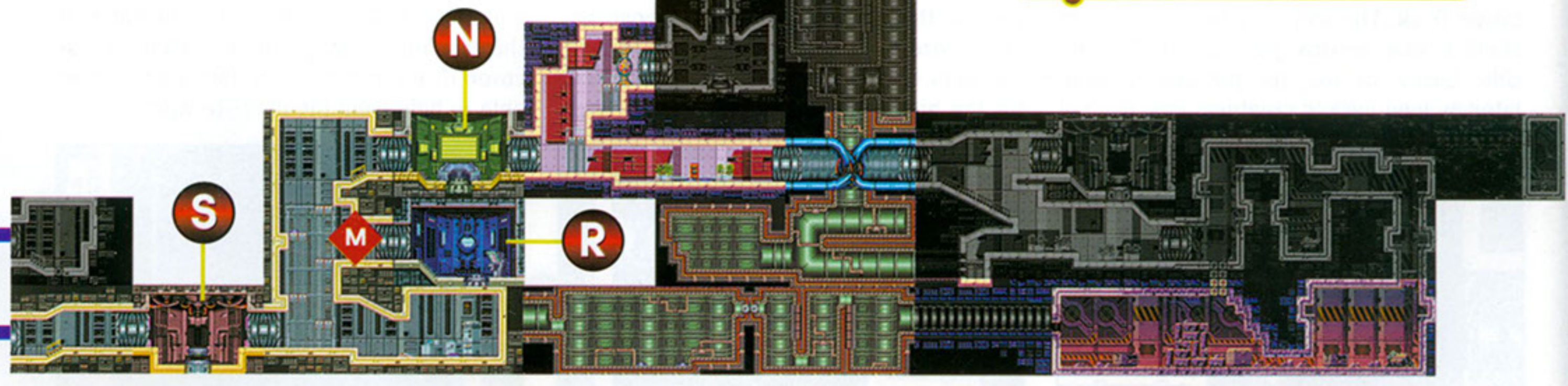
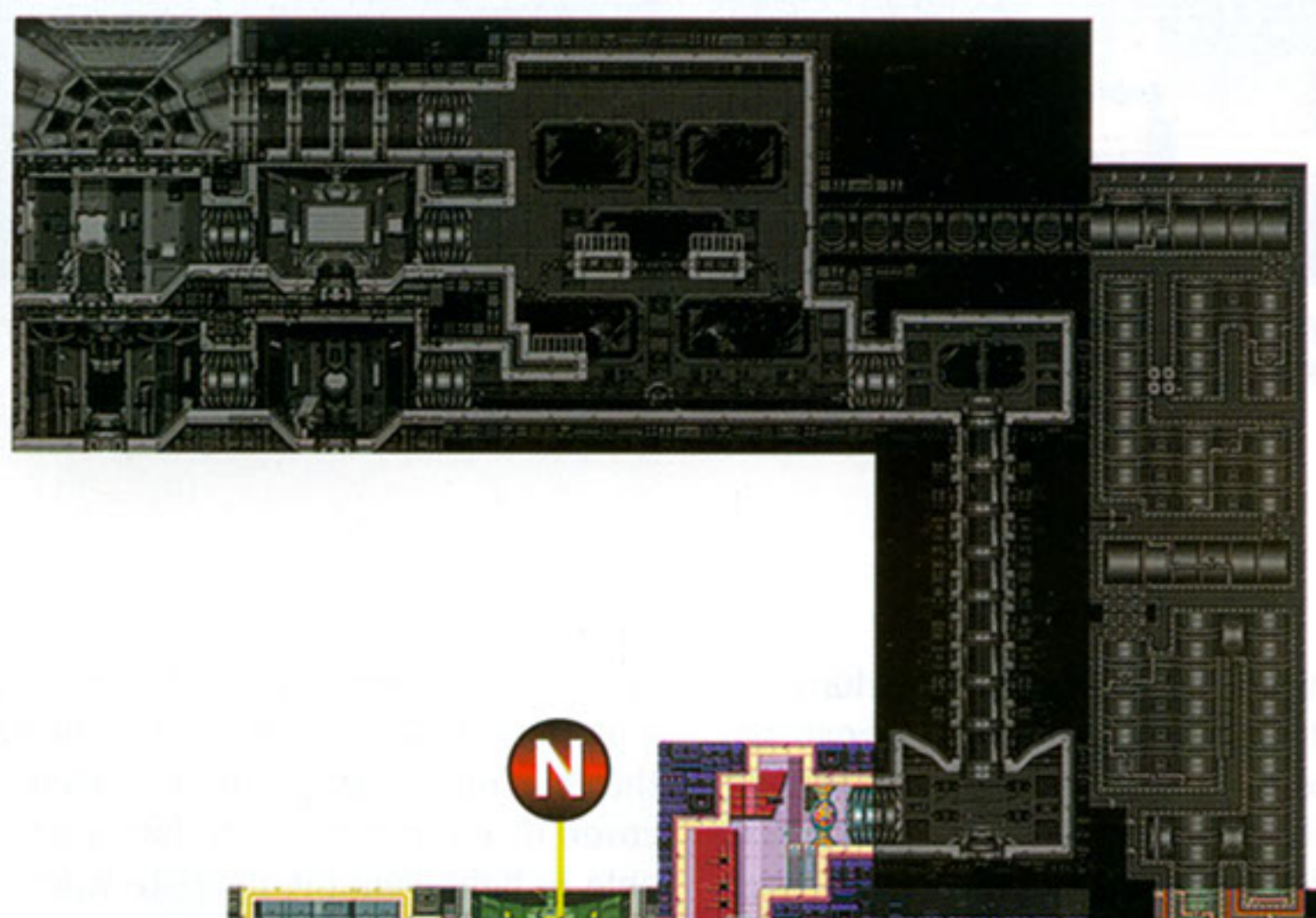

SHIP

OBJECTIVE Search the Habitation Deck for survivors.

1 RUNNING REWARD

You'll find a Missile Tank on the other side of a Boost Block barrier, to the left of the main elevator. Go to the right to give yourself a good running start, then run to the left, charge your Speed Booster and crash through the barrier. You'll hit the left wall and fall to the ground. Collect the tank and continue your quest.

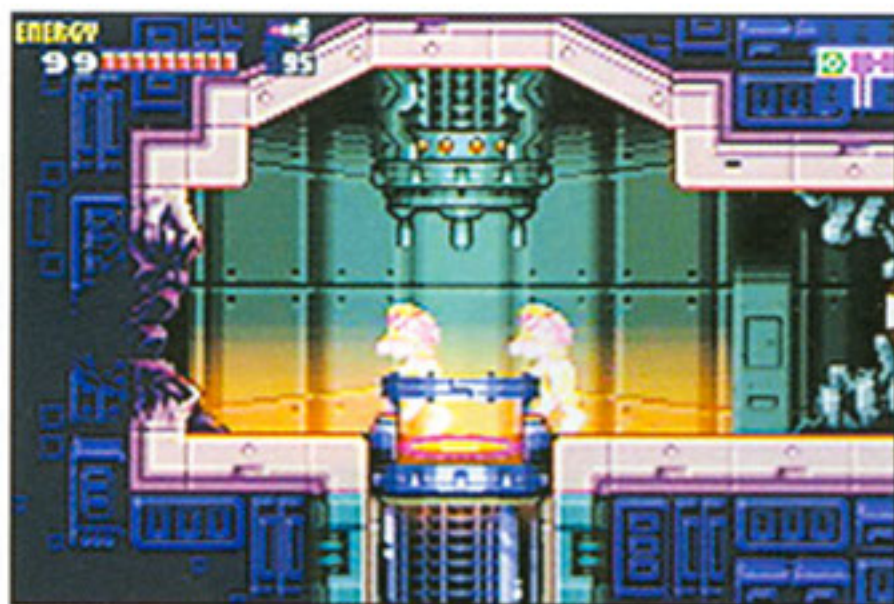

Run through the Main Deck, from right to left, to charge your Speed Booster.

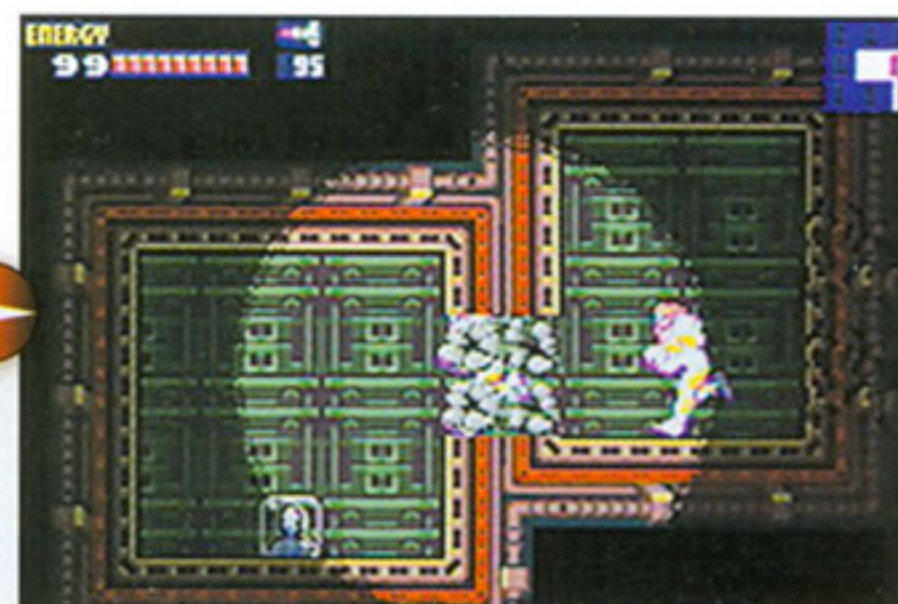

You'll break through a barrier of Boost Blocks and collect a Missile Tank.

2 BEAST BOOST

Your target is the top section of the Habitation Deck. The only way to reach it is to climb a long, vertical passage on the right side. Lucky for you, the passage is populated by long-necked creatures who pop out

from the wall. As you have done before, you can use the creatures as steps on your way up. Freeze the lower beast with a Missile, hop onto it, then jump left to a ledge. Wait for the higher creature to extend its neck,

hit it with a freezing projectile and use it as a platform to make your way to the hatch at the top. You're nearly there—ready to discover if any innocent life-forms have been able to hide from the parasite wave.

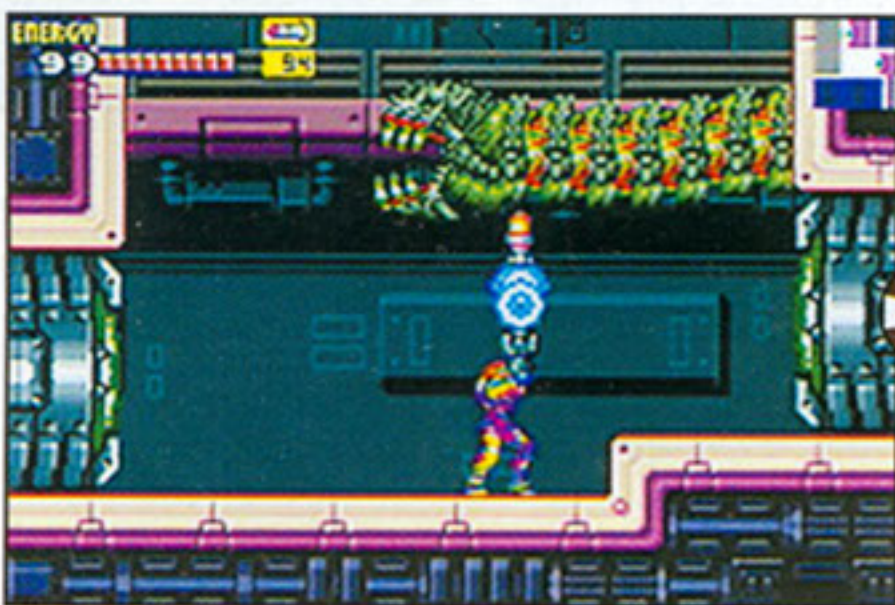

Freeze the lower creature with an Ice Missile, then jump up and use the beast to reach the ledge.

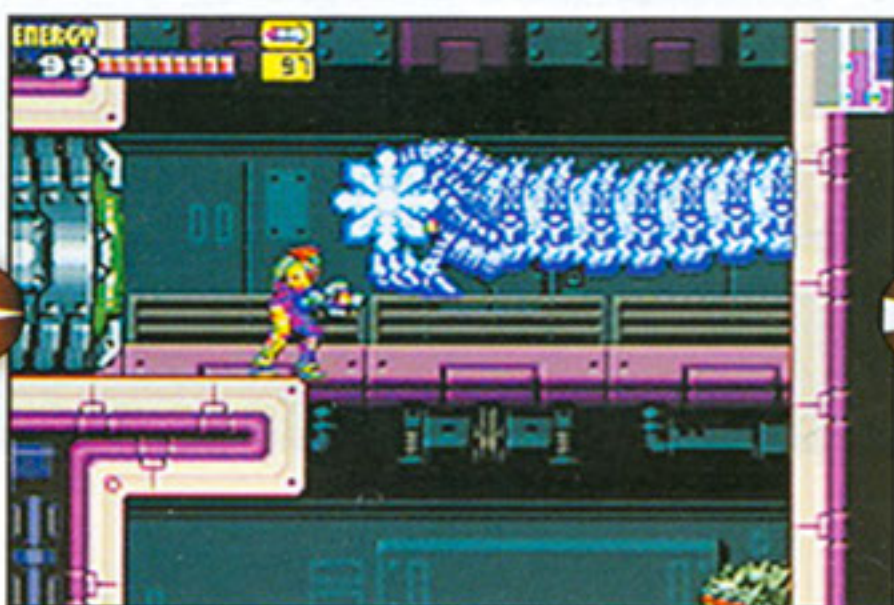

Wait on the ledge for the higher beast to extend its neck, then hit it with a Missile.

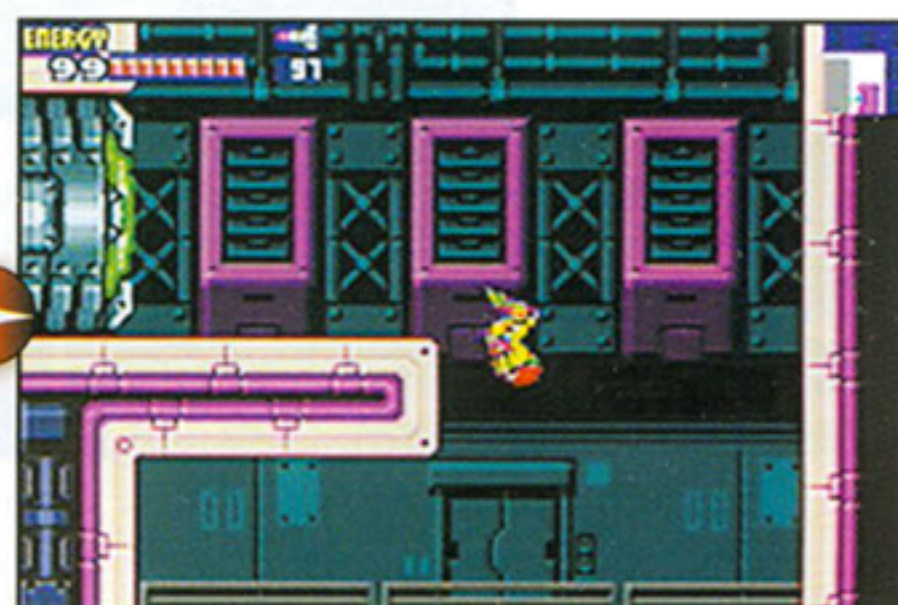

Hop from the frozen beast to the top ledge and prepare to explore the Habitation Deck.

3 BREAK IT DOWN

Before you can reach the other side of the shutter on the third floor, you must drop down to the lower-left corner of the Habitation Deck. Bomb your way down to the second floor, then open the shutter, run to the right and turn around at the hatch. Run to the left to make your booster charge, and break through two Boost Blocks on the floor. Stand on the exposed blocks and fall through them to the first floor.



Use Bombs to destroy blocks near the shutter on the third floor, then fall through to the second floor.

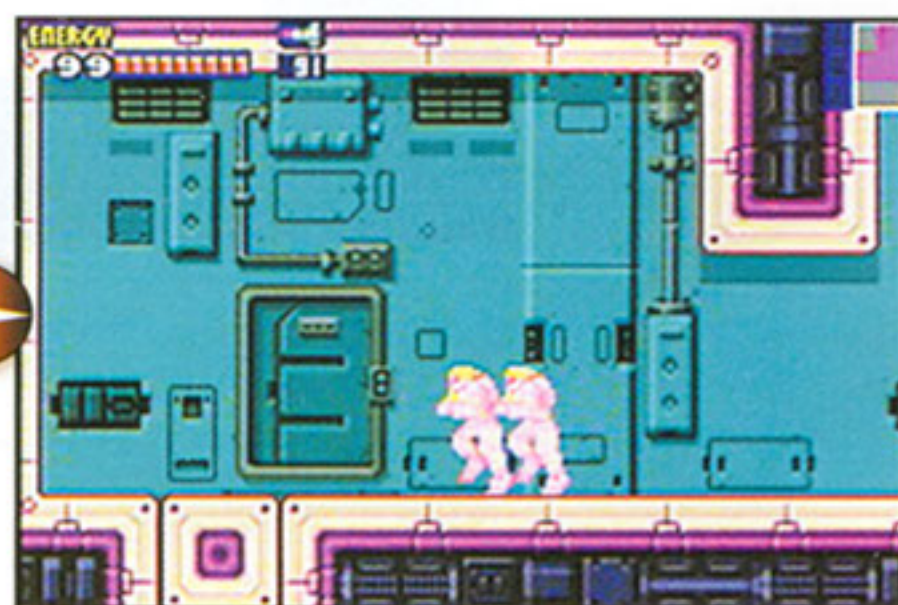

Open the second floor shutter, run to the right, turn and run to the left. You'll blaze through Boost Blocks.

4 TAKE THE TUBE

When you drop into the lower-left corner of the Habitation Deck and check the computer's map, you may believe that you've reached a dead end. But there is an unmapped vertical area that leads up the left

side of the deck. A twisted, metal door on the left wall marks the entrance to the area. Jump up and through the hole. You'll enter a dark tube that contains three long-necked beasts and three ladders. Climb the ladders,

freeze the beasts and use them as platforms. Their necks don't have to be extended—you can reach them even if they're just poking out. At the top, run to the right and into the upper-left section of the deck.

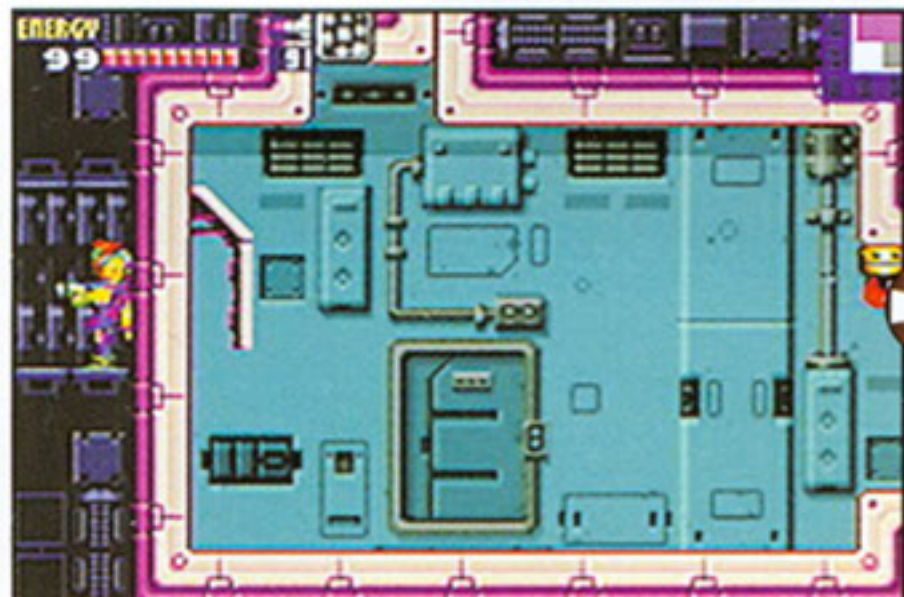

Jump up and to the left to enter an unmapped area of the Habitation Deck.



Climb the ladders and freeze the monsters, then use the frozen beasts as platforms.



When you reach the top of the passage, run to the right and drop into the third floor.

5 SAVE THE ANIMALS

The lock for the Habitation Deck is on the third floor. By standing on the pad, you'll unlock the gate and free the deck's inhabitants. Unfortunately, no humans survived the parasite attack, but you will discover that some animals have made it out alive. After you have a brief meeting with the friendly creatures, they will skitter off to another part of the Main Deck. You'll see the creatures again when you return to your ship. At least some life-forms will leave the station unscathed.



Step onto the pad to disengage the Habitation Deck lock and set the animals free.

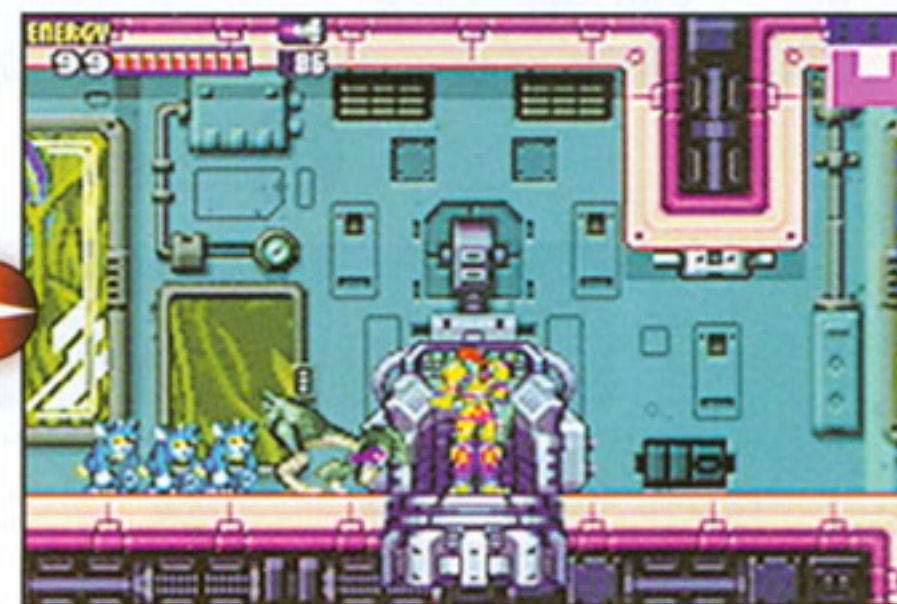

The animals will run from their cage, show their thanks, then leave for another area.

REUNION RECOLLECTION

As you take the Habitation Deck elevator down to the Main Deck, Samus will recall her last meeting with the creatures that she saved from the Habitation Deck. Those same creatures were on Zebes. They helped her learn some useful moves that are still in her repertoire.

Etectoos and Dachoras. I've met these intelligent beings before. They seemed to recognize me, as well. How unusual to meet again here. In the past, they've helped me unleash abilities I didn't know I had. But where did they run to? I hope they're safe...

Samus remembers her animal friends in a moment of reflection as she returns to the Main Deck and continues her quest.

SECTOR 5

ARC

The stakes have been raised in your war against the parasites. You need more firepower. Return to the Sector 5 Data Room for the Power Bombs.

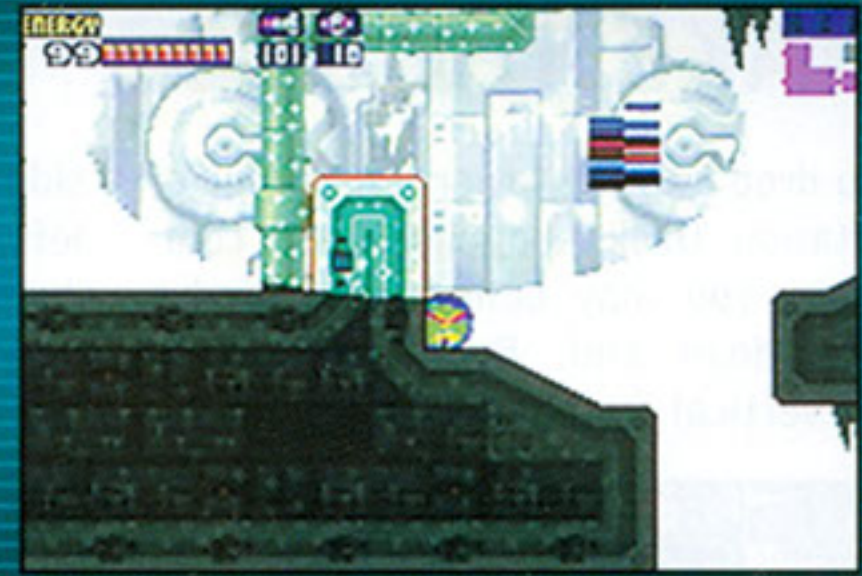

START

To MAIN DECK
PG. 70

N

S

R

1 PG. 68

Power Bomb Tank

2 PG. 68

7 PG. 69

Missile Tank

8 PG. 69

6 PG. 69

5 PG. 69

Power Bomb Tank

S

- BLOCKS**
- B** Bomb Block
 - PB** Power Bomb Block
 - M** Missile Block
 - SB** Boost Block
 - SA** Screw Attack Block

- ROOMS AND HATCHES**
- S** Save Room
 - N** Navigation Room
 - R** Recharge Room
 - D** Data Room
 - Level 1 Hatch
 - Level 2 Hatch
 - Level 3 Hatch
 - Level 4 Hatch
 - Special Hatch
 - Shutter

3 PG. 68

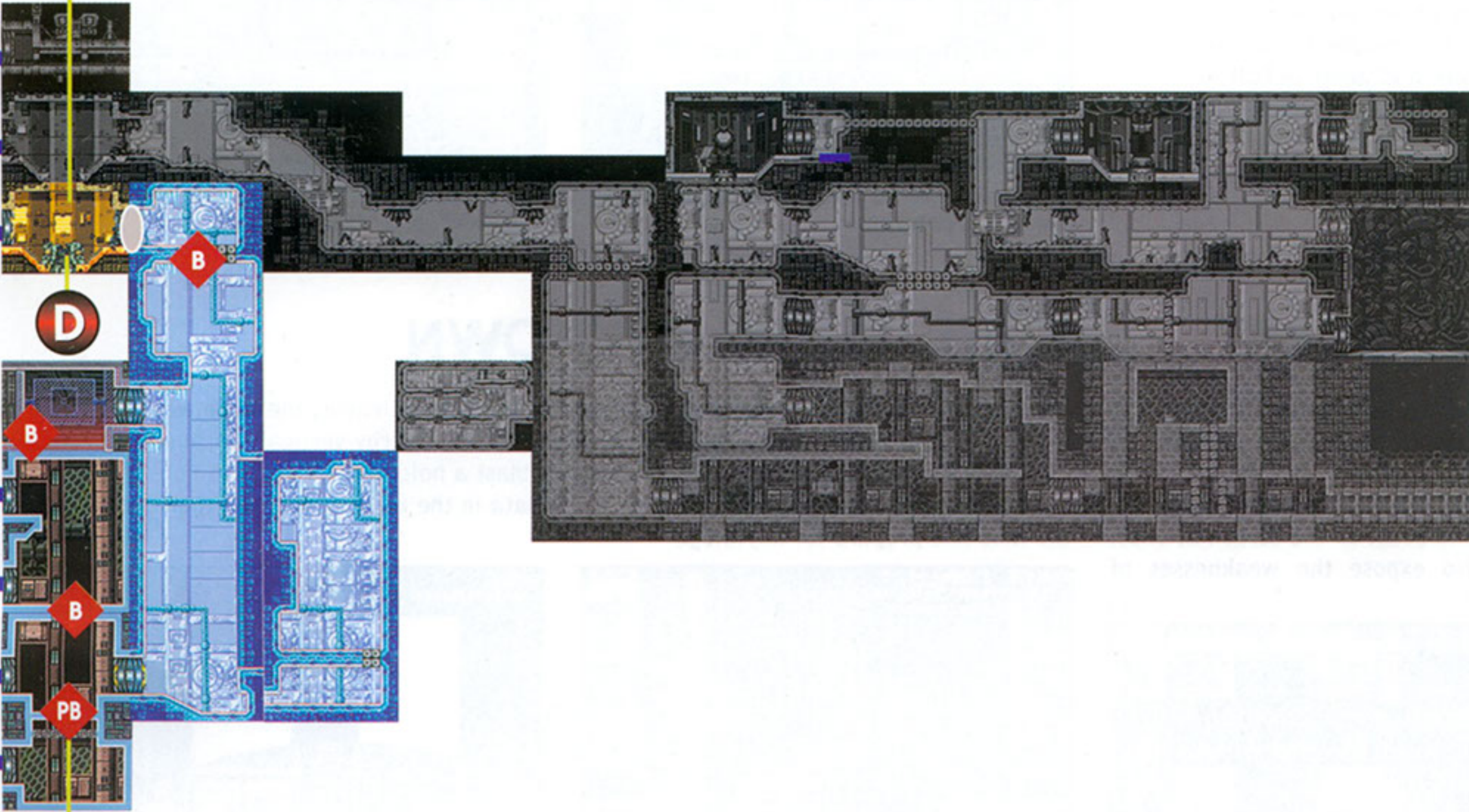

4 PG. 68

FIRST OBJECTIVE Proceed to the Data Room.

1 PARASITE INVASION

The creatures are multiplying. When you return to the passages of Sector 5, several enemies will be there to greet you. Some will fire projectiles, others will attack by flying into you. They may seem like small and insignificant enemies, but they can easily sap your energy reserves. Defeat the enemies and don't let any of their parasites get away. If the parasites escape, the creatures will reform.



Aim and fire your Wide Beam at the Sector 5 wall-crawlers before they have a chance to hit you.



As you explore the passages, don't pass up an opportunity to collect an X parasite.

2 MISSILE MOVE

After you drop to the bottom of the first vertical section, take a quick detour to the left. You'll enter a room full of creatures that walk on walls and ceilings. Defeat the beasts and collect their parasites. Then concentrate your efforts on collecting the Missile Tank in the middle of the room. Roll along the floor and jump, in ball form, into the lower-left corner of the Missile Tank's container. Then roll and collect.

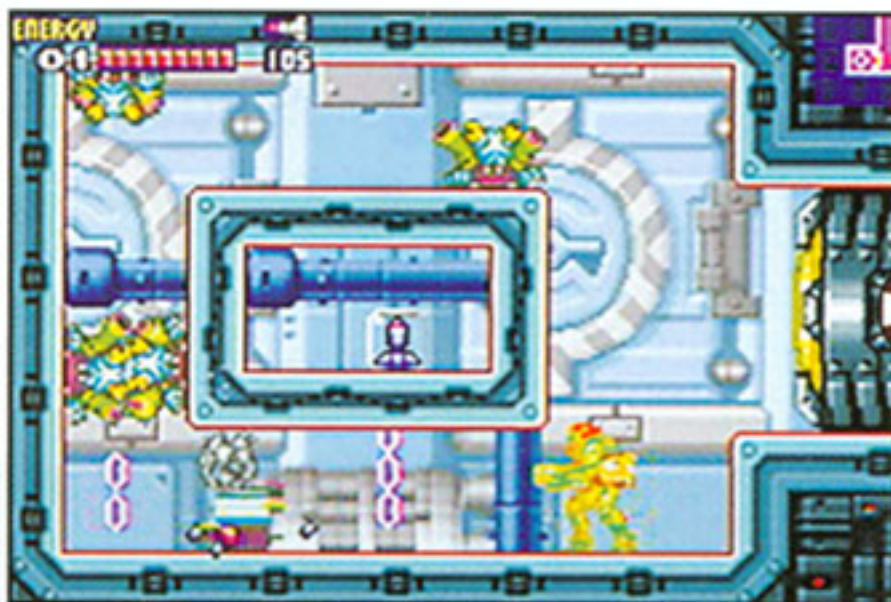

Defeat all of the enemies in the small room and collect all of their parasites.

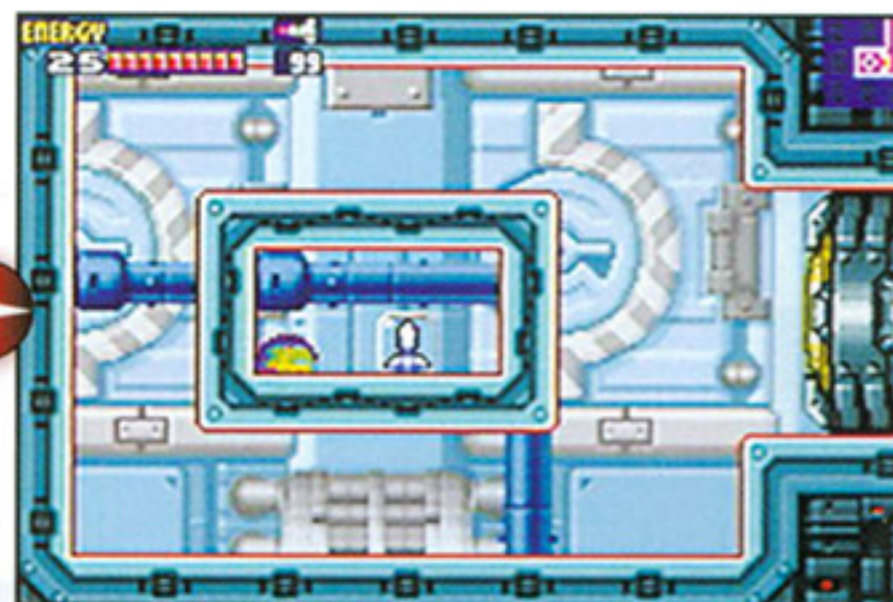

Roll and jump through the floor of the container to gain access to the Missile Tank.

3 BIG BLAST

The computer has sent Power Bomb data to the Sector 5 Data Room. Step onto the pad and collect the explosive information. With Power Bombs, you can destroy every bombable block and beast on the screen at once. You can also expose the weaknesses of other blocks.

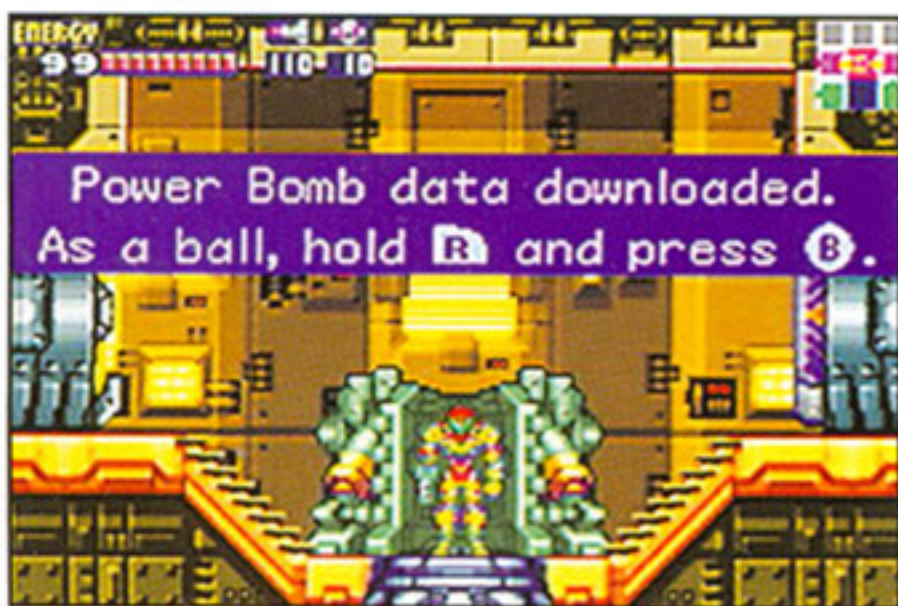

Download the Power Bomb data and become an explosive force.

4 INTO THE UNKNOWN

The one-way shutter near the Data Room prevents you from leaving the same way that you entered, just as before. Drop down to the bottom of the nearby vertical passage, then run one room to the left and use a Power Bomb to blast a hole in the floor. The hole leads to a previously unexplored area. Save your game data in the room to the left, then drop into the hole and prepare for anything.



The standard Bomb will expose the destroyable block, but it won't break the block.

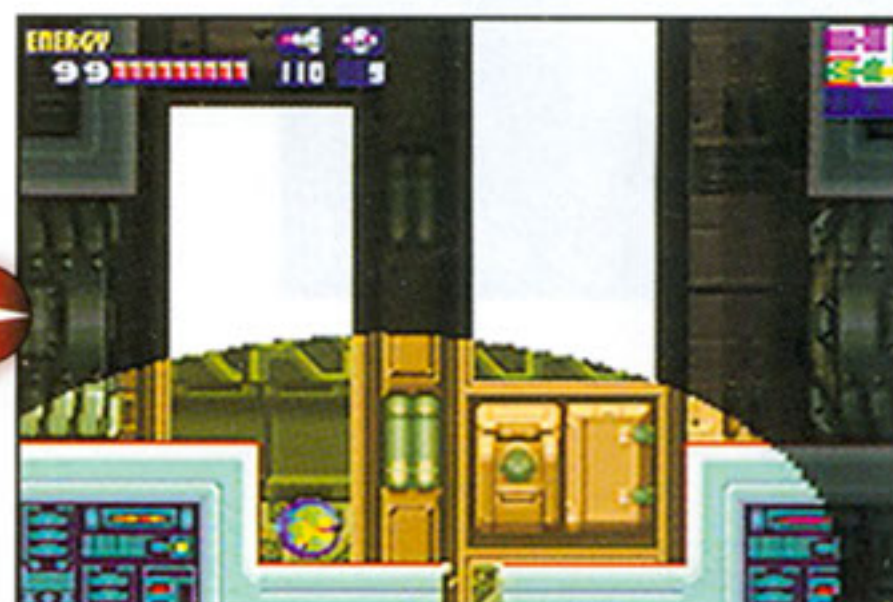

Use a Power Bomb to bust the Power Bomb Block, then drop into a new area.

SECOND OBJECTIVE Proceed to the Navigation Room.**5 SA-X ALERT**

Shortly after you start to explore the new area, the SA-X will find you and run after you. Run to the left, climb over a wall and detonate a Power Bomb to expose passages in another wall. The lower passage is a dead end. Jump up to the higher passage, as a Morph Ball, and roll through to the left. If you can reach the room at the end of the hall alive, you'll escape the SA-X safely. Use a Power Bomb there to open a hole in the ceiling.



Roll into Morph Ball form and take the higher passage to the left. The lower passage is a dead end.

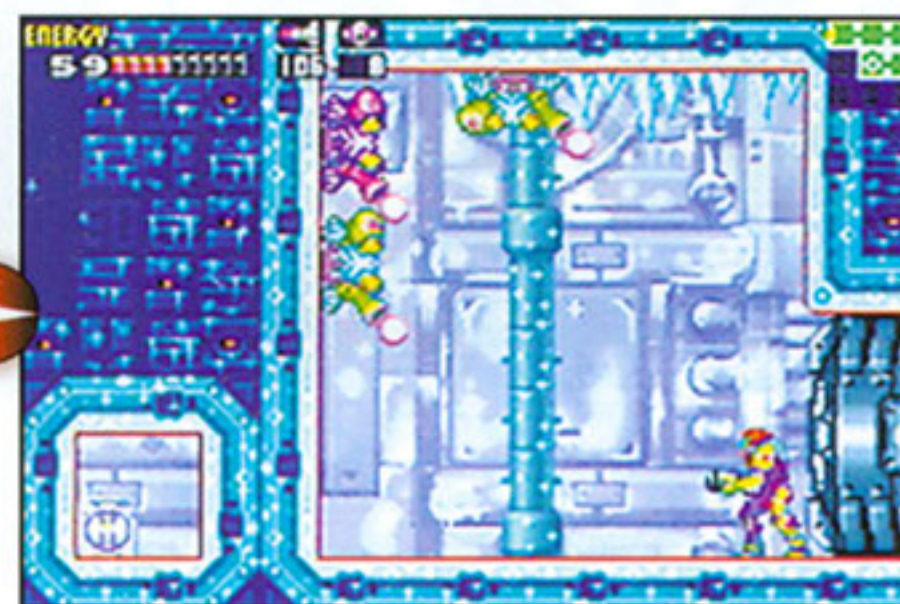

When you reach the end of the path, use a Power Bomb to expose a hole in the ceiling.

6 FREEZE UP

Expose another hole in the ceiling by using a Power Bomb, and climb up into a vertical passage. Small, invincible creatures slide back and forth in the passage. You can climb to the top of the passage by freezing the creatures with Missiles and using them as platforms. Time is tight. If you stand on one of the creatures for too long, it will thaw out and you will fall to the bottom of the passage. You'll find a Power Bomb Tank at the top.

**7 BEAST BLAST**

A large organic barrier blocks the passage to the Navigation Room. You've seen the same type of creature before, but you didn't have the firepower to defeat it. Use a Power Bomb to blow it away.

**8 ROLL TO THE TANK**

A tight passage in the middle of the sector leads to a Power Bomb Tank. Use a Power Bomb to reveal three sections of breakaway blocks. Jump, as a Morph Ball, up to the

narrow passage, then straighten out and hit the first enemy with an Ice Missile as it hovers over the first block section. Roll to the next section and repeat the trick. Then

roll to the edge of the ledge and jump over the last group of blocks to reach the Power Bomb Tank.

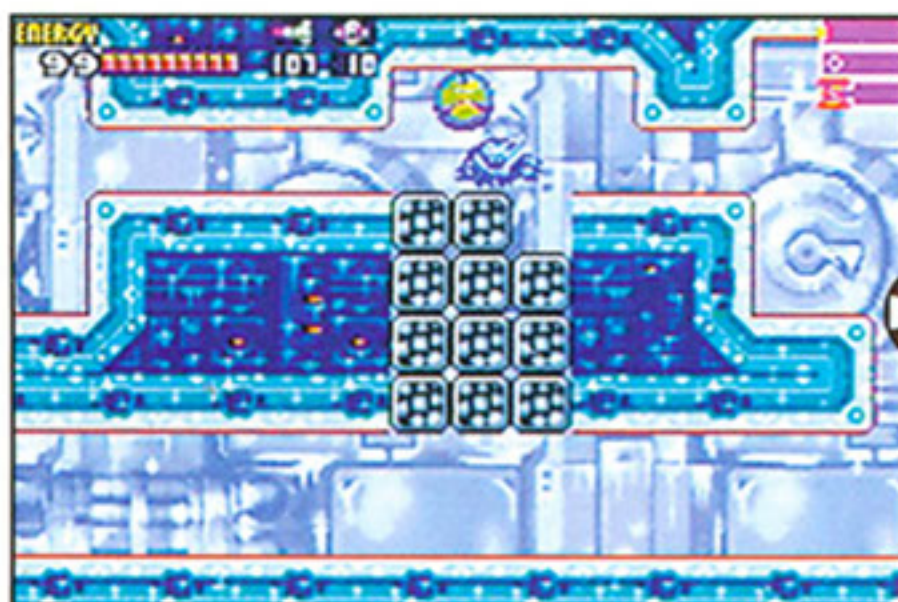

Freeze the first enemy, then roll up and use the enemy as a platform to get over the hole.



The second hole is wider than the first one. You'll have to freeze the enemy in the middle.



Jump over the last hole and collect the Power Bomb Tank. You earned it.

MAIN DECK

A bad situation is getting worse. The computer won't elaborate on its orders, but it wants you to return to your ship. You can recharge and regroup there.

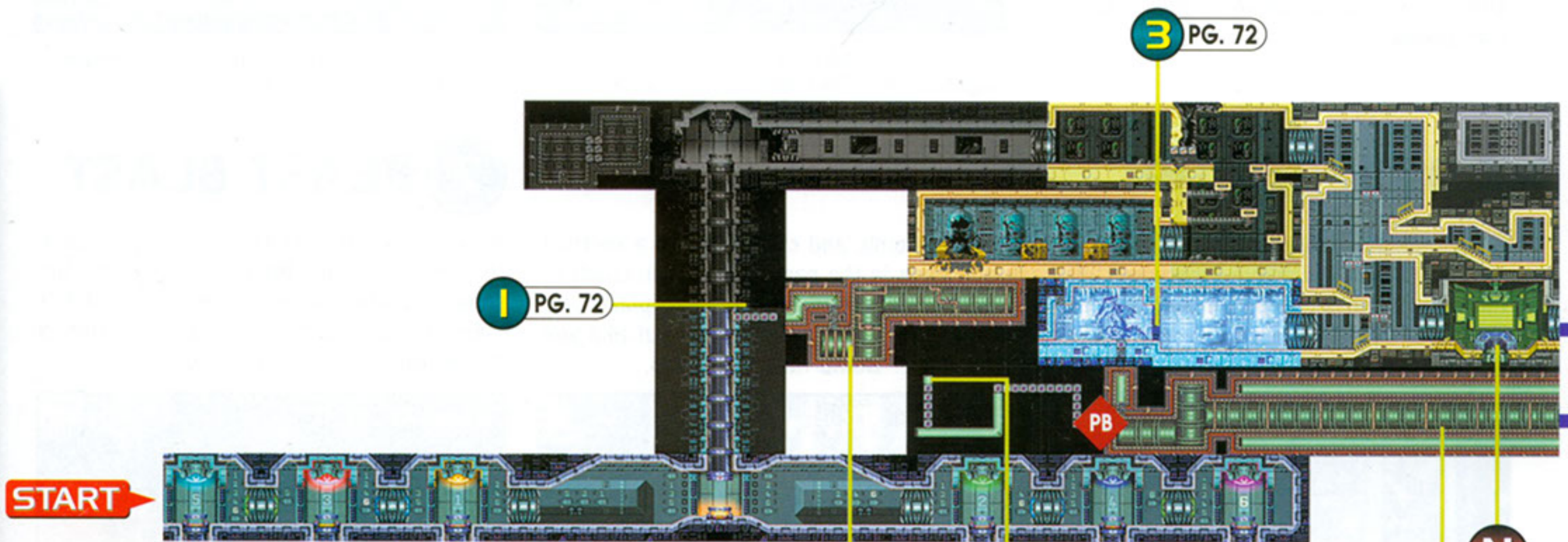

ROOMS AND HATCHES

- S** Save Room
- N** Navigation Room
- R** Recharge Room
- D** Data Room
- Level 1 Hatch
- Level 2 Hatch
- Level 3 Hatch
- Level 4 Hatch
- Special Hatch
- Shutter

BLOCKS

- B** Bomb Block
- PB** Power Bomb Block
- M** Missile Block
- SB** Boost Block
- SA** Screw Attack Block

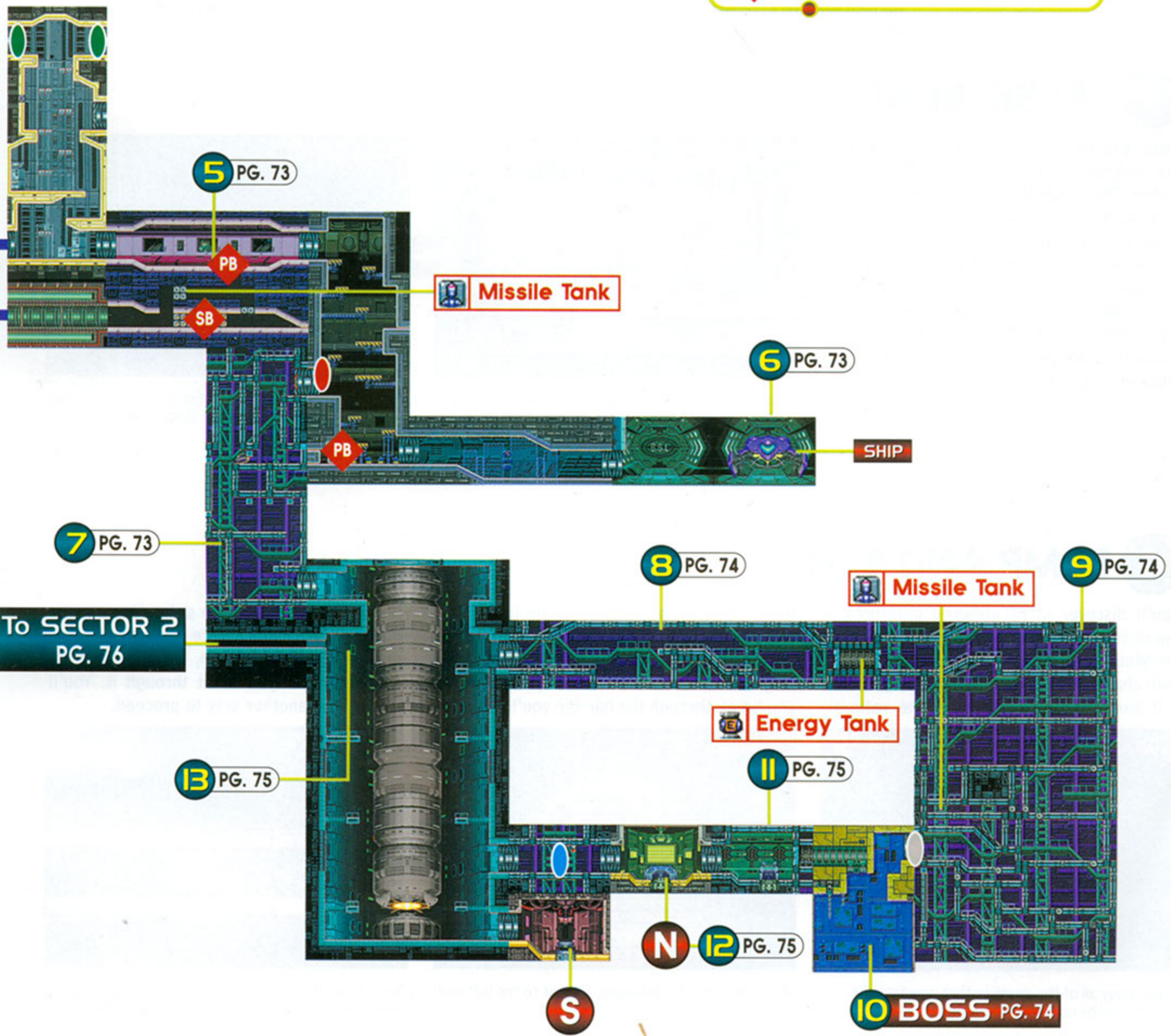

FIRST OBJECTIVE Return to your ship.

1 EMERGENCY EXIT

Your ride on the main elevator will be cut short by a power outage. The X parasites have cut into the station's electrical supply. Use Bombs to reveal an exit on the right wall, and roll through a tight passage.

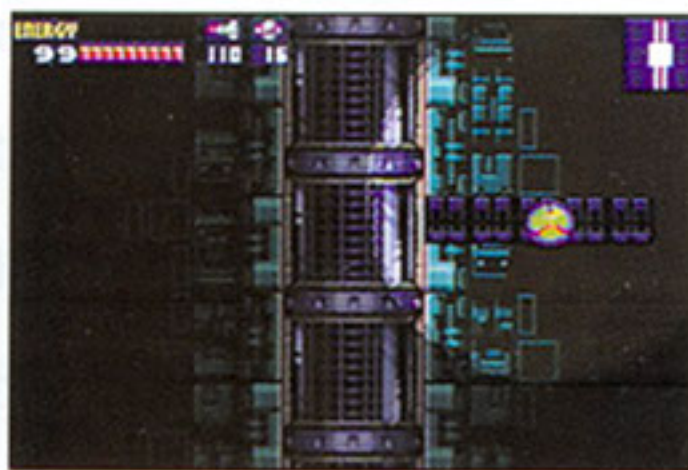

Hop in ball form and plant a Bomb near the right wall. You'll find an alternate exit.

2 ARMORED ENEMIES

The spiked creatures in the unmapped passage will stop and cover themselves with armor as you close in on them. Use a charged-up Beam shot or a Power Bomb blast to defeat them.

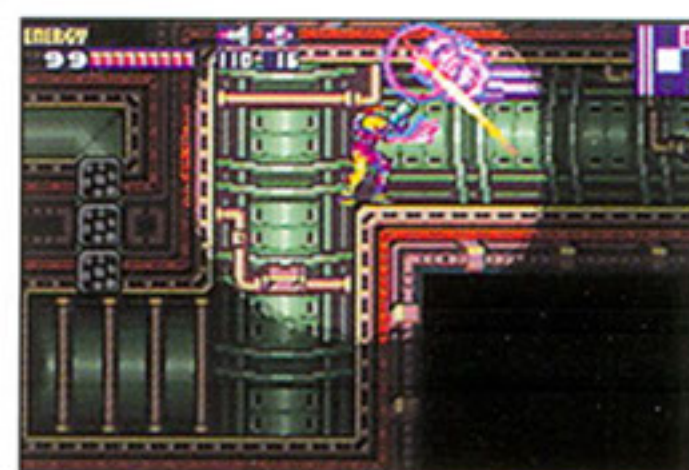

Your Charge Beam cuts through the armor of the wall-crawling creatures.

3 FALSE ALARM

After you roll through a hidden tunnel to the refrigeration section, you'll discover Ridley. The crystallized creature will begin to move then collapse and produce a large X parasite. The parasite will open a hole in the floor as it leaves. After you drop into the hole, use a Power Bomb to reveal a tunnel in the left wall. Roll to the end of the tunnel then use another Power Bomb. You'll discover a Power Bomb Tank. Stand and jump to collect it.



You may think for a moment that you're in for a fight, but the icy creature will collapse and open a hole.

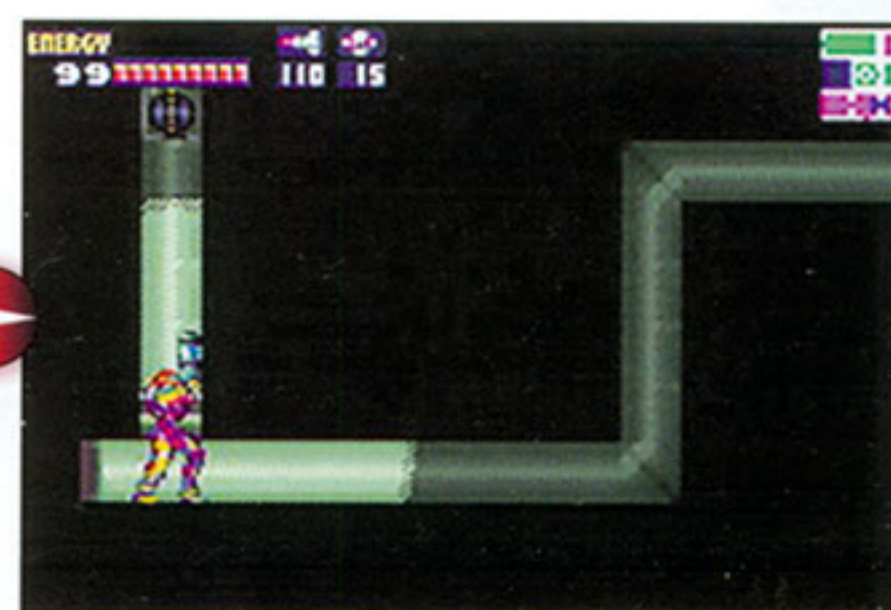

After you drop through the floor, use Power Bombs to open a passage to a Power Bomb Tank.

4 BUMP AND RUN

You'll discover more armored creatures in the unmapped tunnel in the lower section of the Main Deck. Clear the passage of enemies with charged shots (not even a Power Bomb will hurt the creatures above the rafters),

then return to the left end of the tunnel and run to the right. When your Speed Booster charges up, you'll be able to run through four large obstacles in the tunnel. Not long after you break through the barrier, you'll find that

the passage narrows to a point. You may be tempted to try to squeeze through the passage in Morph Ball form, but the tunnel is too narrow for you to fit through it. You'll have to find another way to proceed.



Clear away all of the enemies that populate the main tunnel by using charged shots.

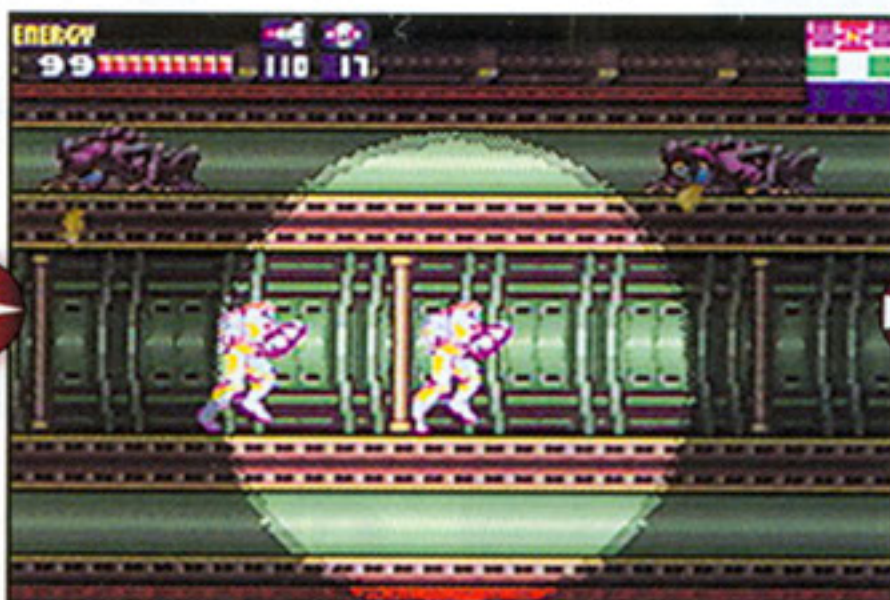

After the enemies are gone, retreat to the left end of the tunnel, turn and run to the right.

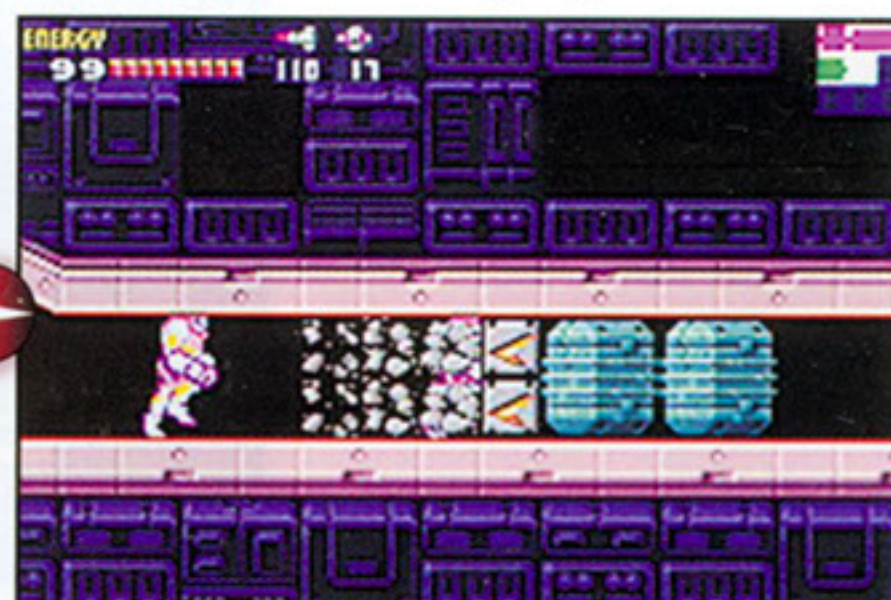

You'll blast through four large obstacles at super speed and continue to the tunnel's tapered end.

5 POWER TO THE ADVENTURER

You'll quickly learn that Power Bombs are very useful tools in dead ends. All you have to do at the tapered end of the tunnel is detonate a Power Bomb to open a hole in the ceiling. Jump up and collect a Missile Tank, then jump up again and join the main path to the ship. The elevator emergency will have been averted. You'll be back on track and on your way to learn your next mission objective.



Detonate a Power Bomb to reveal a hole in the ceiling and a path to a Missile Tank.



After you collect the tank, jump up and run to the right. You're closing in on the ship.

6 CORE PROBLEM

When you reach your ship, you'll discover that the power outage was caused by a problem with the main reactor core. You must find the switch for the auxiliary power system in an unmapped area below the Main Deck and turn it on before you can proceed with your main objectives. After the computer briefs you on the situation, it will show you that the creatures you saved on the Habitation Deck have made it to the ship in one piece. They're packed and ready to go.



The ship is a one-stop service station. You can recharge weapons and energy and save your game.



The computer will brief you on your next mission—turn on the auxiliary power.

SECOND OBJECTIVE Engage auxiliary power.

7 ONCE MORE, INTO THE BREACH

The station's power system is located way below the Main Deck. After you leave the ship, run to the left end of the Docking Bay and detonate a Power Bomb to open a passage that leads to the left and down, into a maze of girders and ladders. Many of the

girders have weak sections. Roll along them and plant Bombs to create holes, or destroy all breakable sections in sight with a Power Bomb. When you reach the Central Reactor Core, you'll encounter a large room with sections that are blocked by withered roots

and plants. You can blast away at the plant life with your Wide Beam. There's a Save Room in the lower-right corner of the area, but it won't be operational, because of the power failure. You'll have to continue without saving your game data.

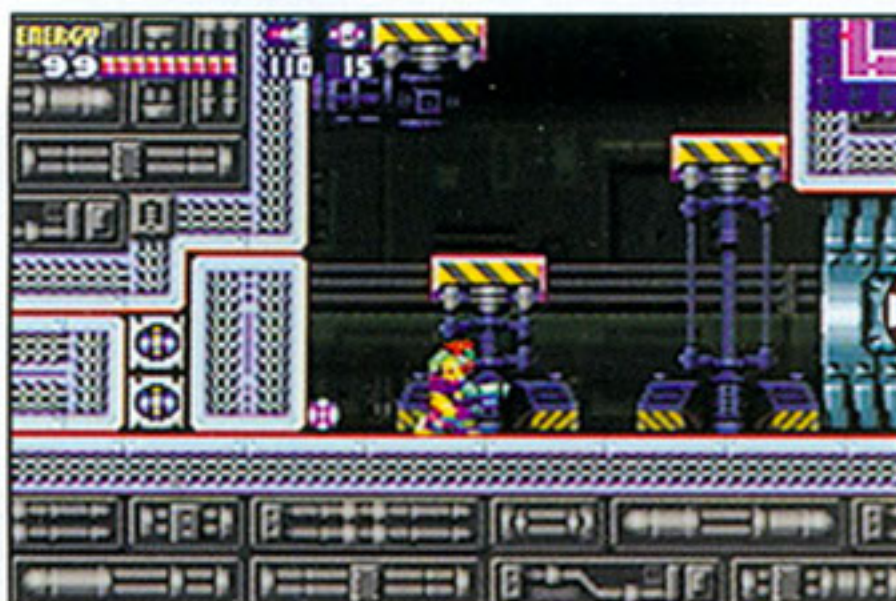

Use a Power Bomb in the lower-left corner of the Docking Bay to blast through a barrier.

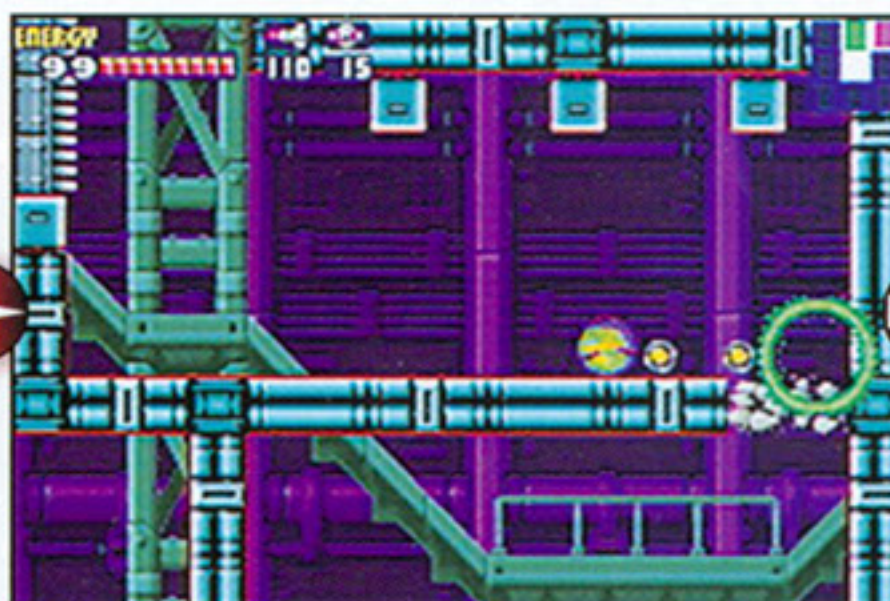

Some sections of the girder network are weak. Destroy them with standard Bombs.

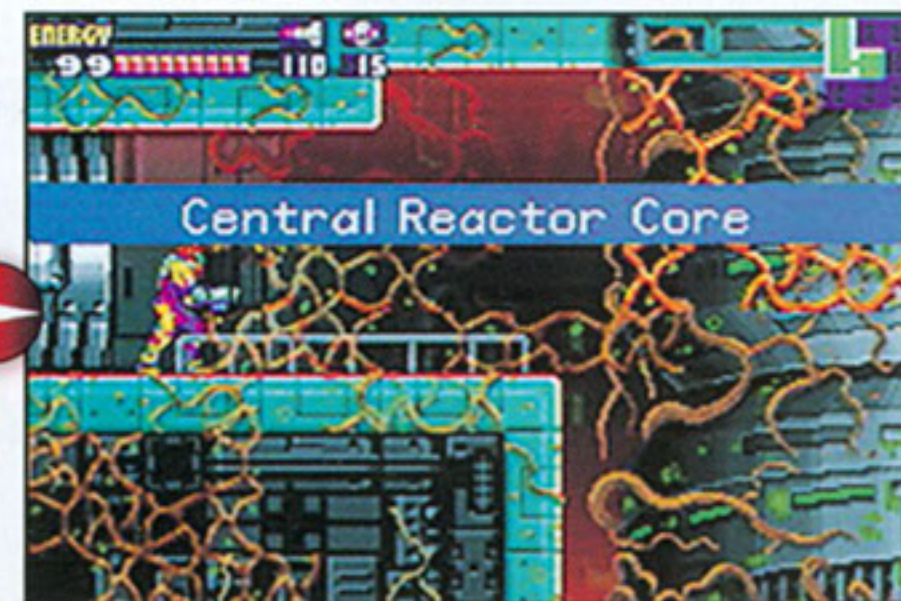

Cut through the branches and roots at the Central Reactor Core and continue your quest.

8 FIRE AWAY

You'll discover a path to the area boss in the upper-right section of the Central Reactor Core. As you move along the top part of the path, you'll face off with Zebesian Space Pirates who have been consumed by X parasites. As long as you are a step above the pirates, they can't hurt you. Keep to the high ground and fire on the enemies with charged Wide Beam shots. Each creature will leave two parasites.

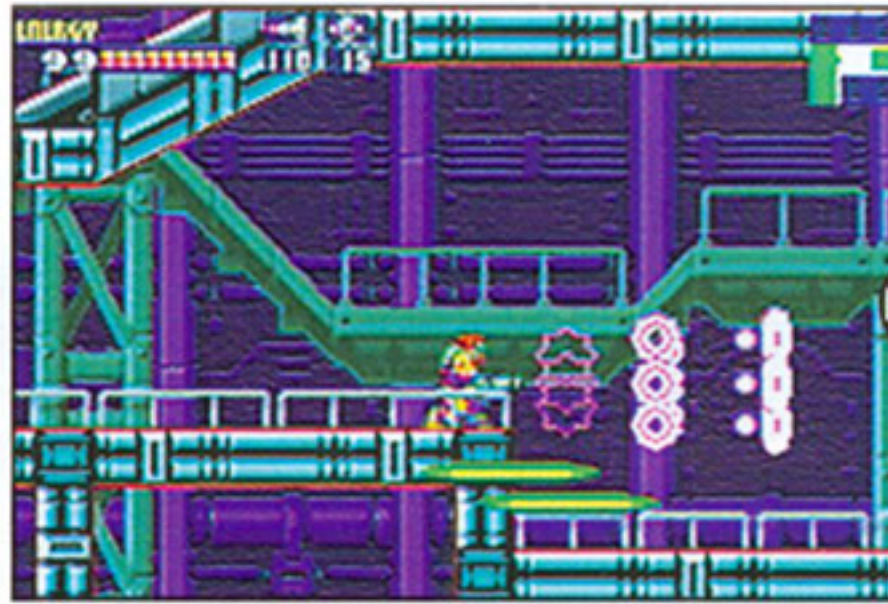

Charge your beam and fire to the right. You can beat one of the pirates without even seeing it.

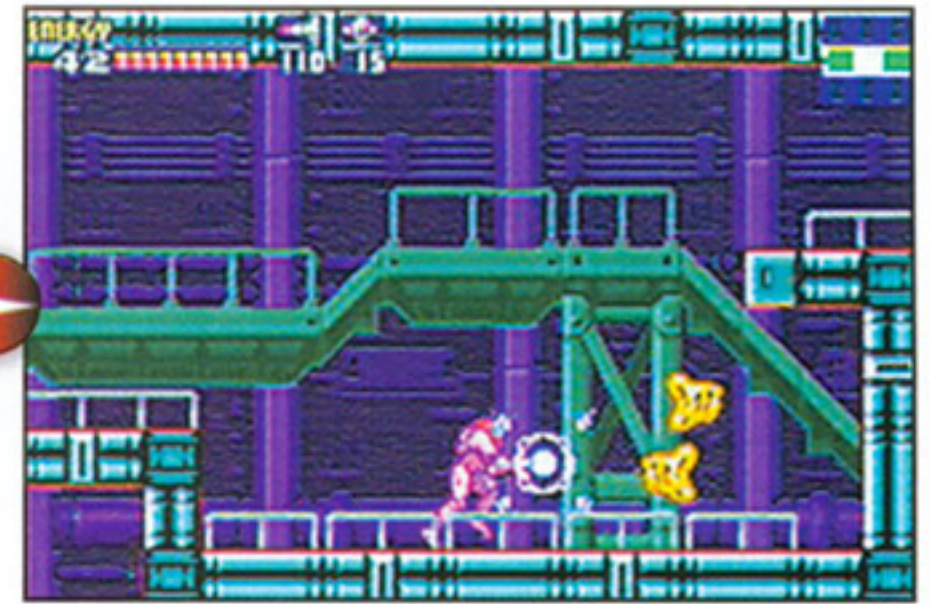

Your prize for defeating each pirate is a pair of powerful parasites.

9 EVADE AND ATTACK

After you collect an Energy Tank and as you begin to close in on the target area, you'll continue to fight Space Pirates. When you take on a pirate that is at your level, you'll have to practice evasive action as you charge and release Beam shots. Jump to avoid the low shots and crouch to avoid the high shots. Don't worry if you lose a little energy while you battle the pirates. You'll collect a tank-filling red X parasite before you face the area boss.

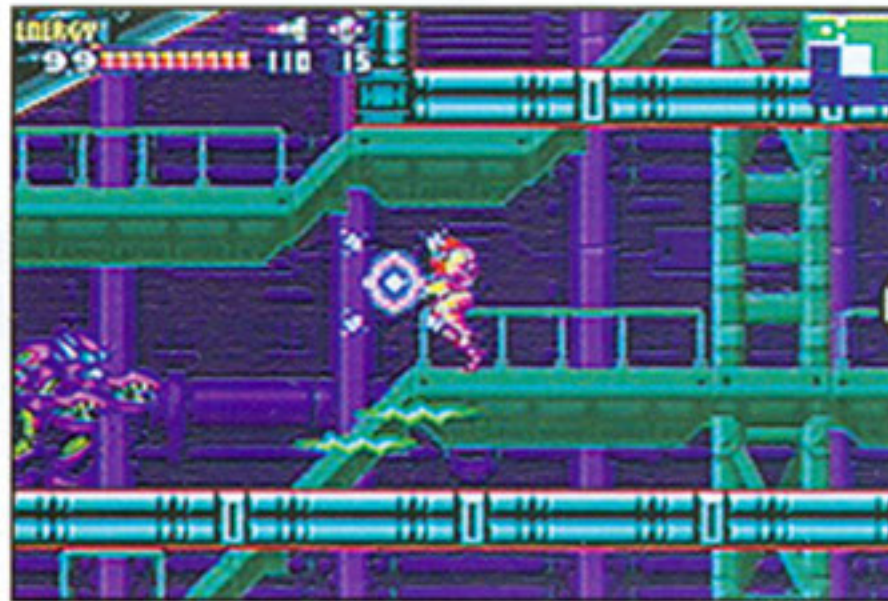

Jump or crouch out of the way when the Space Pirates fire at you.

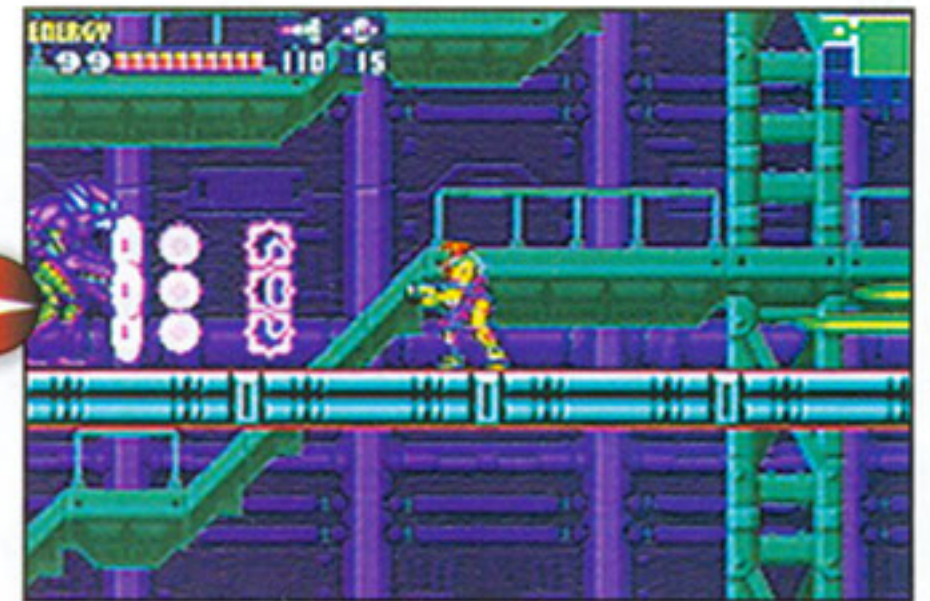

Counter their shots with your own Charge Beam shots or pummel them with Missiles.

10 BOSS BATTLE

The Reactor Core spider is one tough opponent. If the spider grabs you as it skitters back and forth in the arena, it will sap your energy then throw you down hard to

the ground. Avoid the arachnid's grasp and fire Missiles at its mouth when it stops to charge up for a flame attack. After the creature loses its legs, stand in a corner of

the room and fire Charge Beam shots or Missiles to keep it from closing in on you.



You'll have good luck in avoiding the spider's grasp if you roll into a corner.



Hit the boss's open mouth with Missiles. When its legs are gone, stay in a corner and hit it with more Missiles or Charge Beam shots. Your reward is the Space Jump.

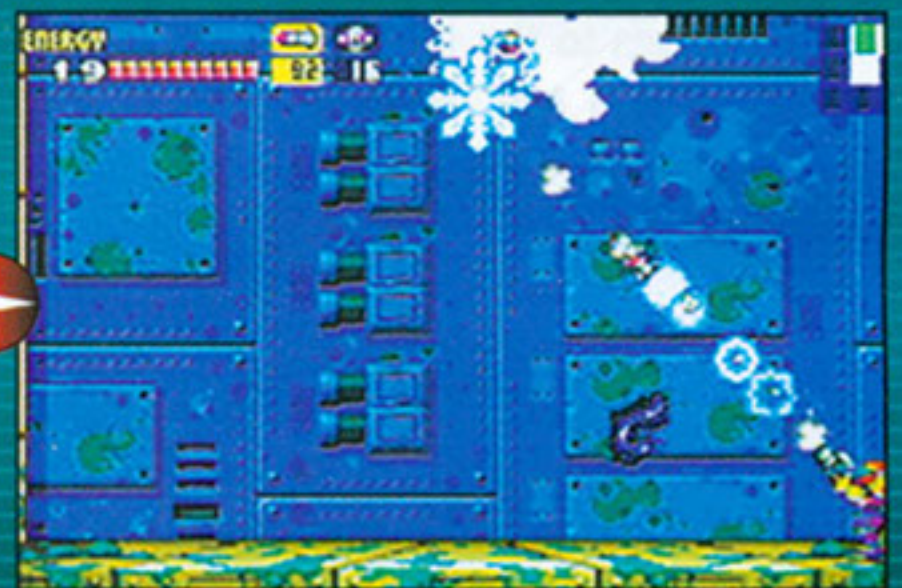

THIRD OBJECTIVE Find the Auxiliary Power Station.**II POWER ON**

After you defeat the spider, and the Core-X that follows, you'll earn the awesome Space Jump ability. The Space Jump allows you to stay in the air as long as you continue to press the A Button at the right time. Space Jump timing takes some getting used to—you'll perfect it with practice. Use the Space Jump to enter a passage in the upper-left section of the boss arena and follow the passage to the Auxiliary Power Station.

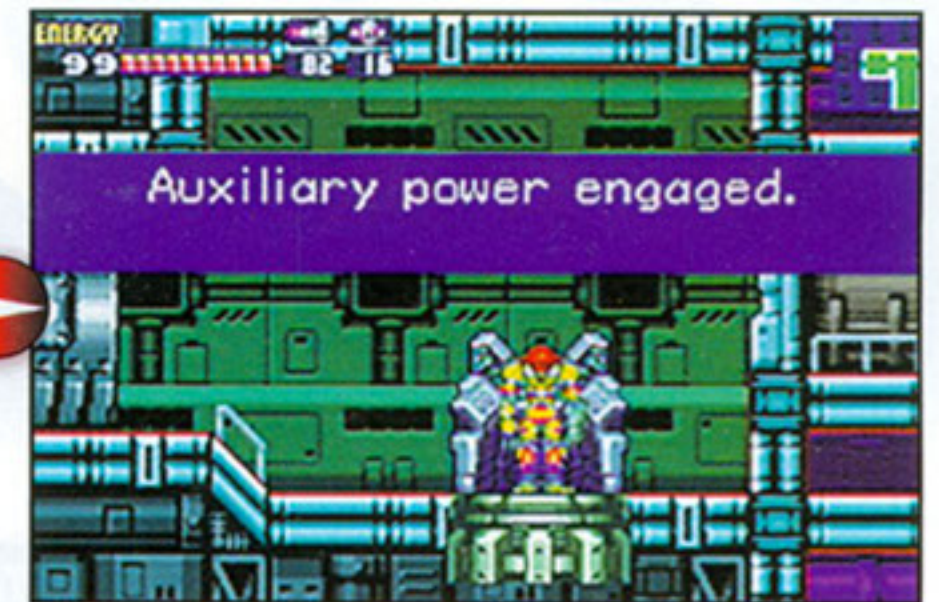
**FOURTH OBJECTIVE** Proceed to the Navigation Room.**12 THE ROOT OF THE PROBLEM**

The auxiliary power will be on, but hatches and elevators will still be out. You'll have to restore the main reactor silo before all systems will be back in working order. The main cause of the problem appears to be parasite-controlled vegetation. When you reach the Navigation Room, the computer will tell you to seek out and destroy the source of the vegetation, but it won't give you a target location. Head off into uncharted territory.



The computer will give you the lowdown on the reason that the power is out.



After you leave the Navigation Room in search of the vegetation source, open a shutter and go.

FIFTH OBJECTIVE Investigate the source of the vegetation problem.**13 SECTOR 2 SHORTCUT**

The main source of the vegetation problem is in Sector 2. Since the elevators are out, you'll have to find an alternate route to the area. You'll discover a shortcut passage in the upper-left section of the Reactor Core. You

can reach the narrow passage by using your Space Jump ability, but you'll be able to enter the passage only once you've cleared away a collection of roots. The journey through Sector 2 will be challenging—starting with an

encounter with the SA-X. Before you enter the shortcut passage, you'll serve your mission well by returning to the ship to refill all tanks and save game data. Then go back to the reactor and continue your journey.

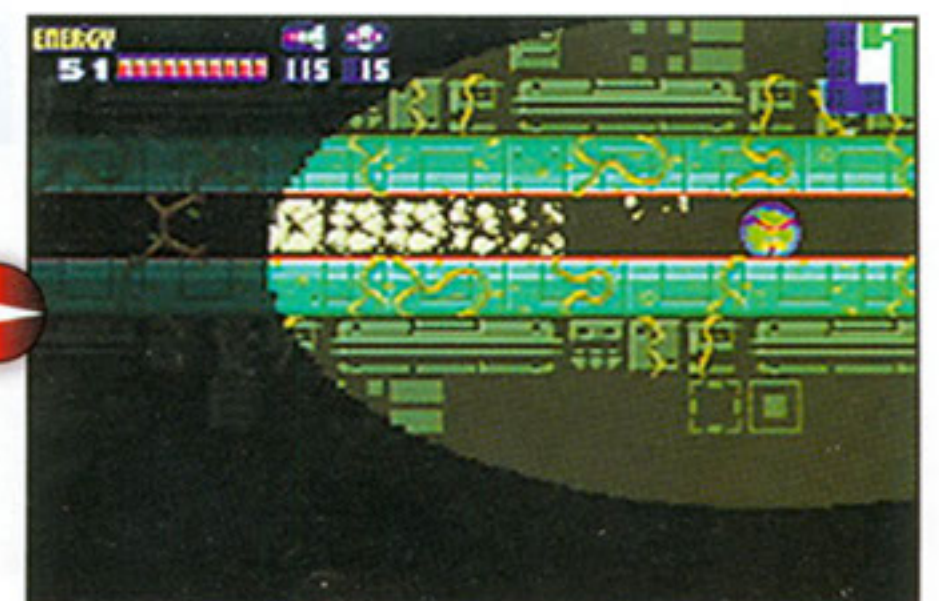

SECTOR 2

TRO

With the elevator out, you'll take an alternate route to—and through—Sector 2. Be prepared. Early on, you'll spar with the deadly SA-X.

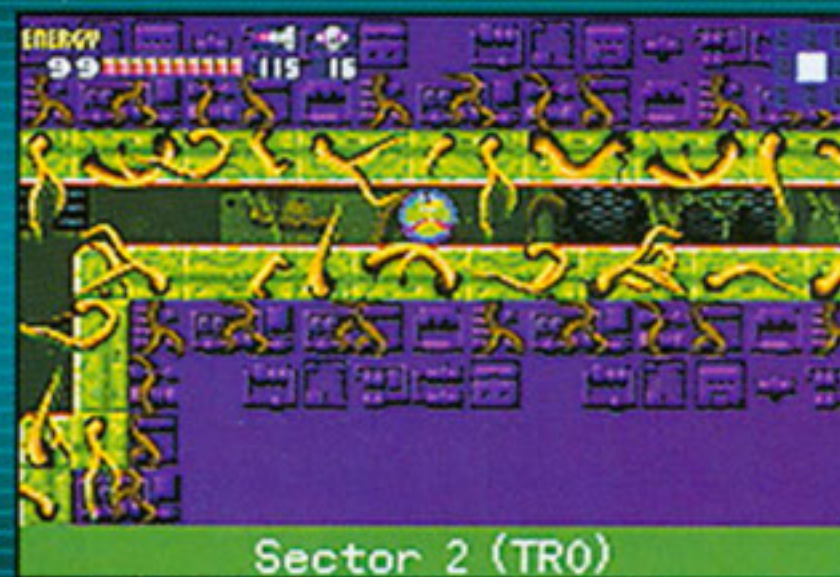

To SECTOR 5
PG. 80

6 PG. 79

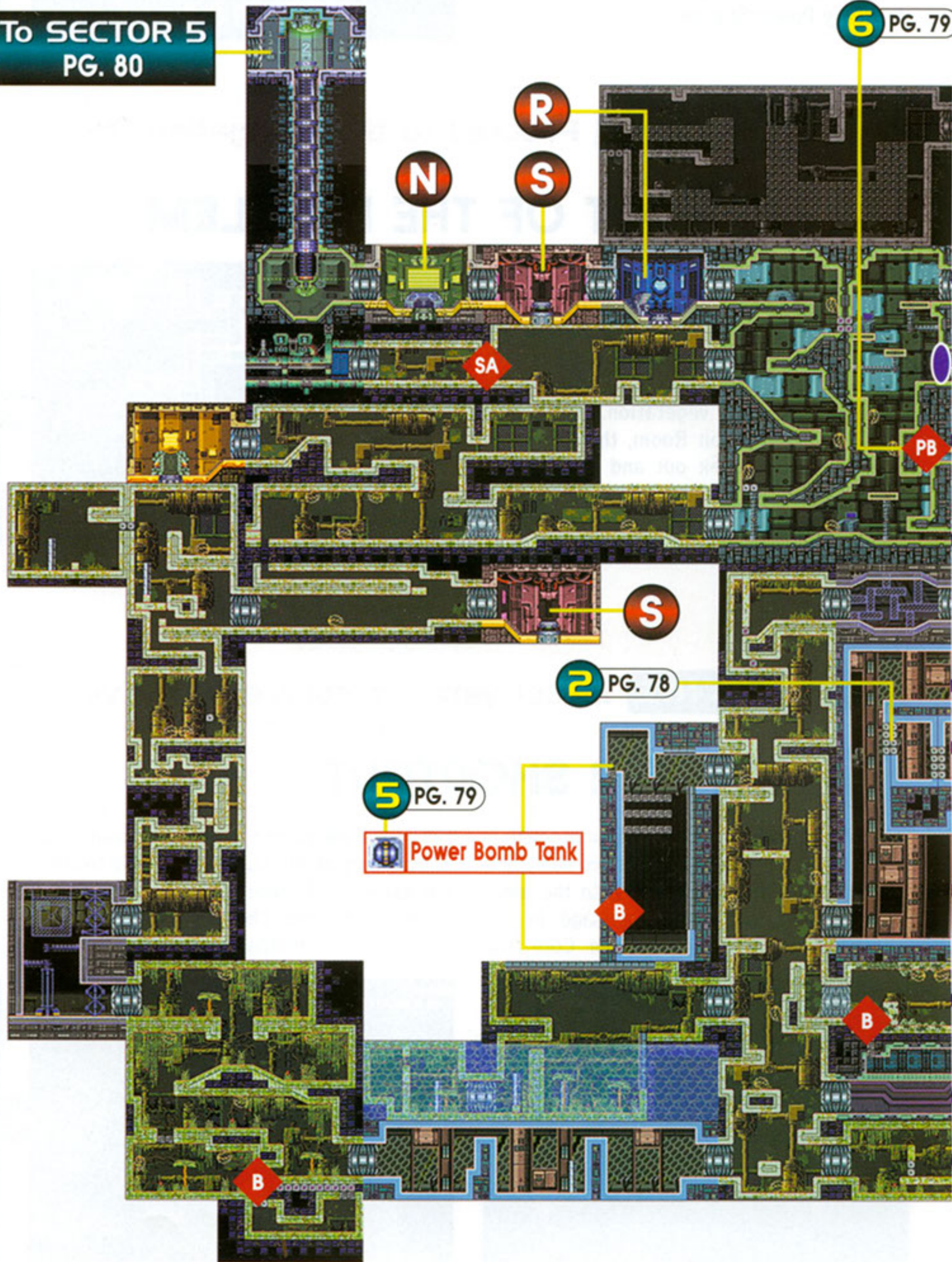

FIRST OBJECTIVE Investigate the source of the vegetation problem.

1 RUN FROM TROUBLE

Your first enemy encounter in the Sector 2 shortcut will be a terrifying SA-X battle. You won't be equipped to defeat the perfect copy of Samus Aran—all you can do is freeze it with Ice Missiles and run away. The creature will catch up to you in a room

that has a weak wall. Freeze the SA-X, then destroy the wall with a Bomb. As you run through the passage to the left, you'll jump over roots and open shutters with the enemy hot on your heels. At the end of the path, you'll reach a computer room with a

tall wall on its left side. Climb over the wall and wait. When the SA-X reaches the room, it will stop then turn around to look for you elsewhere. After the enemy leaves, return to the shutter area and open a passage in the ground by using Missiles.



The SA-X is much too powerful for you to defeat. Run away and avoid its beam.

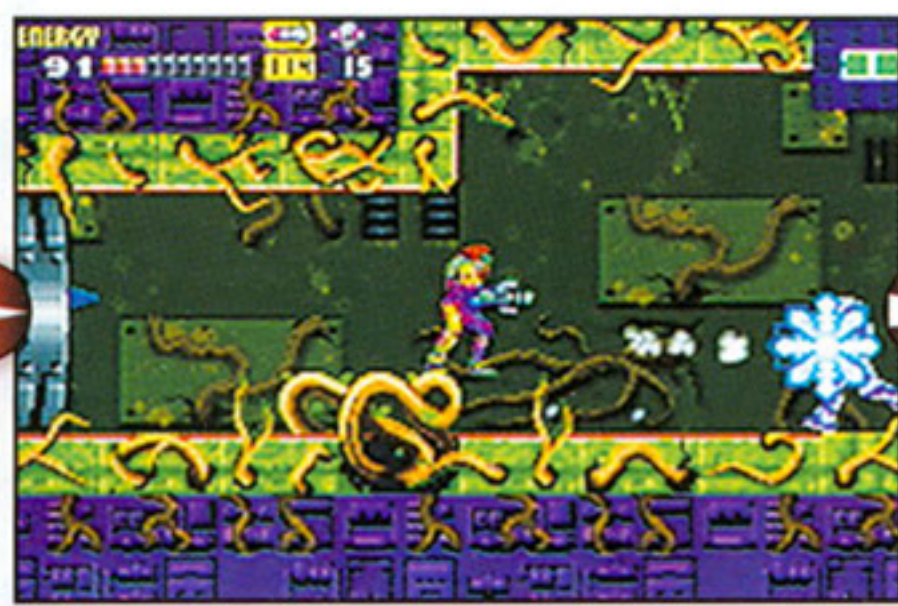

Freeze the creature with an Ice Missile when you have a clean shot.

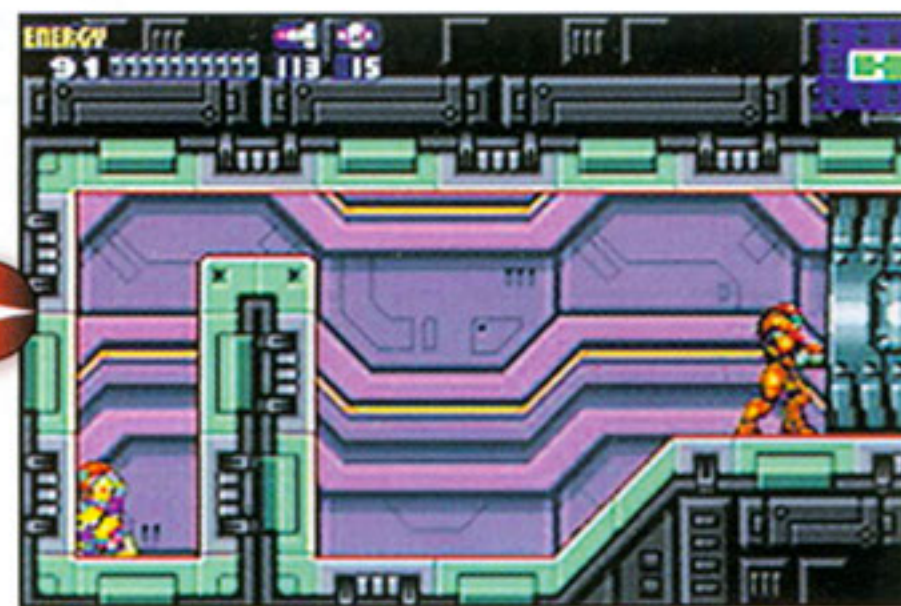

Hide from the villain behind a wall. Wait for it to leave, then look for a new passage in the next room.

2 FLY AND DESTROY

You'll use the Power Bomb and Space Jump abilities extensively to reach previously unexplored sections of Sector 2. Use Power Bombs to destroy enemies and obstacles, and use the Space Jump to fly high into tall areas. When you reach the room with blue walls, Space-Jump up a vertical section and destroy a section of the wall, just below the upper-left ledge. Fly through the hole and follow the path to a Power Bomb Tank.

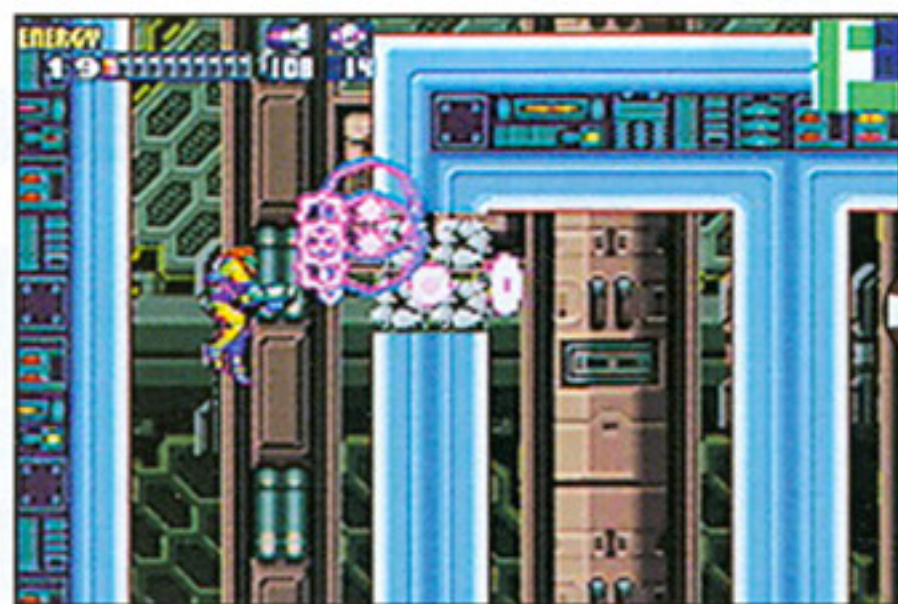

Fly up a long, vertical section with the Space Jump and blast through the upper-left corner of the wall.

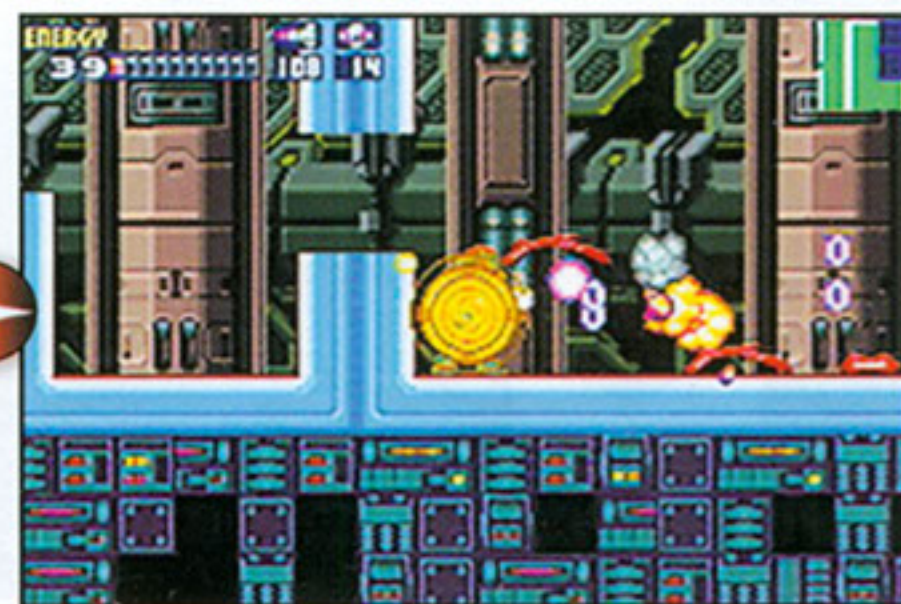

Defeat the enemies in the area, collect a tank, then climb up and around to a Save Room.

3 POWER THROUGH TO THE BOSS

The area boss is not far from the Save Room. Run to the right into a room with a low ceiling. Fire straight up through a series of ceiling blocks and Space-Jump to an area where an enemy is caught in a tangle of roots. Use a Power Bomb to destroy both the roots and the enemy, then Space-Jump up to an eyeball-guarded hatch. Defeat the eye with a Missile, collect a red parasite and get ready for a fight.

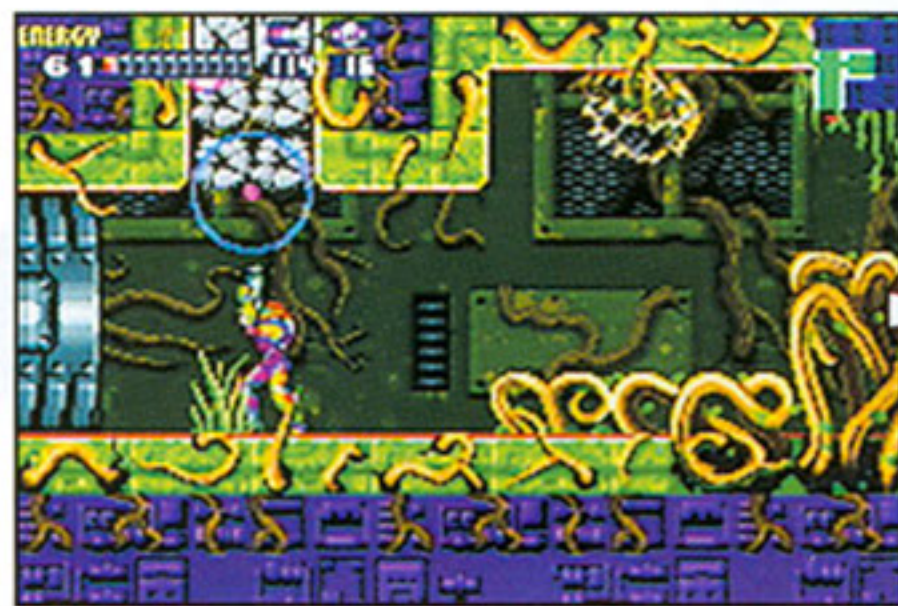

Fire straight up to destroy blocks in the ceiling, then Space-Jump up through the vertical passage.

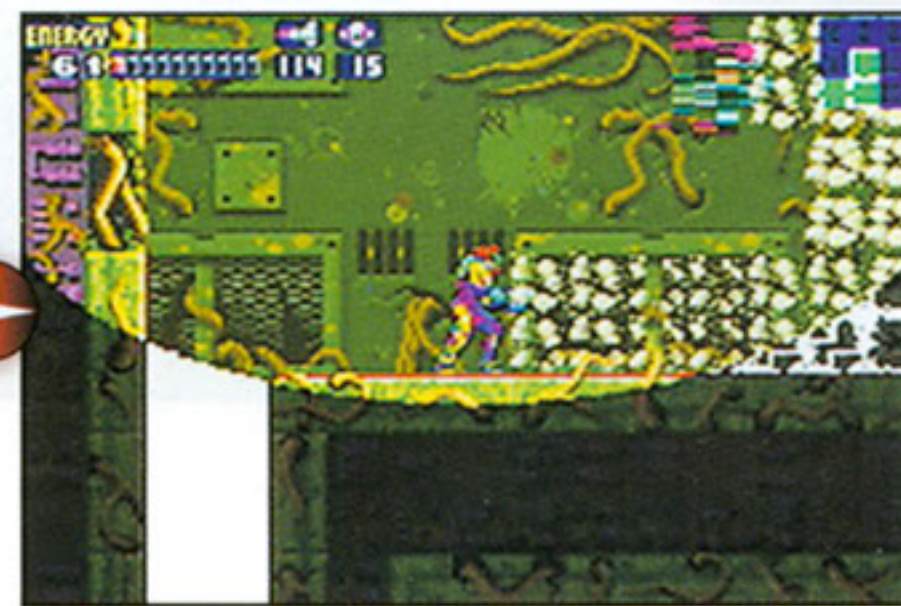

Blast the roots and the enemy caught in the roots with one Power Bomb blast.

4 BOSS BATTLE

Hanging plants fire projectiles that aim to knock you into adventurer-eating flowers in the giant root's arena. Clear away the projectiles with Wide Beam shots or

Power Bomb blasts and hit the root with as many Missiles as you can muster. After you severely damage the root, it will fire lasers. Jump or duck to avoid the shots and

continue to hit the root with Missiles. If you fall into the flowers, jump as high as you can to get out of them.



Fire at the projectiles from the hanging plants with your Wide Beam or blast them with a Power Bomb.



After the giant root takes a lot of damage, it will begin to fire lasers high and low. Eventually, it will take the form of a giant Core-X. Defeat it for the Plasma Beam.



SECOND OBJECTIVE Proceed to the Navigation Room.

5 FREEZE AND ROLL

Returning to familiar Sector 2 territory, you'll have a chance to explore a previously blocked room and discover a Power Bomb Tank. Work your way left along the horizontal ladder on the ceiling and fire a Missile straight down to freeze a hovering creature. Drop onto the creature and freeze the other flying fiend with a diagonal shot. Hop, in ball form, on the second beast then jump to the tank.



Freeze the first hovering creature while hanging from the ceiling. Then drop and aim for the other one.

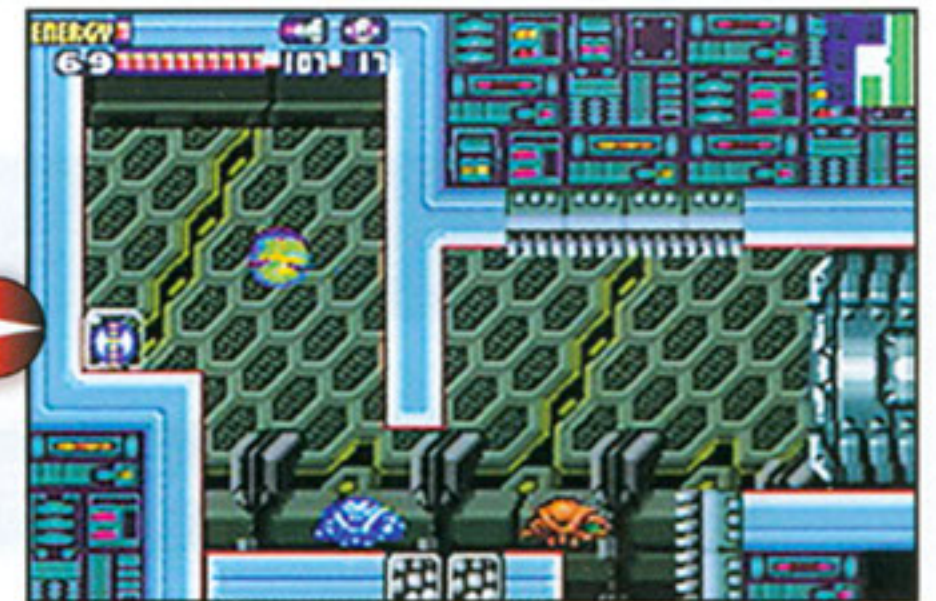

Roll up and hop from one frozen fiend to another, then to the ledge that holds the prize.

6 EXPLOSIVE EXPLORATION

Power Bombs destroy obstacles and help you uncover hidden items. When you use a Power Bomb in the upper-right section of a large, vertical chamber near the Sector 2

entrance, you'll gain access to a small passage that leads to a series of rooms. Run right to what appears to be a dead end and defeat all of the wall-crawling creatures in

the room. When the creatures are gone, run to the right wall, jump and grab onto a hidden ledge. Pull yourself up and roll to the right, into another room.

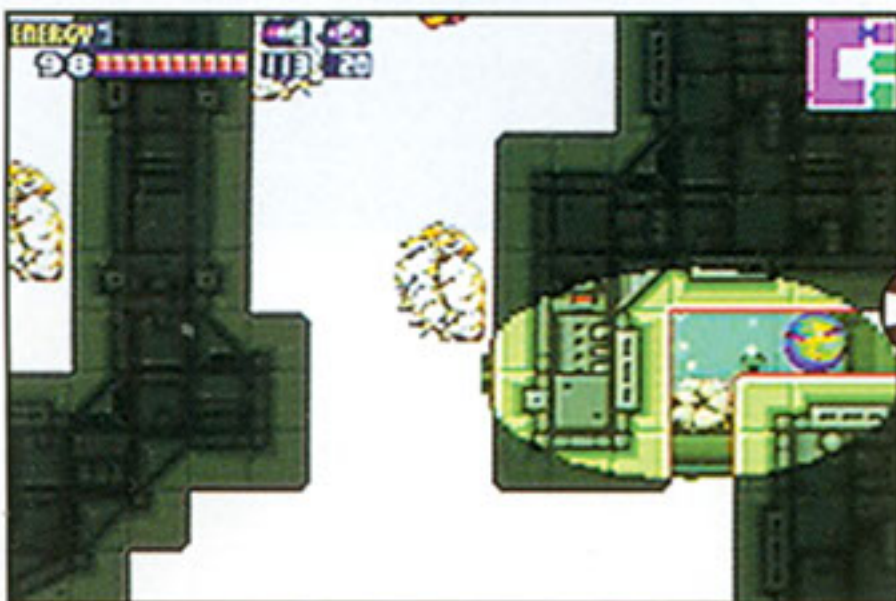

Use a Power Bomb in the upper-right section of the shaft to reveal a passage.



Defeat all of the enemies in the next room and jump up to a covered tunnel in the wall.



You'll make your way to one of the game's 20 Energy Tanks.

SECTOR 5

ARC

An explosion in Sector 5 has made the arctic habitat unstable. The computer believes that an experimental bio-mechanical beast is the source of the trouble.



START

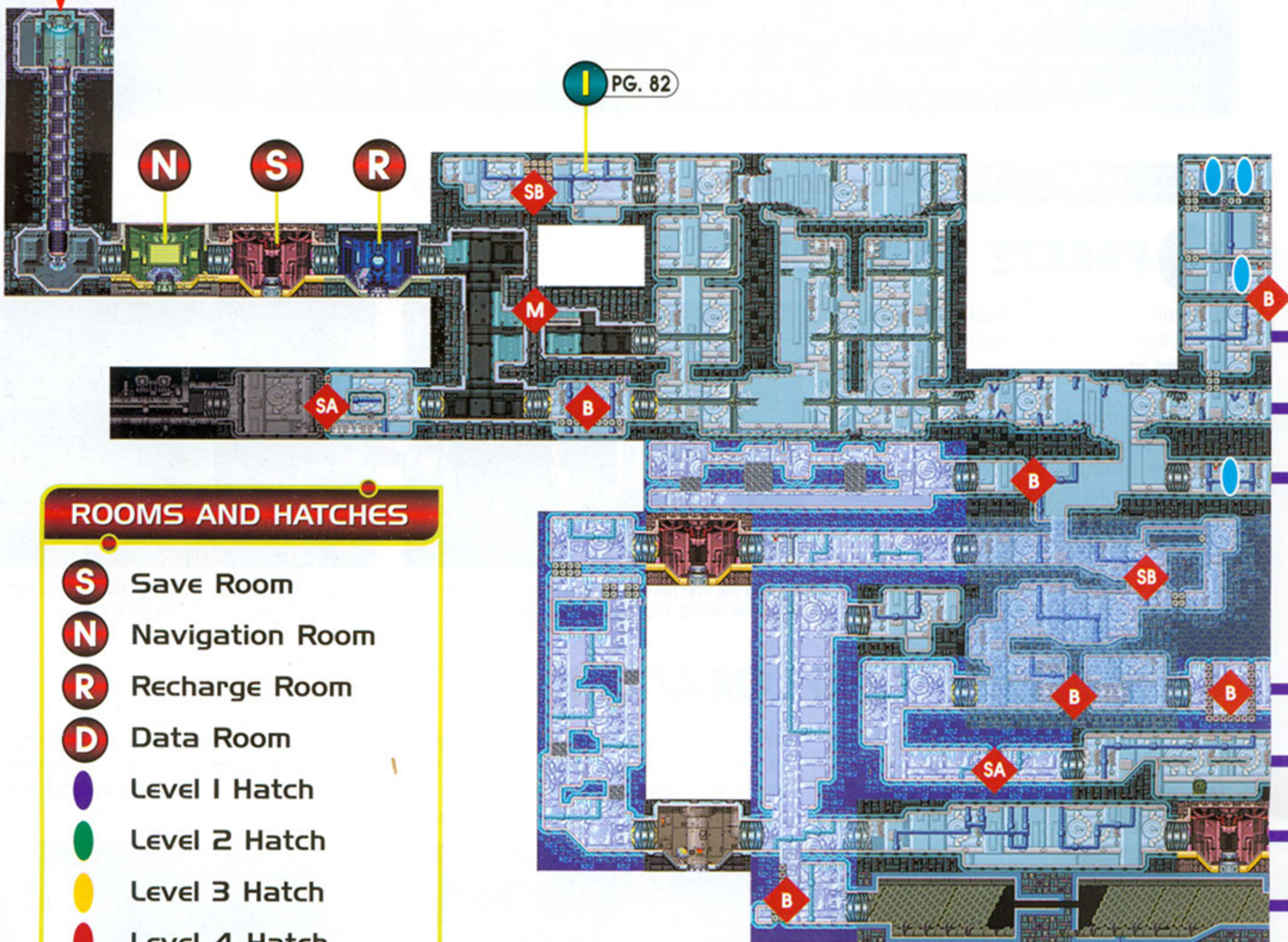

ROOMS AND HATCHES

- S** Save Room
- N** Navigation Room
- R** Recharge Room
- D** Data Room
- Level 1 Hatch
- Level 2 Hatch
- Level 3 Hatch
- Level 4 Hatch
- Special Hatch
- Shutter

BLOCKS

- B** Bomb Block
- PB** Power Bomb Block
- M** Missile Block
- SB** Boost Block
- SA** Screw Attack Block

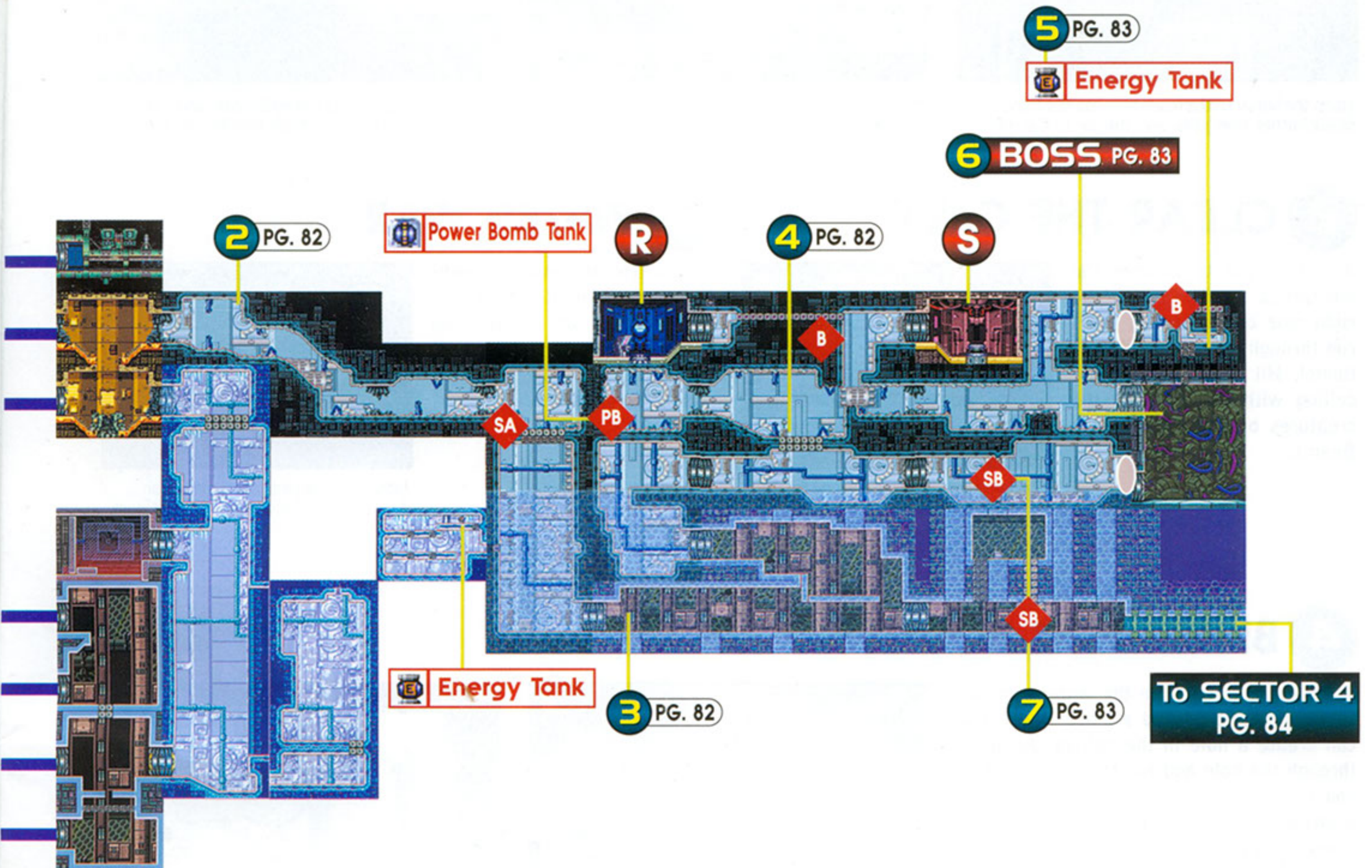

FIRST OBJECTIVE Track down the "Nightmare" organism.

1 ROCKET-POWERED RUN

The room in the upper-left corner of the mapped-out section of Sector 5 may still have a Missile Tank, unless you picked it up in an earlier trip to the area. It also has a left wall made of Boost Blocks. Leave the room, turn to the left and open the hatch.



Open the hatch to the room that has the Boost Block barrier, then jump over the gap to the right.

Then turn back to the right, jump over the gap and run, clearing the area of enemies along the way. When you reach the end of the passage, stop, turn to the left and run again. Your Speed Booster will charge up before you reach the gap. Crouch to stop

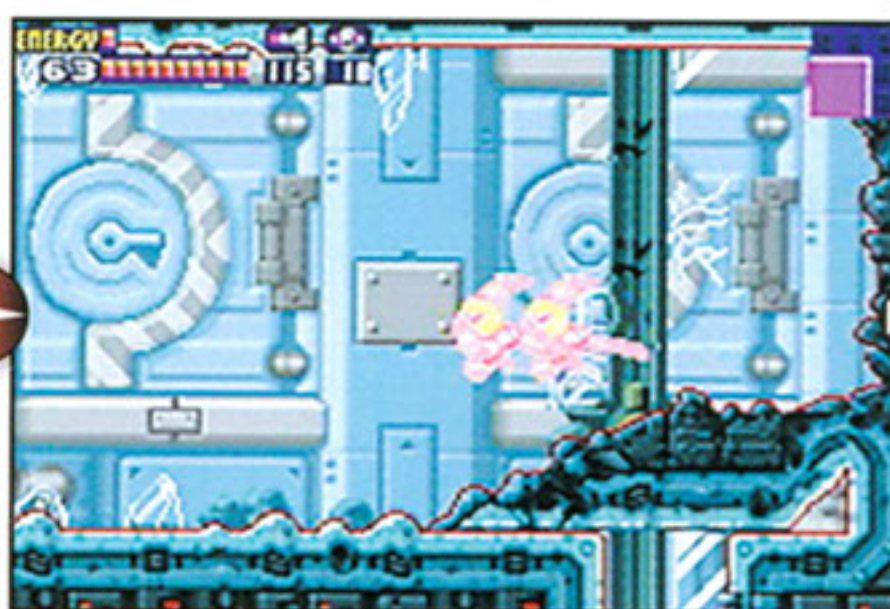

Build up your Speed Booster on the right side of the passage, then run to the left.

running in your charged state, jump over the gap, enter the room that has the Boost Blocks. Press the A Button, then press Left on the Control Pad. You'll launch to the left and blast through the barrier, into an area where you will find a Power Bomb Tank.

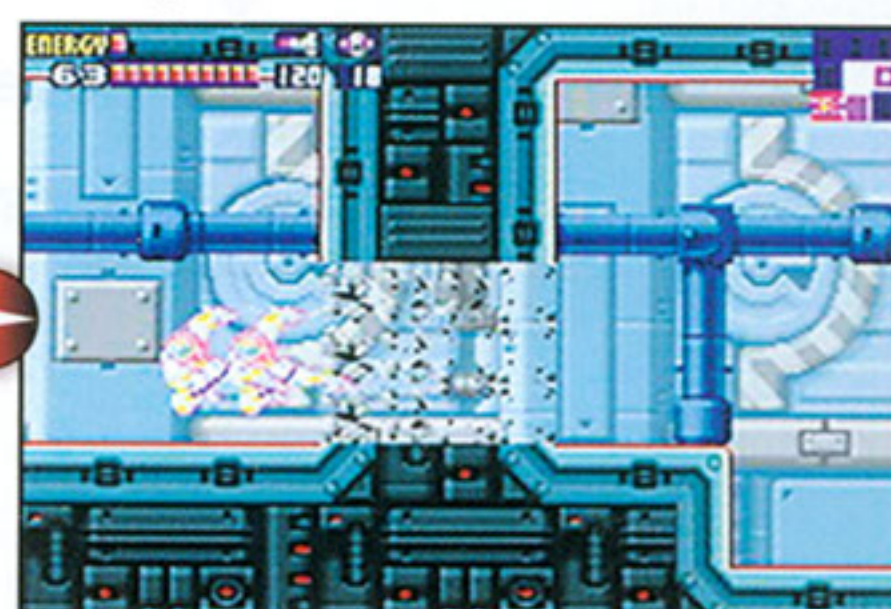

Run left to charge your Speed Booster and crouch to stop. Enter the room and blast through the barrier.

2 CLEAR THE CAVE

As you begin to explore the uncharted territory on the right side of the sector, you'll run through an enemy-infested tunnel. Hit the beasts on the ceiling with Missiles and the creatures on the ground with Beams.



The large creatures on the ceiling are no match for your Missiles.

3 WATER WAR

As you troll the watery depths of the sector, you'll come across a collection of beam-firing Zebesian Space Pirates. Charge up your Plasma Beam and let them have it.



Introduce the pirates on the ocean floor to your charged-up Plasma Beam.

4 BLAST FOR BOUNTY

After you emerge from the water and run to the right, you'll find a place where you can create a hole in the ceiling. Jump up through the hole and run to the left. When you reach the room that is full of wall-crawling creatures, detonate a Power Bomb. You'll defeat all of the creatures and reveal a Power Bomb Tank.



Fire at the ceiling to open a hole to an area up above, then jump up and run to the left.



Detonate a Power Bomb in the enemy-infested room and collect a Power Bomb Tank.

5 PATH TO POWER

Once you Space-Jump up to an eye-guarded hatch and destroy the eye with a Missile, collect the red X parasite and move on to the next room. You'll see an Energy Tank at the end of a tight tunnel. If you roll into the tunnel, you'll fall through the floor before you reach the tank then drop into the boss arena. Use a Power Bomb to reveal a different path to the tank, then jump, in ball form, up to the new passage and collect the tank.



Hit the eye with a Missile, then collect the X parasite to fill your tanks.



Before you drop into the boss arena, use a Power Bomb to reveal a path to the Energy Tank.

6 BOSS BATTLE

The biomechanical beast that protects the Gravity Suit really is a Nightmare. Jump up to make the enemy float to the top of the arena, then drop and hit its red, glow-



Draw the enemy up the top of the arena, then drop and hit the power source.

ing power source with Missiles or a charged Plasma Beam. After you destroy the power source, the creature's face will turn red. Jump to the ladder on the left



After you destroy the power source with charged shots or Missiles, aim for the head of the creature with a Missile barrage.

wall and pummel the creature's head with Missiles. Space-Jump to avoid attacks, then fight back with more Missiles.



SECOND OBJECTIVE Proceed to Sector 4.

7 RUN IN WATER

Your prize for defeating the Nightmare, and the Core-X that follows, is the Gravity Suit upgrade. The new suit data will give you more protection and allow you more mobility in water and lava. With the Gravity Suit,

you can even activate the Space Jump and Speed Booster in flooded areas. You'll test that suit attribute immediately after your fight with the boss. There is a Boost Block barrier in the next room. Move to the right

side of the boss arena, then turn, run left, fire at the hatch and run into the next room. Your Speed Booster will charge as you approach the barrier, and you will speed through it.



SECTOR 4

AQA

By using your newfound underwater mobility, you can run through a Boost Block barrier in Sector 5 and break into Sector 4. Continue your journey in the water world.

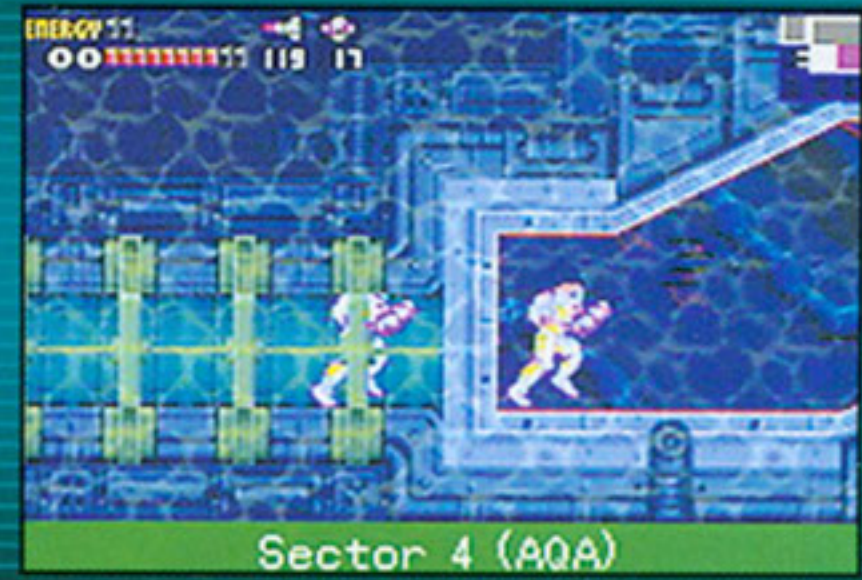

BLOCKS

- B** Bomb Block
- PB** Power Bomb Block
- M** Missile Block
- SB** Boost Block
- SA** Screw Attack Block

ROOMS AND HATCHES

- S** Save Room
- N** Navigation Room
- R** Recharge Room
- D** Data Room
- Level 1 Hatch
- Level 2 Hatch
- Level 3 Hatch
- Level 4 Hatch
- Special Hatch
- Shutter

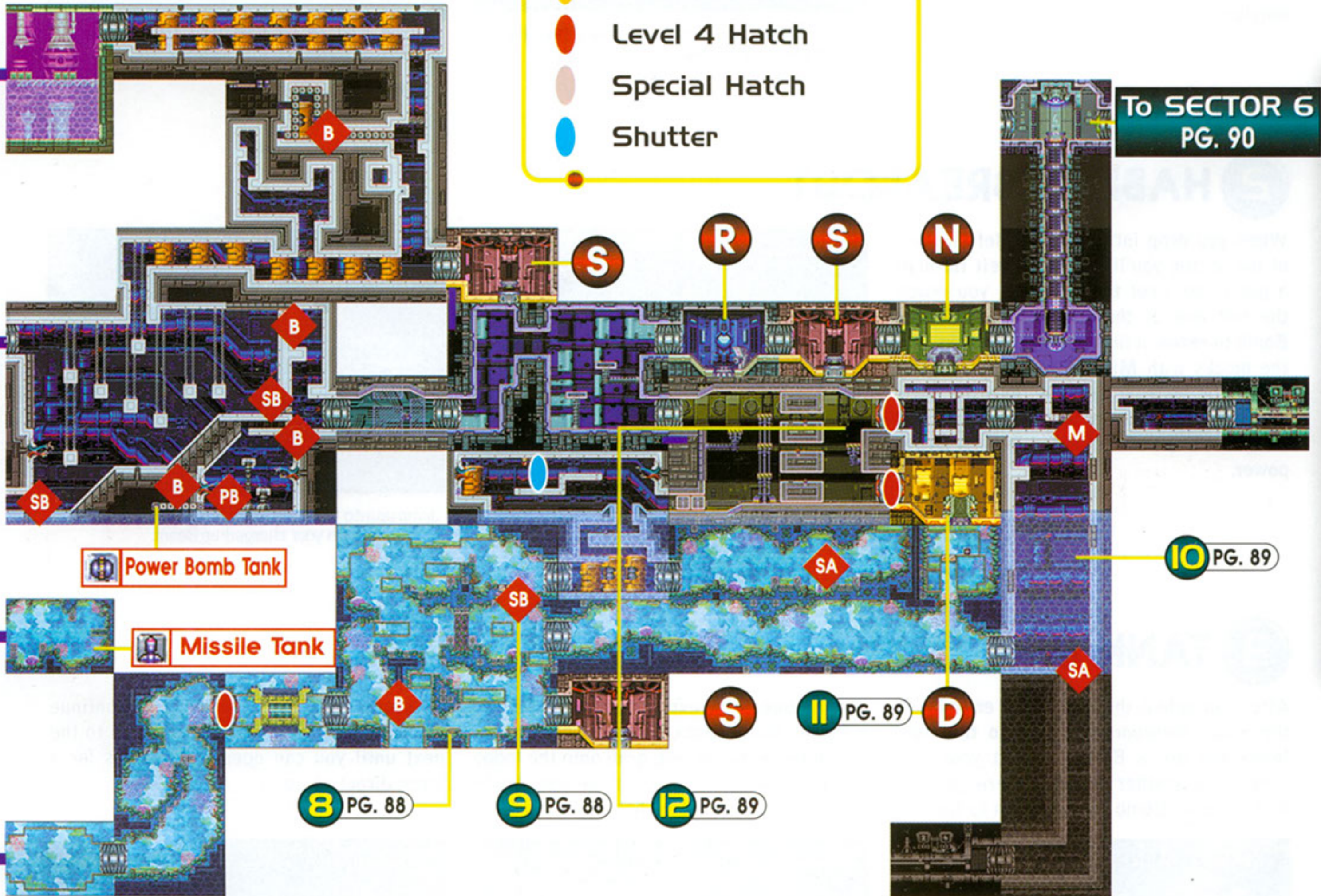

To SECTOR 6
PG. 90

10 PG. 89

11 PG. 89

8 PG. 88

9 PG. 88

12 PG. 89

FIRST OBJECTIVE Explore Sector 4.

1 HIGH-SPEED COLLISION

You'll discover that the upper half of the wall on the other side of a gap is made of Boost Blocks. Return to the entrance to Sector 4, then turn to the right and run up the path to the gap. When your Speed Booster charges, either jump through the obstacle or crouch to stop. If you stop, press the A Button, then press and hold Up and Right on the Control Pad. You'll launch over the gap and rocket through the Boost Block barrier.



Run up the path and charge your Speed Booster. When you reach the top, crouch to stop.



Press A, then press and hold Up and Right to blast off into the barrier.

2 HABITAT BREAKOUT

When you drop into the lower-left section of the sector, you'll run to the left through a glass and steel tunnel. When you reach the left end of the tunnel, use a Power Bomb to reveal a line of Missile Blocks. Hit the blocks with Missiles to create a hole, then jump through the hole, into the open water. You'll encounter water enemies right away. Hit them with charged Plasma Beam power.



Use a Power Bomb to reveal Missile Blocks then break through them with Missiles.



Jump up into the open water and blast the water creatures with your charged-up Beam.

3 TANK UP

After you defeat the first set of enemies in the water environment, jump to the right ledge and use a Bomb to blast your way through to another section, where you will find a Power Bomb Tank. Return to the left

and use one of the explosive tools to destroy a Power Bomb Block in the upper-left corner. Jump up to the left, grab onto the ledge and pull yourself up to the next area. You'll discover that the water habitat is made up

of several connected corrals. You'll continue to move from one sectioned-off area to the next until you can open red hatches for a more direct route.



Jump up to the upper-right corner of the first water section and bomb your way to the right.

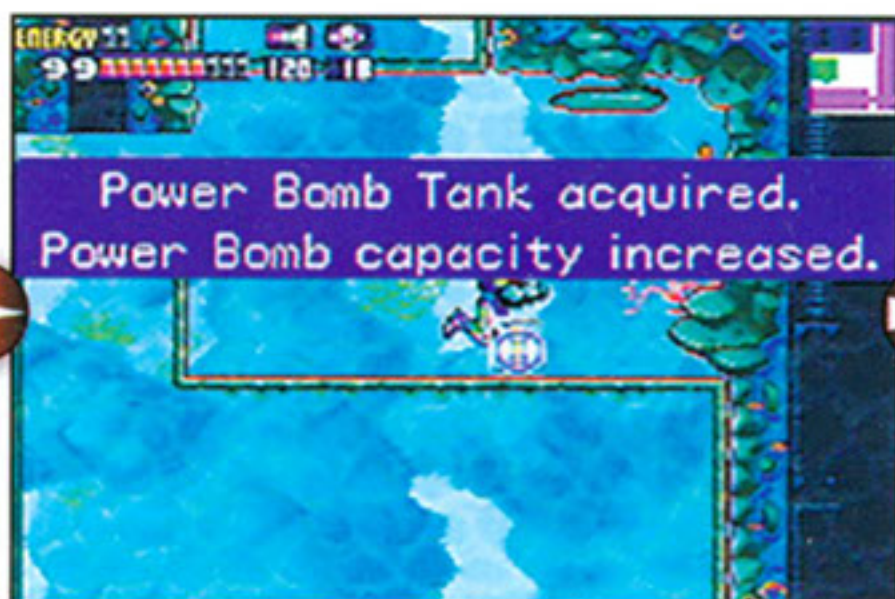

Collect a Power Bomb Tank, then return to the area to the left.



You'll discover a Power Bomb Block. Destroy it with a big blast, then move on.

4 WATERY MAZE

The water habitat is defined by thin walls, Bomb Blocks and natural barriers. You can blast all of the Bomb Blocks with Bombs and roll through some natural barriers, but you can't harm the thin walls. Follow the path shown on the map to the right. Destroy the Bomb Blocks with standard Bombs and fire through the holes in the natural barriers to defeat the enemies before you roll into them. In the lower-left corner, you'll reach a passage to the Security Room.



Fire at the enemies in the area through holes in the natural barriers.



After you deal with the enemies, morph into ball form and roll through the holes.

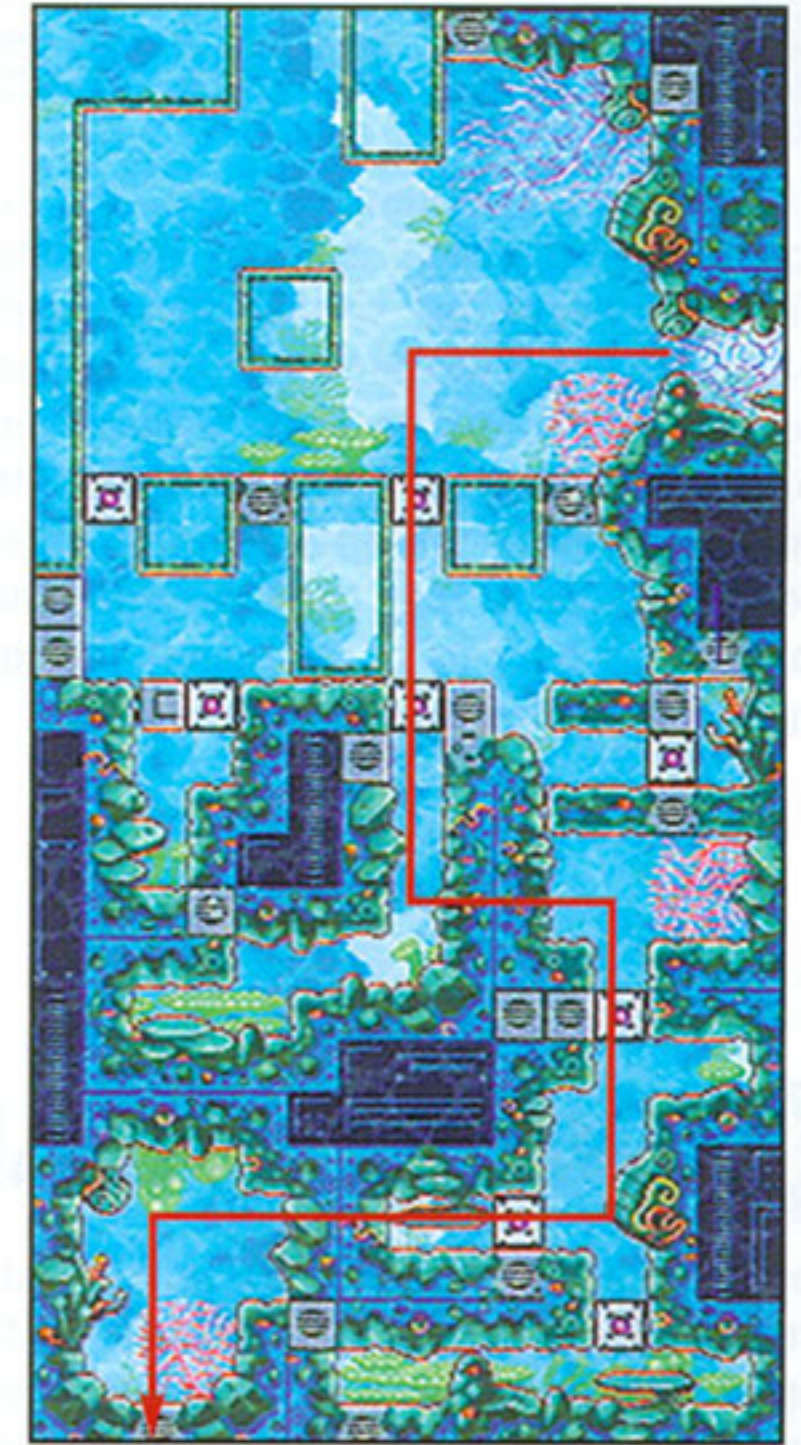

5 UNLOCK RED HATCHES

The water maze will lead you to an unconventional entrance into the Level 4 Security Room. You've seen red hatches in Sector 4—and you can unlock all of them at once. Step onto the Security Room pad and connect with the computer. The computer will confirm a Level 4 breach that will cause the red hatches to flash. Hit the hatch with a Plasma Beam and run through to the next area.



You'll drop into the Security Room from above. Step onto the pad and connect with the computer.



After you unlock the Level 4 hatches, the hatch to the right will flash. Open it.

SECOND OBJECTIVE Download Diffusion Missile data.

6 TANK TOUR

After you leave the Security Room by way of the red hatch, you'll climb up a vertical tunnel. Before you reach the top, stop in an alcove and detonate a Power Bomb to reveal a tunnel to another natural water-and-rock

area. You'll find several enemies in the lower-left corner. Set a Power Bomb, then roll to another area, letting the X parasites that pop out of the creatures re-form into two gold-colored, crablike enemies. You can defeat the

creatures with Missiles or charged Plasma Beam attacks. Once they are gone, the hatch in the lower-right corner will flash. Open the hatch, enter the next area and use a Power Bomb to reveal an Energy Tank.

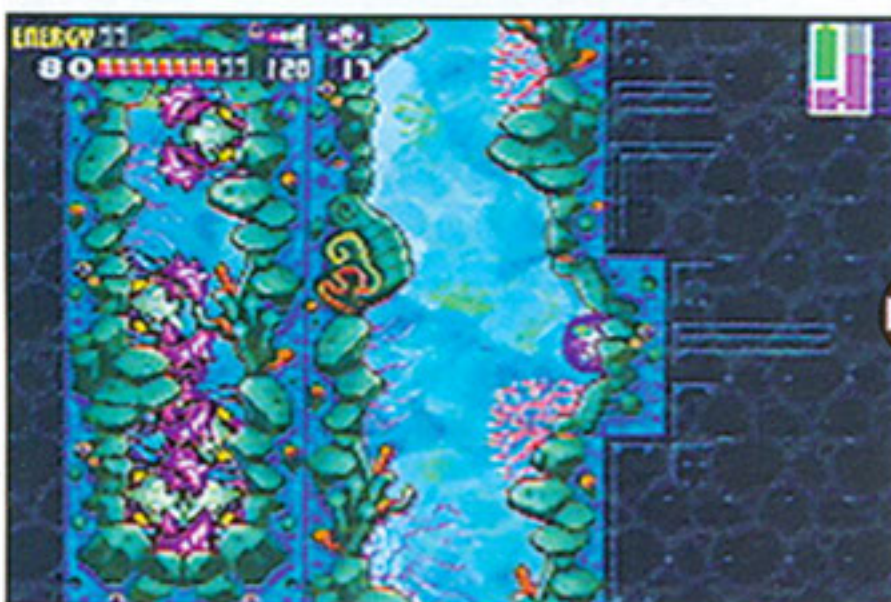

7 FALL THROUGH AND COLLECT

With the Level 4 hatches open, you can move on to the right side of the sector. When you reach the second glass tunnel, detonate a bomb to open a hole in the floor, then drop to a Missile Tank. Several enemies will follow you. After you collect the tank, clear away the enemies and collect their parasites so they can't re-form. Then Space-Jump back up to the tunnel and continue your journey to the right.

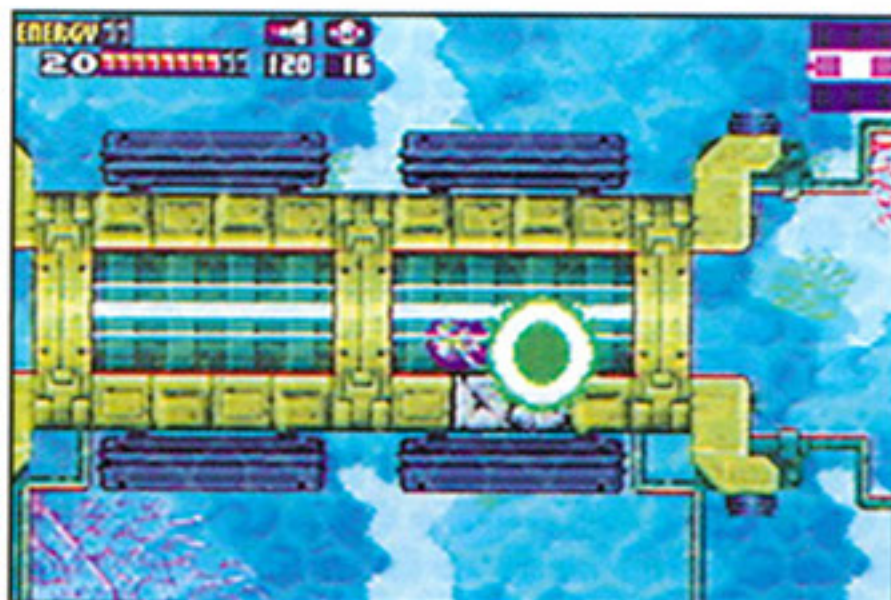

Blast through the floor of the tunnel and drop into a section that holds a Missile Tank.



Defeat all of the enemies in the area, then make your Space Jump escape.

8 WATER HAZARDS

You'll encounter another mazelike water area as you approach the right side of the sector. As before, you can bomb through blocks, but you can't damage the thin walls. The enemies in the area are tough to beat.

You'll have to hit most of them with several charged Plasma Beam shots to defeat them. Some unbeatable creatures inflate as you approach and block narrow passages. Freeze them from a distance while they're

still in their deflated state, then roll past them. The maze is easier to navigate than the other maze area. Make your way up to the upper-right corner, then use a Power Bomb to reveal Boost Blocks on the ground.



Destroy the blocks with Bombs, then roll through the holes.



Freeze an inflatable enemy with an Ice Missile before it puffs up.



Roll into a Morph Ball and hop over the frozen creature before it thaws.

9 BOOST BREAK

After you reach the upper-right corner of the maze area, run to the right through two hatches. Defeat the enemies in the area, then turn to the left and run, opening hatches as you go. By the time you return to the maze area, your Speed Booster will be charged up. You'll burn through the Boost Blocks on the ground then fall through to another hatch.



Run two rooms to the right of the maze, then turn to the left and run without stopping.



When you get back to the maze, your Speed Booster will charge and you'll fall through the floor.

10 FREEZE FORM

The long, vertical passage on the right side of the sector is populated by inflatable enemies. Freeze the enemies, then use them as platforms up to the top. When you reach the

ladder in the upper-right section, freeze the closest enemy, hop onto it and fire Missiles straight up at two Missile Blocks. Then use your Space Jump ability to fly up through

the new hole and grab onto the ledge. Pull yourself up and roll left, to a part of Sector 4 that you have previously explored. You are on your way to the Diffusion Missile data.



Freeze the inflated enemies in the long shaft and use them as platforms.



Rest on the ladders, then fire on the nearby enemies with Missiles.

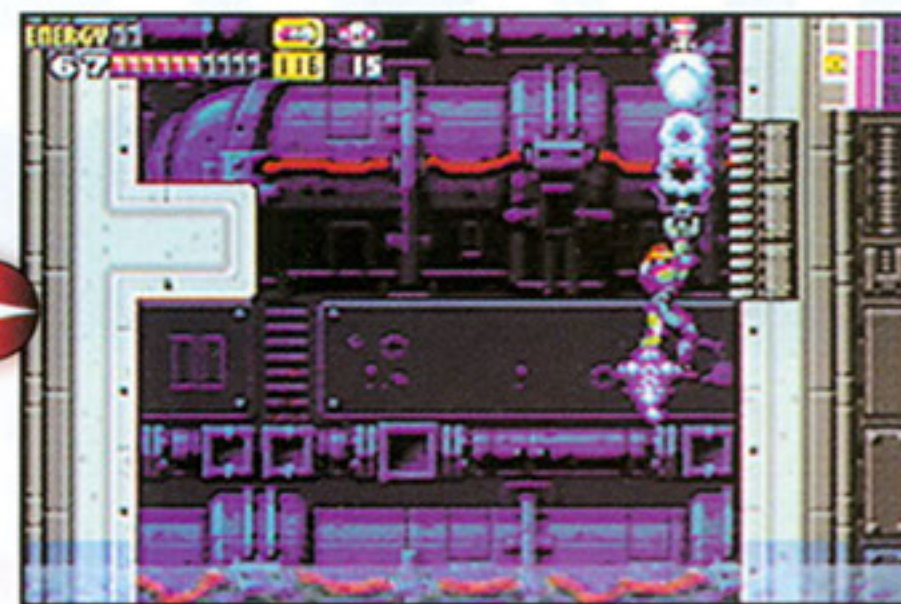

When you get to the upper-right area, stand on a frozen enemy and break blocks using Missiles.

11 DIFFUSION DELIVERY

The Data Room in the right section of Sector 4 holds Diffusion Missile data. Press and hold the R Button to charge up your Missiles, then press B to launch. When the Diffusion Missile hits its target, its blast will radiate and affect every target in the area. You could use a Diffusion Missile to destroy two hard-to-reach Missile Blocks in the room where you used frozen enemies as platforms, but you wouldn't get far on that path without the Screw Attack.



Download the Diffusion Missile data in the Sector 4 Data Room.

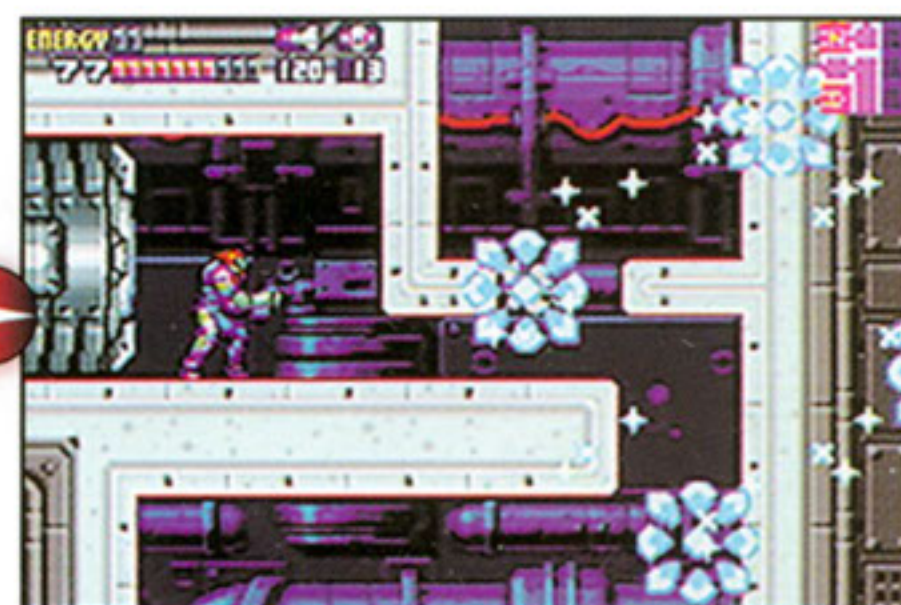

After you have the Screw Attack, you'll use a Diffusion Missile to destroy hard-to-reach blocks.

THIRD OBJECTIVE Proceed to the Navigation Room.

12 FREEZE AND SQUEEZE

Inflatable enemies inhabit several narrow passages that lead to the middle of the sector. The creatures will inflate as you approach them and block you from rolling through the tunnels. Charge up a Diffusion Missile and fire it in the direction of the balloon creatures. The Missile's blast will freeze all of the creatures for a short time. Find a deflated enemy and roll past it, into the left side of the room.

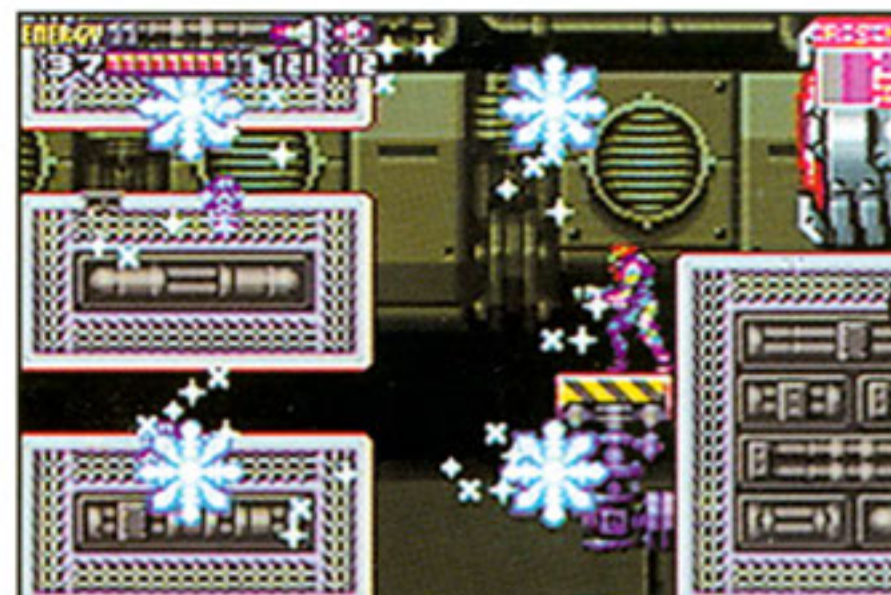

Charge up and fire a Diffusion Missile at the inflatable enemies.

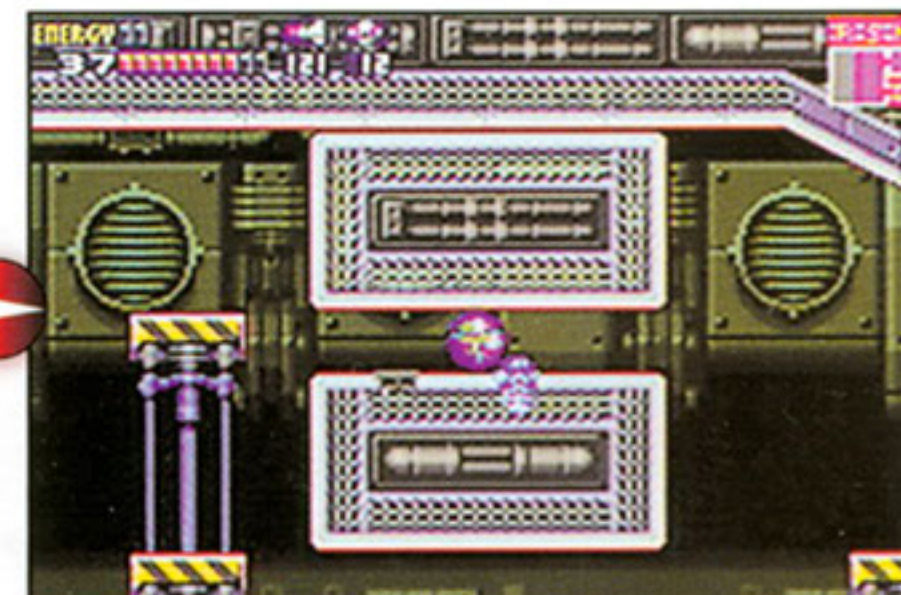

Grab a ledge, pull yourself up and roll through one of the passages, past a frozen enemy.

SECTOR 6

NOC

The security robot that you defeated earlier has been appropriated by the X parasites. You must defeat it then leave the area before the SA-X finds you.

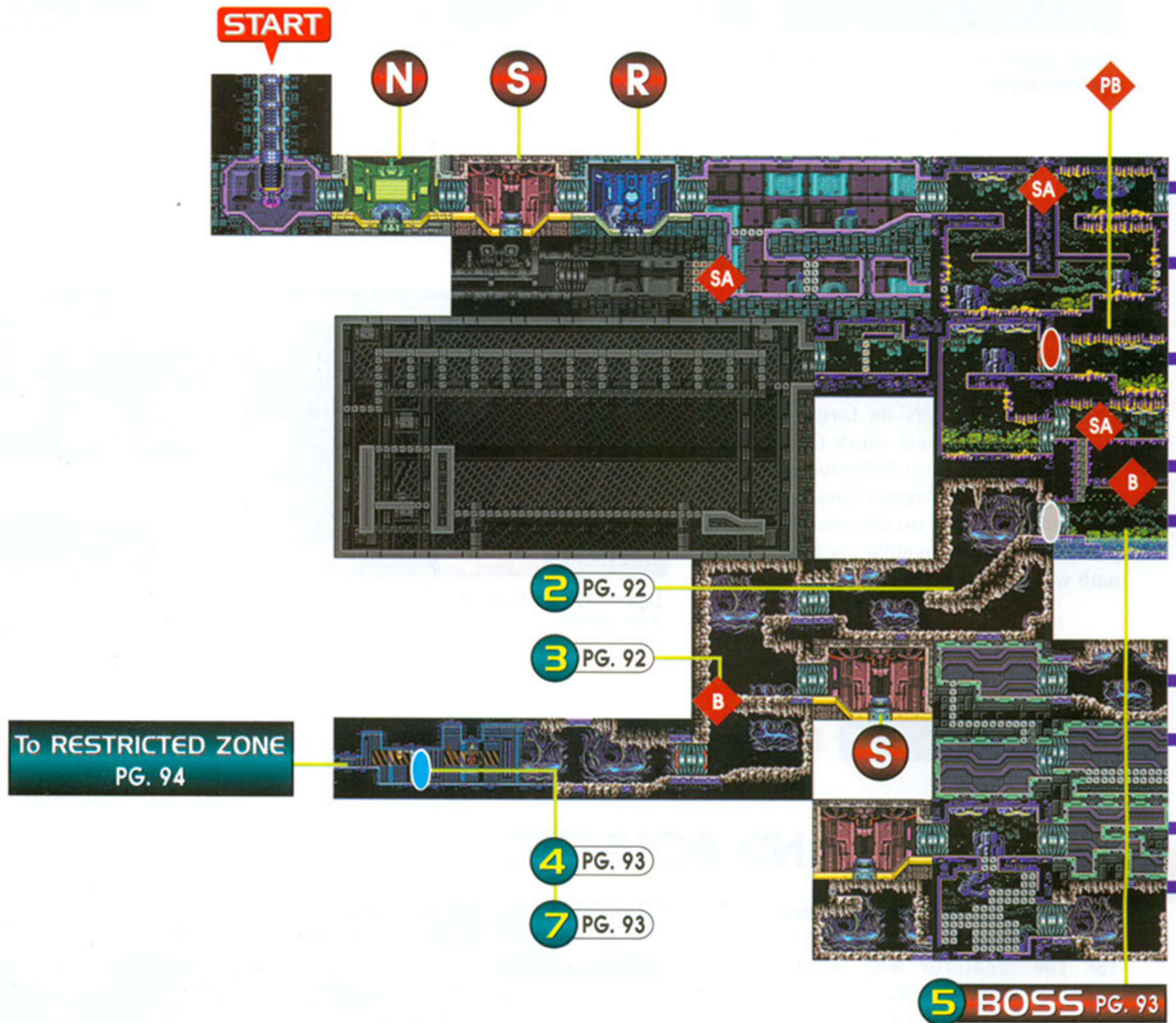

- BLOCKS**
- B** Bomb Block
 - PB** Power Bomb Block
 - M** Missile Block
 - SB** Boost Block
 - SA** Screw Attack Block

- ROOMS AND HATCHES**
- S** Save Room
 - N** Navigation Room
 - R** Recharge Room
 - D** Data Room
 - Level 1 Hatch
 - Level 2 Hatch
 - Level 3 Hatch
 - Level 4 Hatch
 - Special Hatch
 - Shutter

1 PG. 92

6 PG. 93

Missile Tank

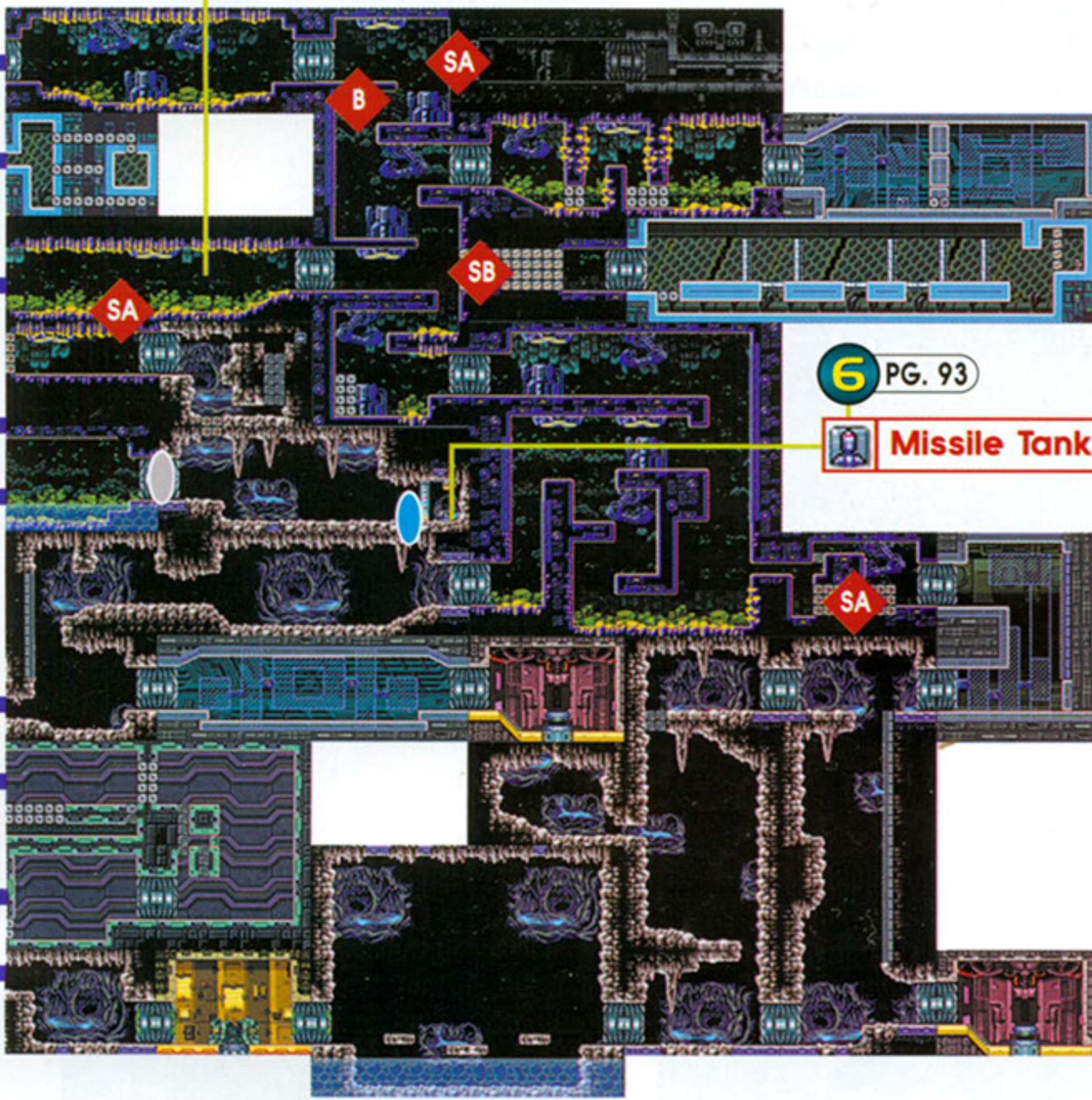

FIRST OBJECTIVE Engage with Security Robot B.O.X.

1 OFF THE BEATEN PATH

You've explored Sector 6 before, but some areas were off limits because you didn't have the right equipment to access them. The path to the Security Robot goes through one such area. Move to the middle of the upper area

to the right, then drop down a long, vertical section and continue to the left. Blast through the Power Bomb Blocks, defeat all of the enemies with rapid Plasma Beam fire and make your way to the red security hatch.

Even if you blasted the Power Bomb Block wall before, you couldn't have passed through the red hatch until you breached Level 4 security. Open the hatch and continue your journey into the unknown.



Your firepower is more than the enemies in the area can take. Hit them all.



When you reach a barrier, set down a Power Bomb and blow it away.



Open the red hatch, then start moving down to the depths of the sector.

2 POISONOUS POP

The parasite-controlled floating spheres contain poisonous gas. When you bust the bubbles, they'll release damaging gas, but it won't travel far. Target the enemies from a distance and let their gas dissipate before you close in on them. Then collect their parasites. Even if you get caught in a gas explosion, you won't lose much energy. Keep moving and clear away the enemies as quickly as you can.



Seek out the floating spheres and target them from a distance. One Plasma Beam shot will do the job.



The enemies will release poisonous gas. As long as you're far away, you won't get hurt.

3 BLAST IT

You've advanced far enough into your Metroid Fusion adventure to know that most barriers are temporary at best. You have a strong arsenal that's getting stronger, and you'll use it to advance through anything. After you save your progress in the lower-left section of the sector, move to the left and use Bombs to blast the metal floor. You could use a Power Bomb to do the job, but it's better to save the strong stuff.



Hit the flying enemies with Plasma Beam firepower and move on to the Save Room.



After you save your progress, place Bombs on the floor and blow open a passage to the next area.

4 GET BACK

When you reach the lower-left section of the sector, you'll find yourself on the wrong side of a one-way shutter and a computer voice will warn you that you cannot enter the next area without authorization. You won't get authorization, but you'll soon earn a weapon that will allow you to open the shutter. Retreat to the area above the Save Room and prepare for a big boss battle.



You can't open the shutter for access to the restricted area—retreat.



On your way back, you'll hear a loud sound and feel a shudder. The battle is about to begin.

5 BOSS BATTLE

Detonate a Power Bomb as soon as you enter your battle with the Security Robot. The explosion will set off a chain reaction on the ceiling, revealing a horizontal ladder. Grab onto it, aim for the opening at the top of the robot and hit

it with multiple Missiles. If you get a clean shot at the weak spot from an angle, you'll be in a better position to avoid the robot's leaping attack and its Samus-seeking missiles. When it launches the missiles, fire at them with rapid

Plasma Beam shots. After you've defeated the robot, you'll have to deal with a Wave Beam-firing Core-X. Hit it with Missiles and move to avoid contact with the bulbous beast. Your reward for victory is the Wave Beam.



Detonate a Power Bomb to reveal handle grips on the ceiling.



Hang onto the ceiling and try to target the robot at an angle. When the enemy unleashes missiles, shoot them down with Beams.



SECOND OBJECTIVE Leave Sector 6 immediately.

6 SHOOT THE SWITCH

The Wave Beam that you collected from the last Core-X fires through walls. You can use it to defeat enemies before they attack you and to hit shutter switches. You'll never be on the wrong side of a shutter again.



Return to a shutter in the middle of the sector and open it to collect a Missile Tank.

7 UNAUTHORIZED ACCESS

Even though you don't have authorization, you're probably wondering what's on the other side of the shutter in the lower-left section of Sector 5. Go there, open the shutter and explore.

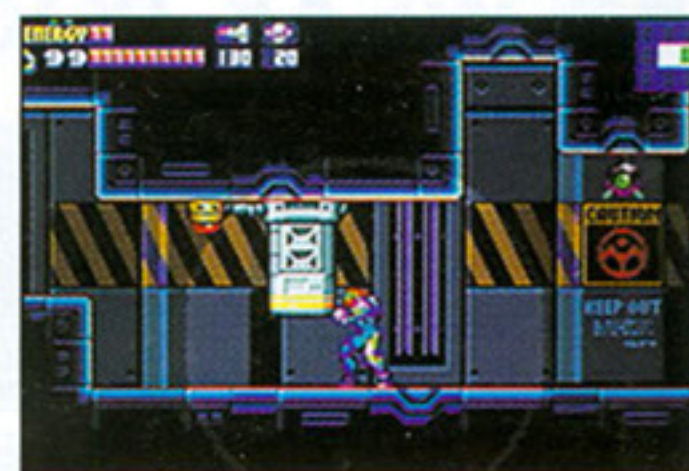

Use the Wave Beam to open the thick shutter and enter the Restricted Zone.

RESTRICTED ZONE

No orders, no information—your journey continues through the Restricted Zone behind a veil of secrecy. Something is brewing. You'll soon uncover the truth.

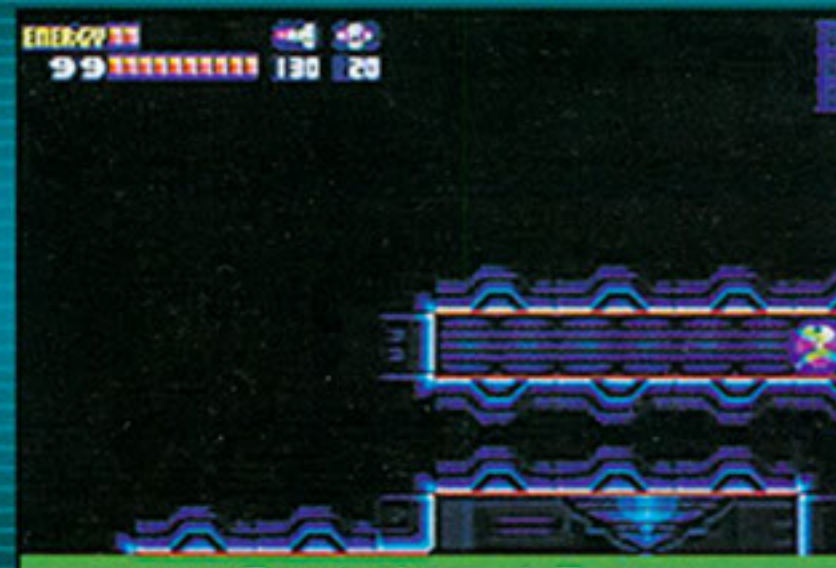

ROOMS, HATCHES AND BLOCKS

S Save Room

SB Boost Block

N Navigation Room

SA Screw Attack Block

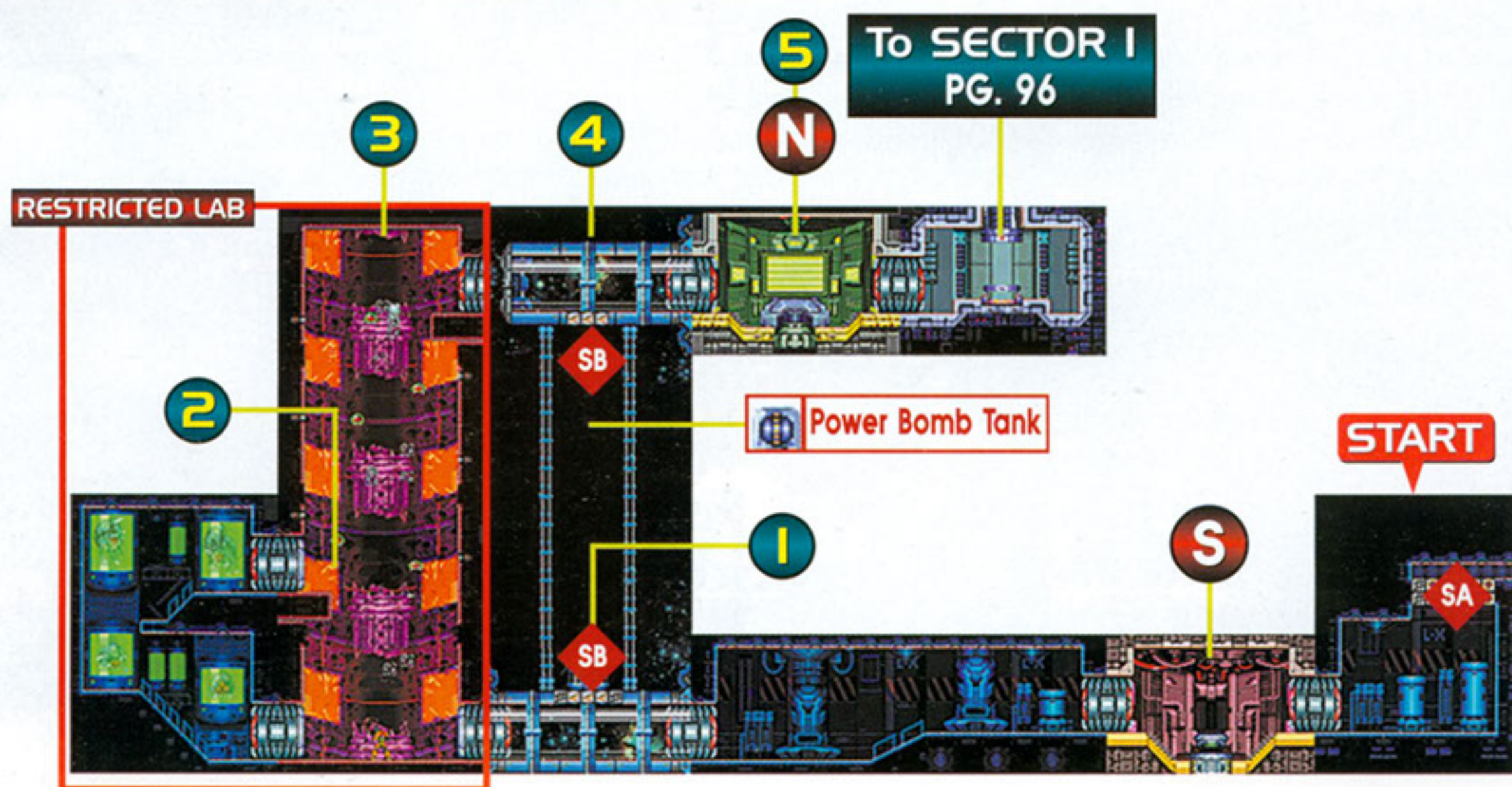

FIRST OBJECTIVE Leave Sector 6 immediately.

1 WEAK ROOF

If you use a Power Bomb in the tunnel to the Restricted Lab, you'll see Boost Blocks on the ceiling. You can break them, but you won't make any progress . . . yet. You'll have much more success when you return to the area later.

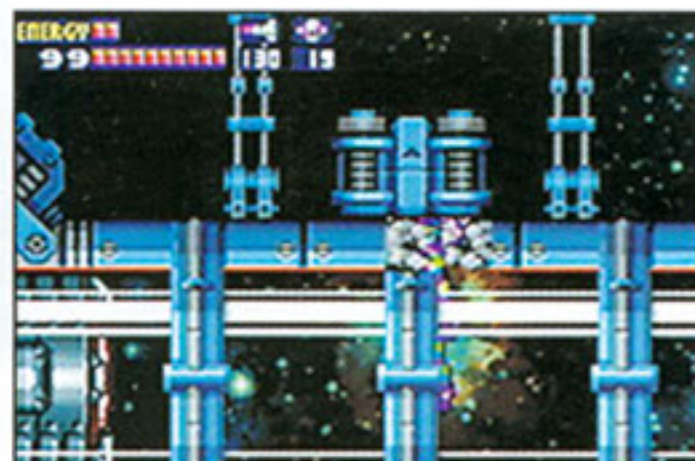

You can destroy the blocks, but a large object impedes your progress.

2 METROID MAYHEM

When you reach the second room of the Restricted Lab, you'll hear a station-rocking explosion. Return to the entrance immediately. Some of the Metroids are loose, and they're attacking the SA-X.



A crisis has occurred in the laboratory. You must investigate the explosion.

SECOND OBJECTIVE Evacuate the Restricted Lab.

3 GONE IN 60 SECONDS

It's not clear what the SA-X's role was in the Metroid crisis, but it is clear that you have only 60 seconds to leave the Restricted Lab. When the clock appears on the screen and begins to count down, that's your cue to Space-Jump out of the long shaft. If you get a quick start, you'll

be able to make some progress before the place is packed with Metroids. If you come into contact with a Metroid, you'll fall and have to start over again. The SA-X will actually help you by picking off some of the Metroids. You'll find a ledge halfway up the

left side of the shaft and another one near the top, on the right side. After you make your way to the first ledge, you'll be able to make easy progress up the left side. When you get to the top, change directions and fly over to a hatch on the right side.



The situation in the lab is about to go critical. You don't want to be there for the finale.



Space-Jump up the left side of the shaft, then float to the right and open the hatch.

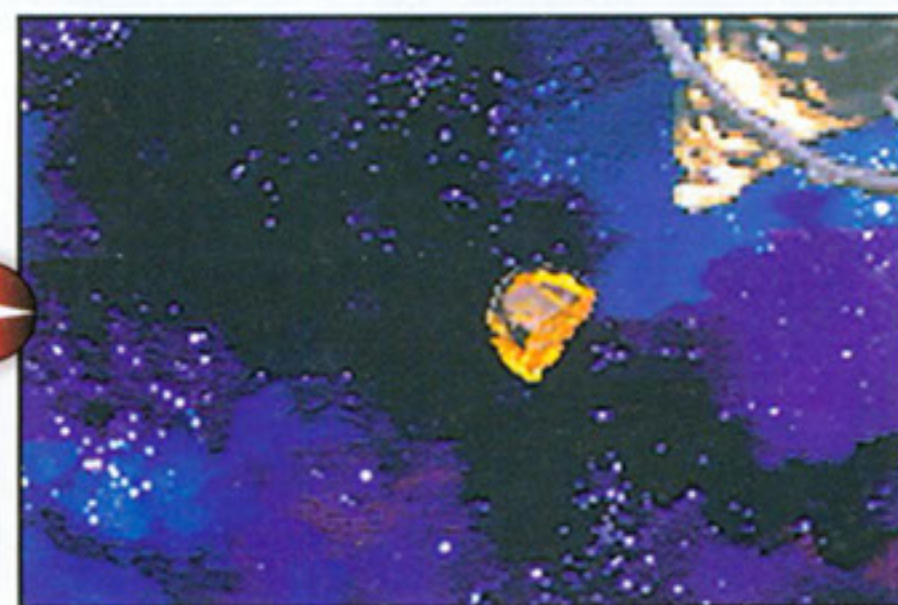

After you reach the hatch, you'll watch as the lab is jettisoned from the station.

THIRD OBJECTIVE Proceed to the Navigation Room.

4 SAFETY AT THE TOP

Your nerve-racking climb up the shaft has led you to a relatively safe part of the Restricted Zone. There is no telling what has happened to the Metroids or the SA-X. You need some answers. You need to know what's been going on. The picture will become clearer after you go to the Navigation Room.

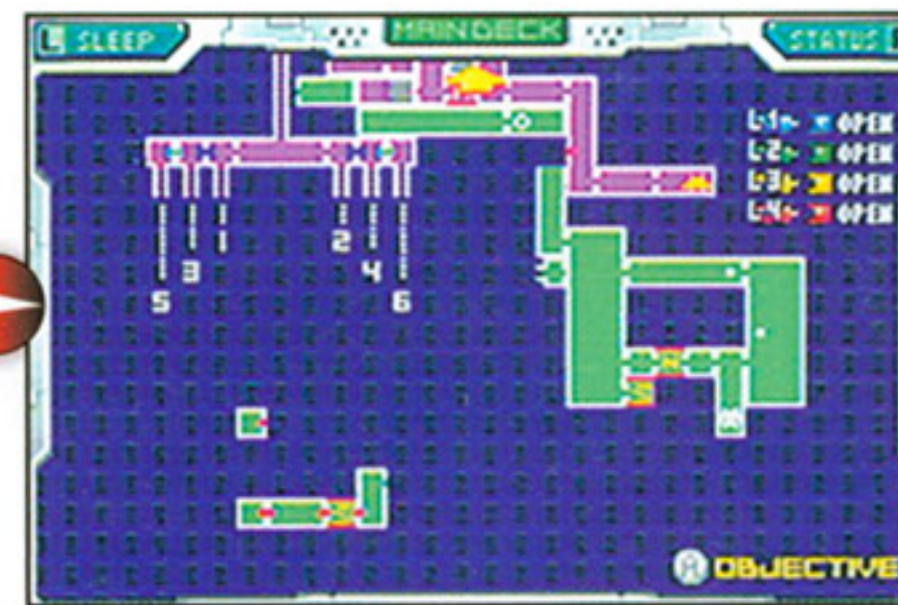
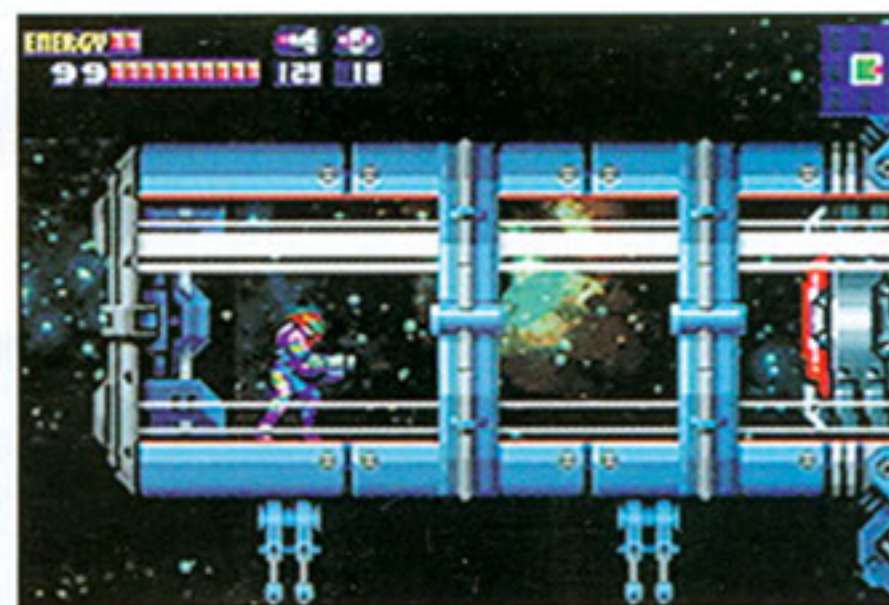

5 THE TRUTH REVEALED

The Federation has been using the research facility to breed Metroids? It's no wonder that the X parasites, natural enemies of the Metroids, were so eager to take over the place. To make matters worse, there are several copies of the SA-X organism aboard the research station—parasite-controlled versions of Samus at the peak of her abilities. You must proceed cautiously and keep in constant contact with the computer.

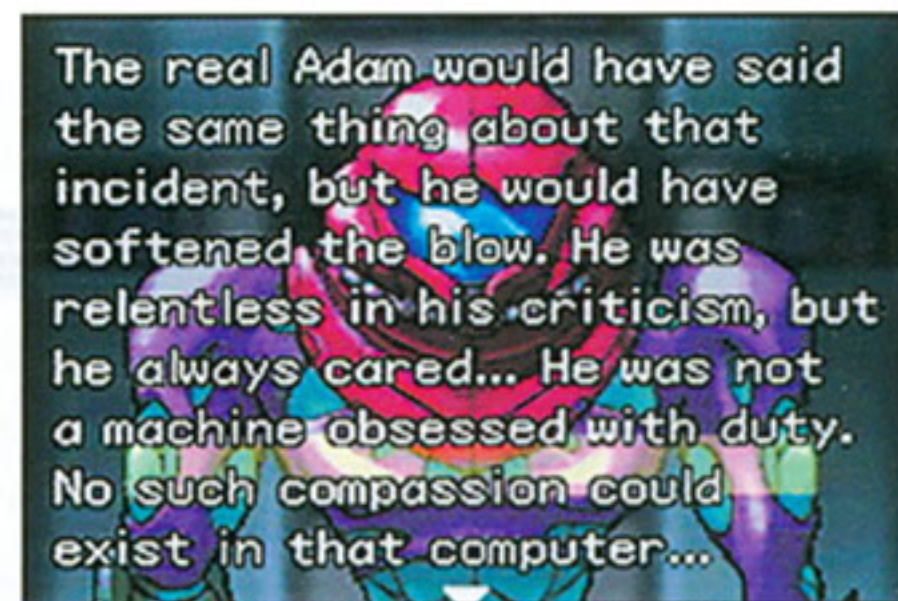

The real Adam would have said the same thing about that incident, but he would have softened the blow. He was relentless in his criticism, but he always cared... He was not a machine obsessed with duty. No such compassion could exist in that computer...

SECTOR I

SRX

There's a lot more to Sector 1 than your previous adventures have shown. As you make your way through unexplored areas, you'll meet an old enemy and collect a powerful ability.

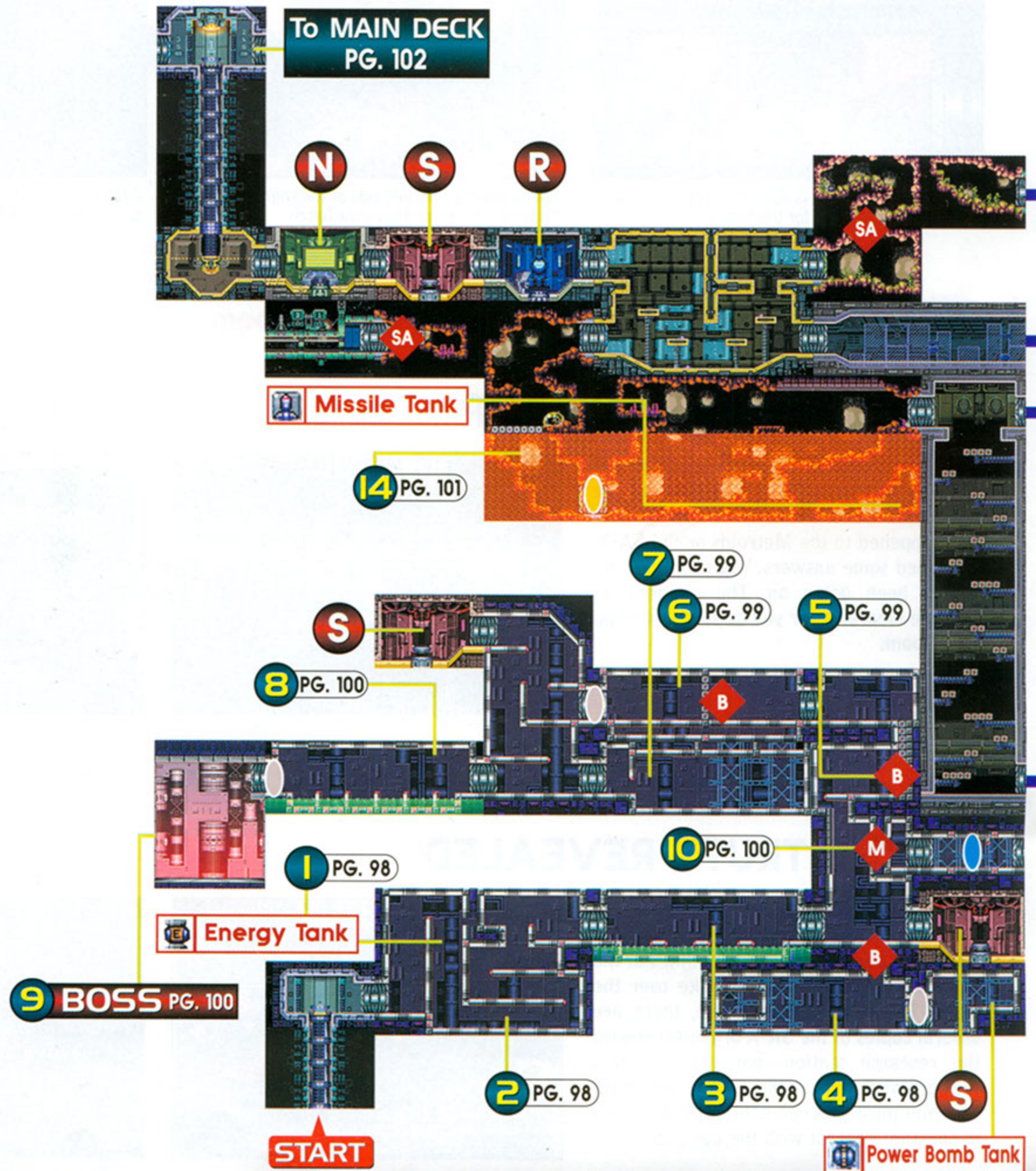
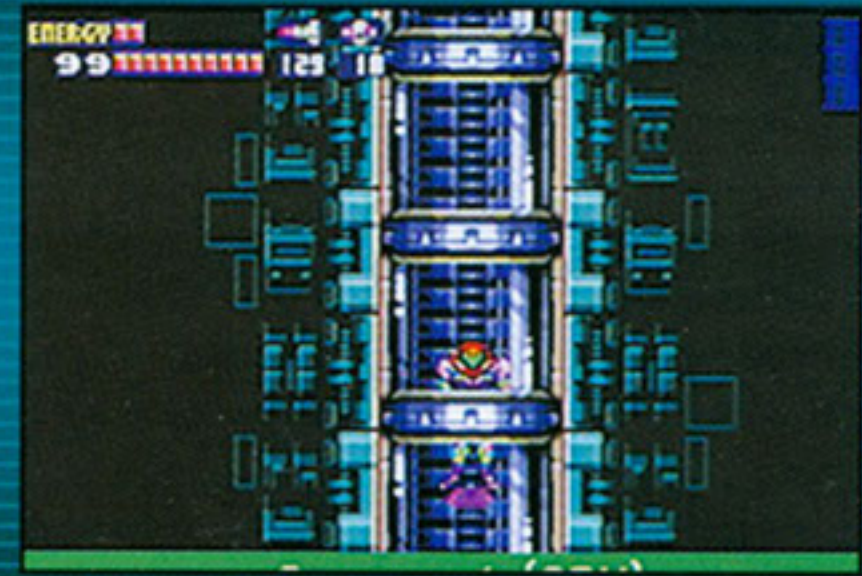

- BLOCKS**
- B** Bomb Block
 - PB** Power Bomb Block
 - M** Missile Block
 - SB** Boost Block
 - SA** Screw Attack Block

- ROOMS AND HATCHES**
- S** Save Room
 - N** Navigation Room
 - R** Recharge Room
 - D** Data Room
 - Level 1 Hatch
 - Level 2 Hatch
 - Level 3 Hatch
 - Level 4 Hatch
 - Special Hatch
 - Shutter

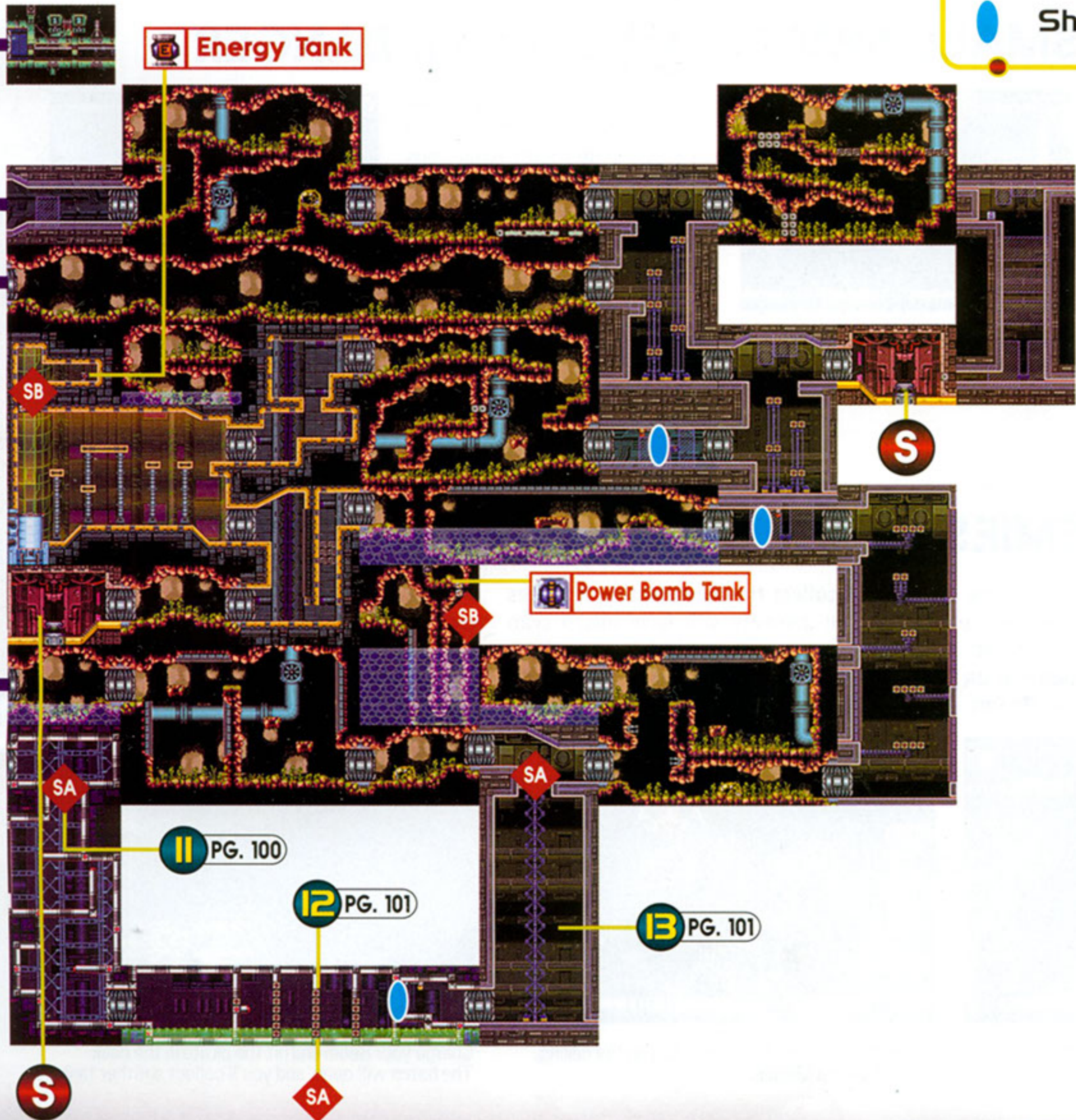

FIRST OBJECTIVE Explore the unknown areas of Sector I.

1 EASY ENERGY

The right side of the vertical passage in the unmapped area is loaded with mindless and seemingly invincible creatures that float back and forth. Charge up and fire a Diffusion Missile from the left side of the room to freeze all of the creatures and reveal an opening in the right wall. Work your way over to the right side, stop on a frozen enemy and jump into the hole. Then use a Bomb to reveal an Energy Tank.

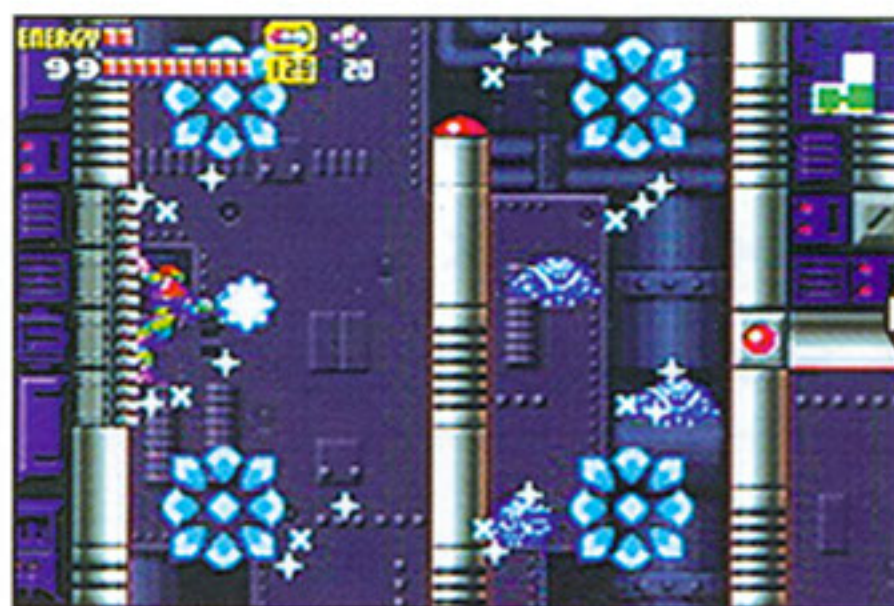

Use a Diffusion Missile to freeze the enemies and open a hole in the wall.

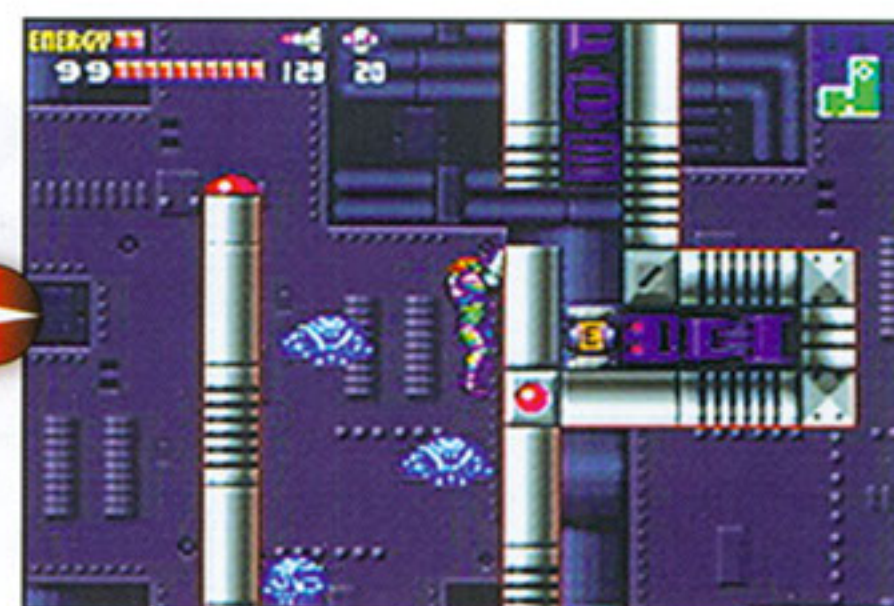

Hop up into the hole and drop to collect an energy-refilling Energy Tank.

2 BIG BUG, SMALL SPACE

On your way to the middle of the sector, you'll encounter large, crablike creatures in a narrow passage. They are impervious to the power of your Wave Beam. Hit them with Missiles and move on.

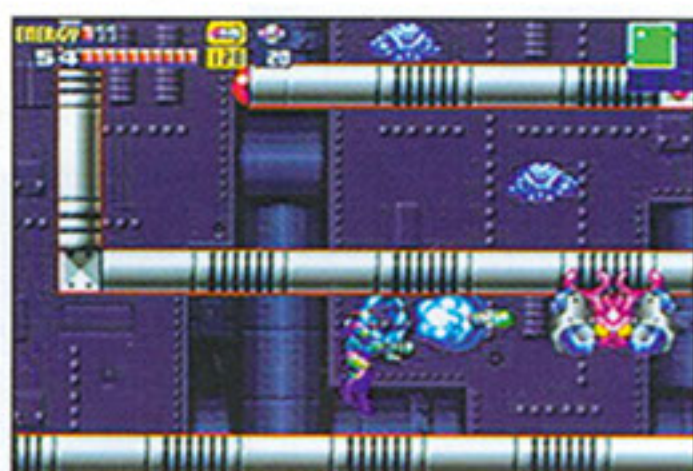

Blast the big creatures with Missiles, then collect the parasites.

3 DOUBLE DANGER

The corridor that takes you closer to the center of Sector I is flooded with dangerous liquid and populated by energy-sapping enemies. Hop across the platforms and take out the flying creatures with rapid Beam blasts.

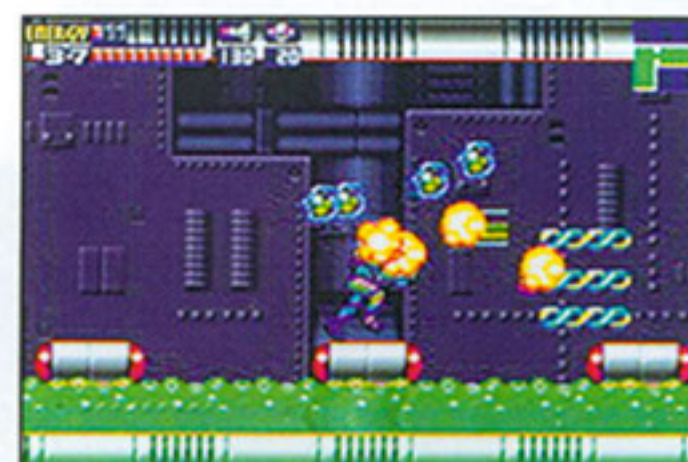

Shoot the enemies while they're still in the air or they'll latch onto you and sap your energy.

4 THREE ENEMIES IN ONE

Before you climb up to explore more of the unknown, blast a hole in the floor with a Bomb and drop into a hall that holds a special hatch. You'll find a single enemy in an enclosed area. Defeat it with Wave Beams,

but don't collect the parasite that it leaves behind. The parasite will form into a crab creature on the ceiling. Blast it with a Missile, but again don't collect the parasite. It will take the form of a gold-colored Zebe-

sian Space Pirate. Charge up your Beam and hit the pirate in the back. When the pirate is gone, the special hatch will unlock. Collect the parasites, then enter the next room and grab a Power Bomb Tank.

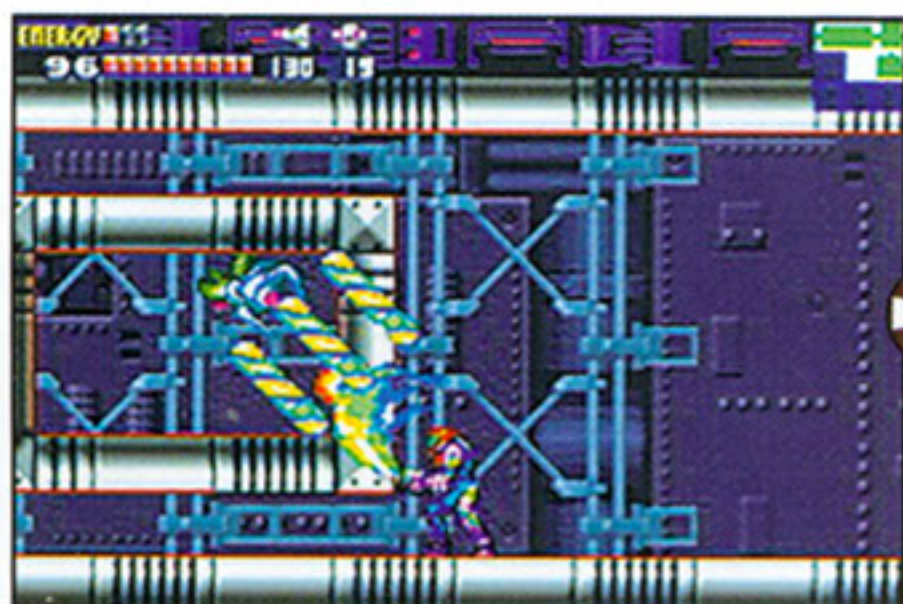

Hit the enemy in the enclosed area with a Wave Beam attack.

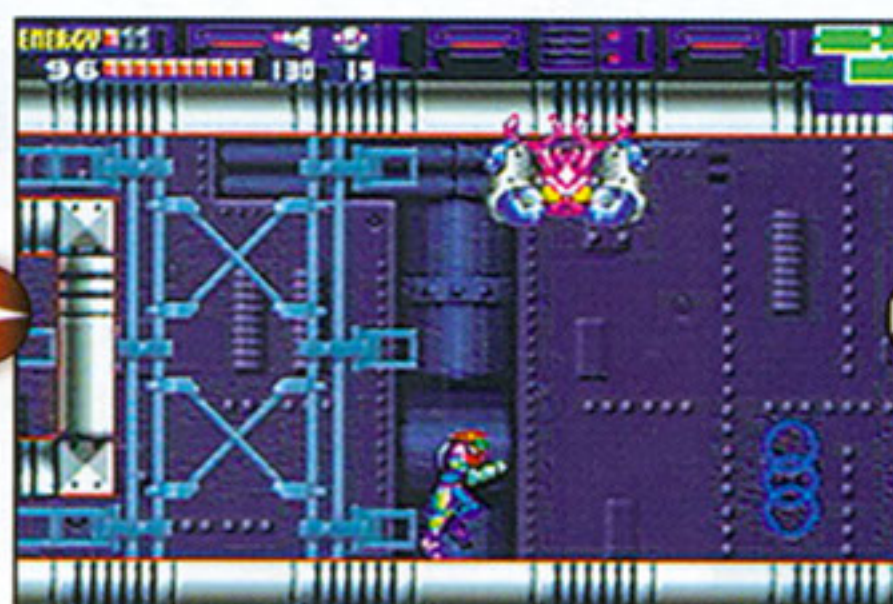

When the parasite becomes a bug on the ceiling, blast it with a Missile.

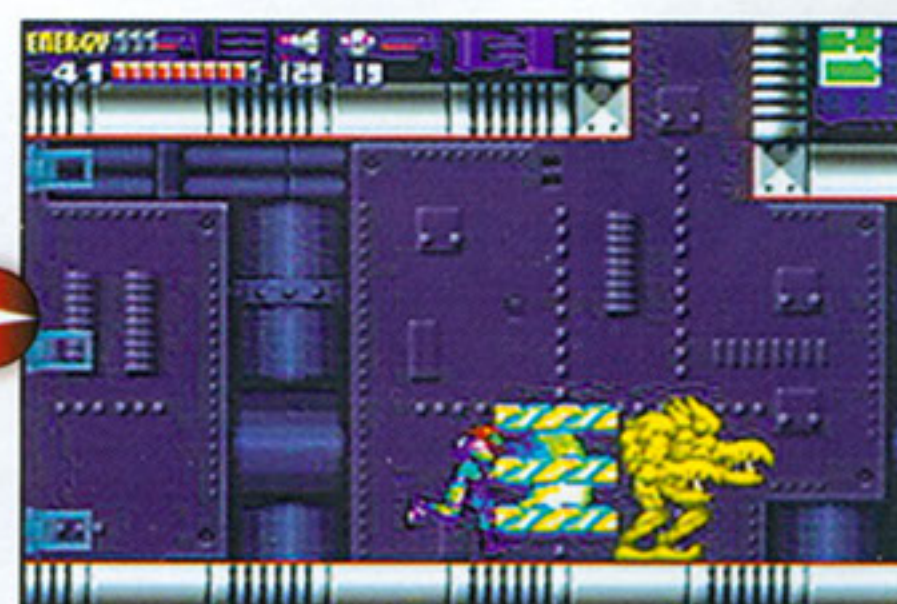

Charge your Beam and hit the pirate in the back. The hatch will open, and you'll collect another tank.

5 BLAST AND CLIMB

As you make your way up the left side of the sector, you'll reach an enclosed area that appears to be a dead end. It's not. Use a Power Bomb to open a hole in the upper-right corner of the room and reveal a ladder on the right wall. Climb up the ladder and continue your journey through the unmapped area.

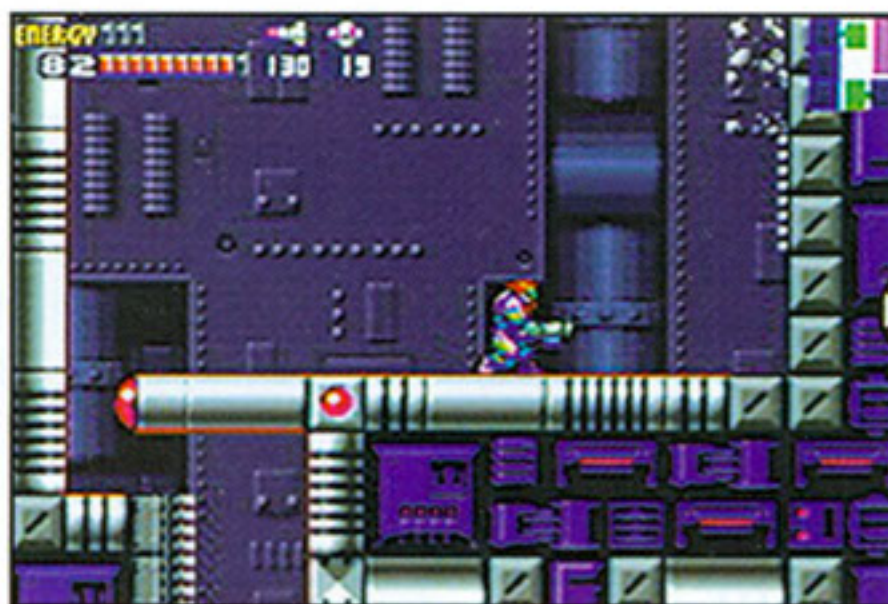

Set a Power Bomb to open a hole in the ceiling and make a ladder appear.

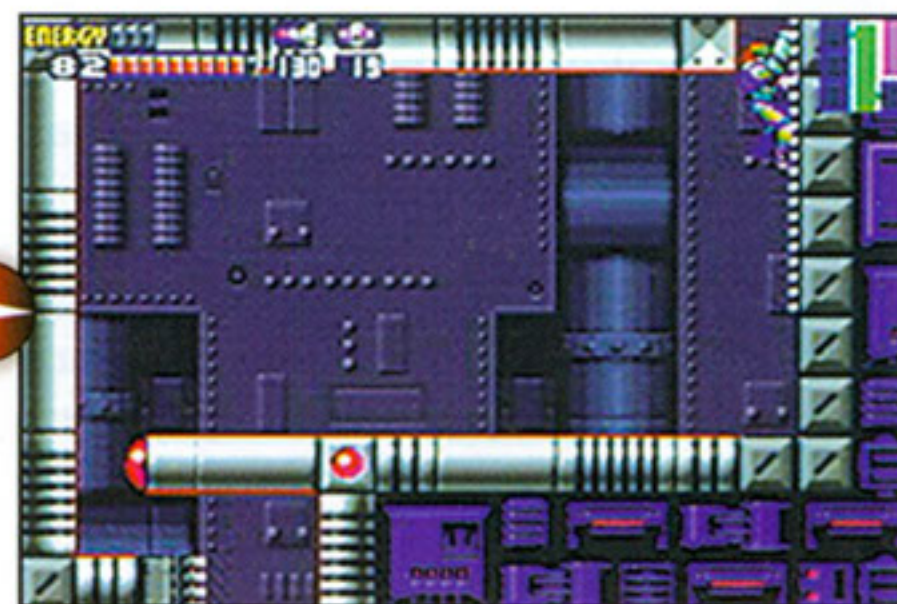

Climb up and out of the room. You're on your way to more unknown territory.

6 PIRATE BATTLE

You'll encounter another special hatch as you make your way left. Bomb the wall in the middle of the corridor and blast one of the enemies under the floor with your Wave

Beam. The enemy's parasite will become a gold-colored Space Pirate. Jump over the pirate's blasts, charge up the Wave Beam and hit the creature in the back. After you

defeat it, it will reform. Defeat it again to open the hatch. Before you move on, defeat the other enemies under the floor with Wave Beam blasts and collect their parasites.



Blast one of the enemies under the floor and let its parasite become a Space Pirate.

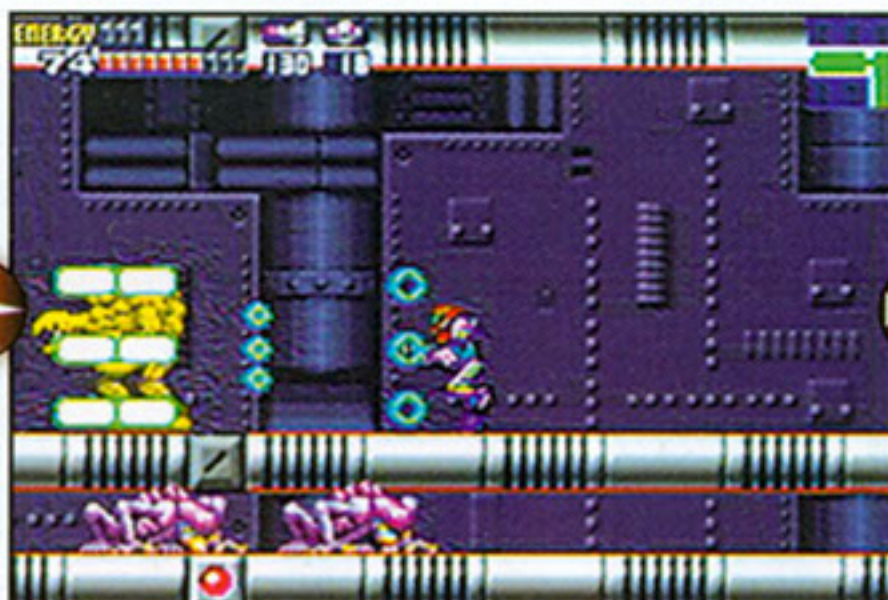

Hit the pirate in the back with charged Beam shots. When it reforms, hit it again.

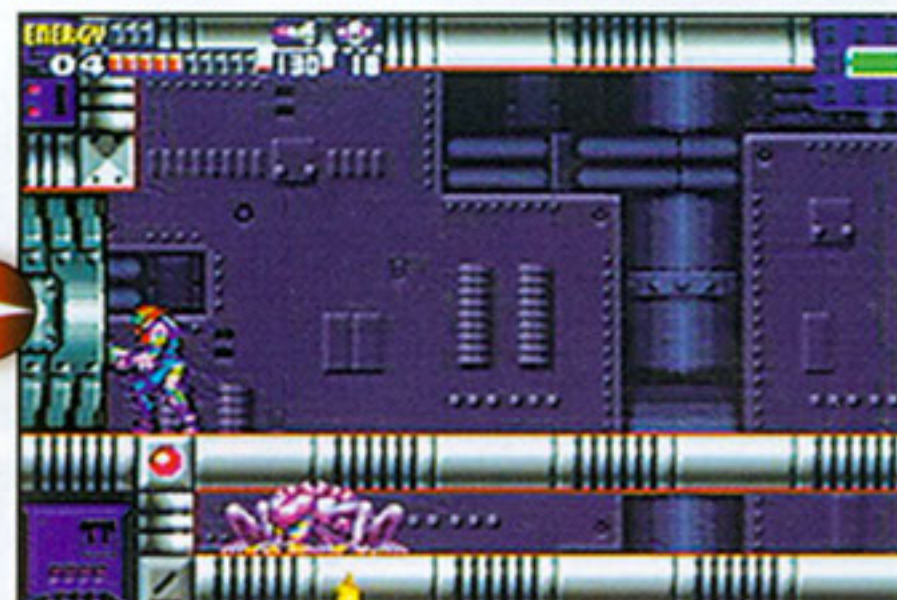

After you defeat the golden creature twice, the special hatch will open.

7 ENERGY PLAN

Your war with the enemies will leave you with a lot of empty tanks. Before you move on to more dangerous battles, take the time to regain some of your lost energy. Hit the enemies that populate the rafters with Wave Beam shots and collect the parasites they leave behind. If two parasites collide, they will form a gold enemy. Run away, leave the room, then reenter and take on another wave of creatures to collect energy-giving parasites.

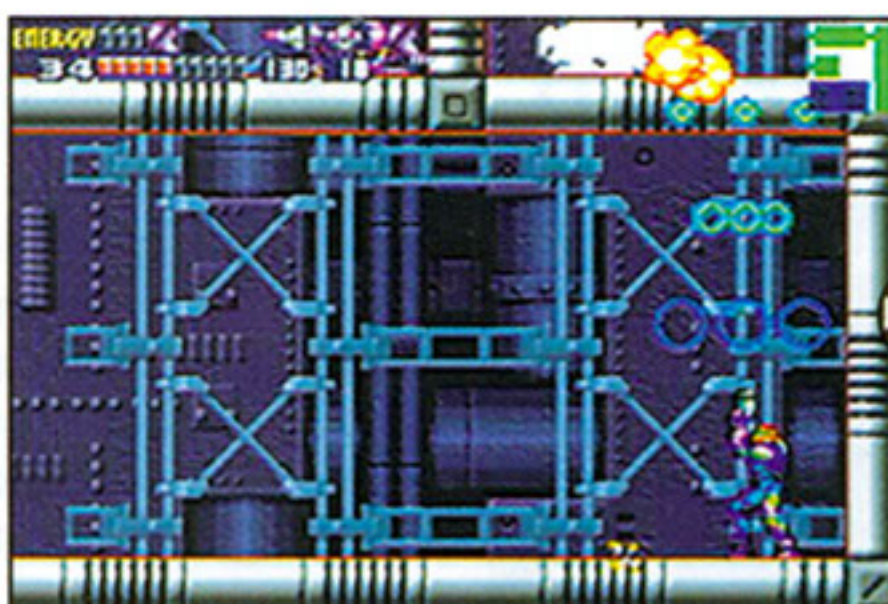

Take on the enemies and avoid their acid drips. You can defeat each beast with a few Wave Beam shots.

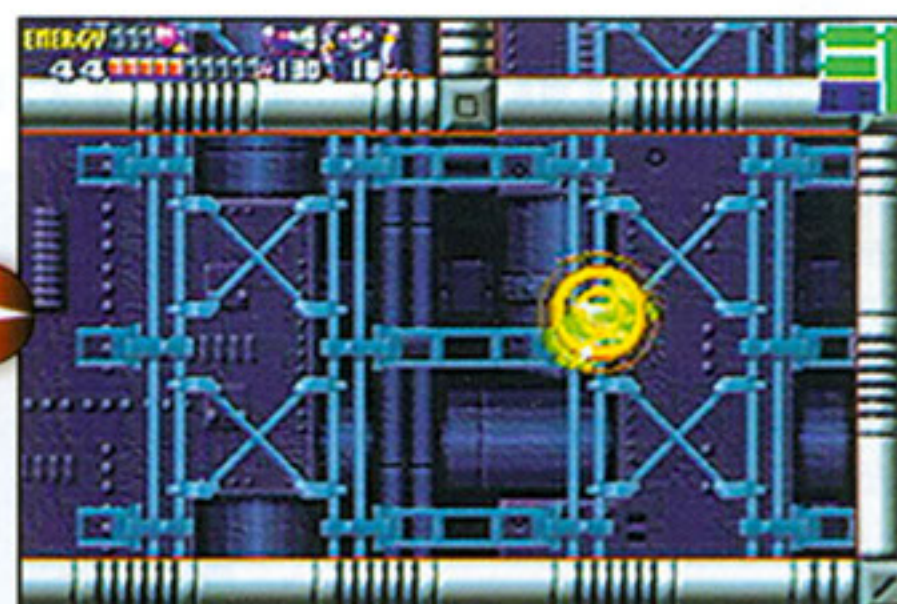

When the parasites begin to float, jump to collect them and regain some of your energy, Missiles or Power Bombs.

8 STICK AND MOVE

The passage that leads to the boss arena is flooded with dangerous water and packed with flying creatures. Use Diffusion Missiles to freeze the enemies, then hop onto the frozen creatures to prevent yourself from falling into the water. When you reach the end of the hall, you'll fight a giant eye. Hit it with a Missile when it shows its pupil and be sure to collect the red X parasite that it leaves behind.



Freeze the flying enemies in the long hallway with Diffusion Missiles then use them as platforms.

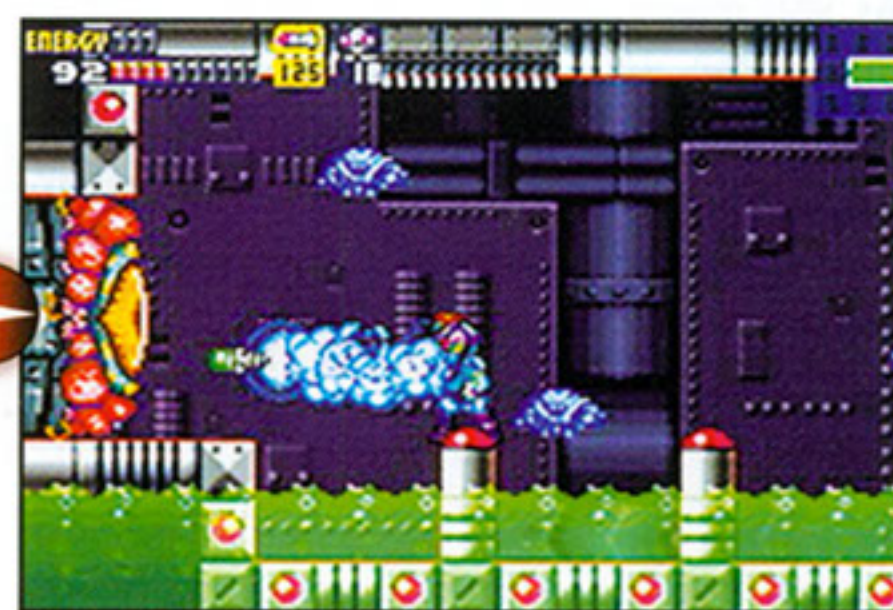

Blast the beast at the end of the hallway, collect the parasite then enter the boss arena.

9 BOSS BATTLE

Ridley, the big beast that rules Sector 1, is not hard to hit, but it is incredibly tough. You'll need more than 100 Missiles to defeat it. Run under Ridley while it's in the air and fire up

with a continuous Missile attack. Avoid the boss's swinging tail and fireball attack, and keep looking for an opportunity to hit it with Missiles. You'll lose energy in a hurry if the

boss picks you up, but at least you'll be able to continue your Missile attack. After you beat the boss, you'll fight a Core-X for the Screw Attack upgrade.

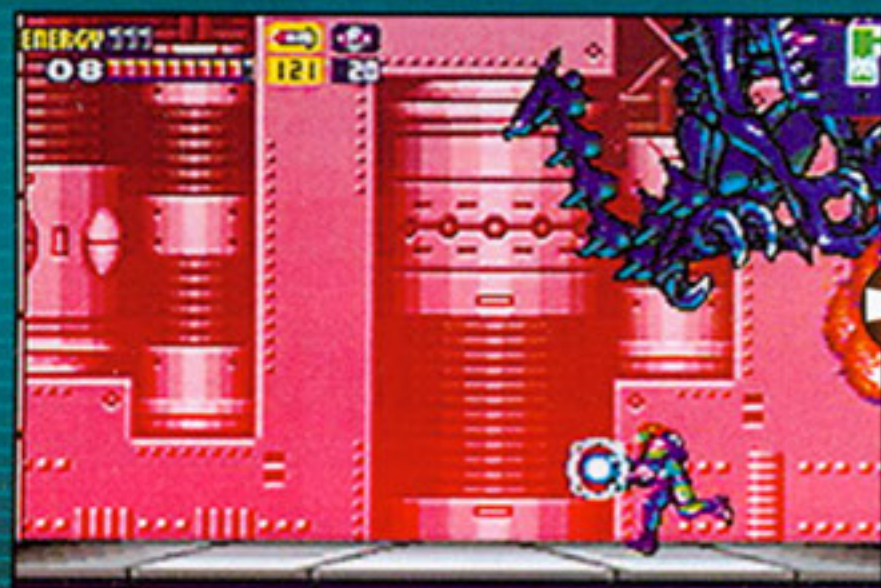

Avoid Ridley's attacks as you run under the beast, and fire up with an continuous Missile barrage.

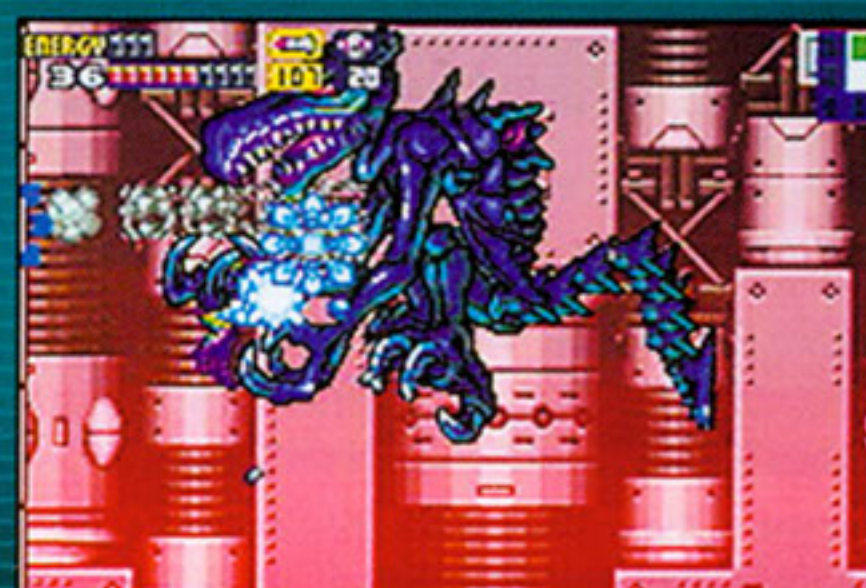

Even if Ridley picks you up, you can continue to hit the beast with Missiles.

SECOND OBJECTIVE Proceed to the Navigation Room.

10 TUNNEL TO THE HATCH

On your way back through familiar territory, you'll reach an enclosed hatch. Hold onto the ladder on the left wall and fire Missiles to the right. You'll create a tight tunnel. Hop, hang and roll to the right.

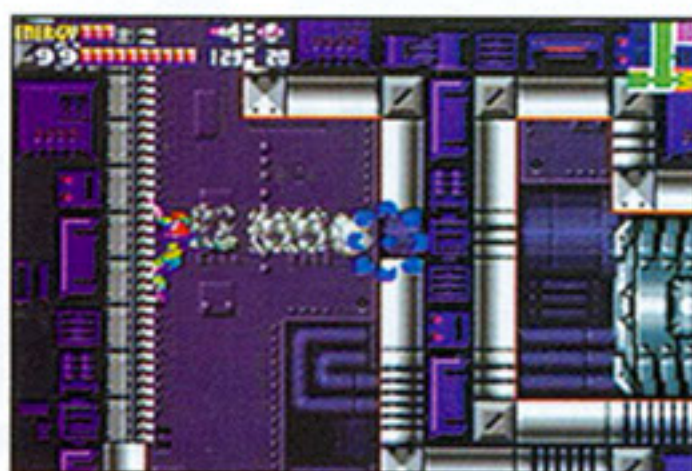

Destroy the barrier with Missiles then move to the right.

11 SCREW LOOSE

If you use a Power Bomb in the dead end, you'll reveal a line of Screw Attack Blocks. Jump, somersault and crash into the blocks. Your powerful new ability will allow you to break through the barrier.

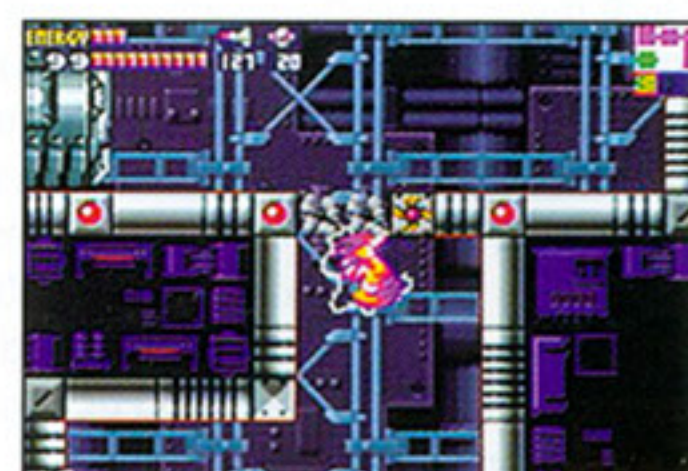

Nothing can stop you now. Break through the Screw Attack Blocks with a spin.

12 FLY AND BREAK THROUGH

Those mindless, floating fiends aren't invincible after all. You can blaze through a wave of them and through several wall sections as you Space-Jump with Screw Attack power. Fly over the damaging water and move to

the right, through the long corridor. When you get to the end, straighten out and aim your Wave Beam at the shutter switch. After the shutter opens, hop into a hole in the barrier and roll through to the next

area. You'll use the Screw Attack a lot in your continuing quest to explore the unmapped sections of the station. Keep going and don't let anything stand in your way.

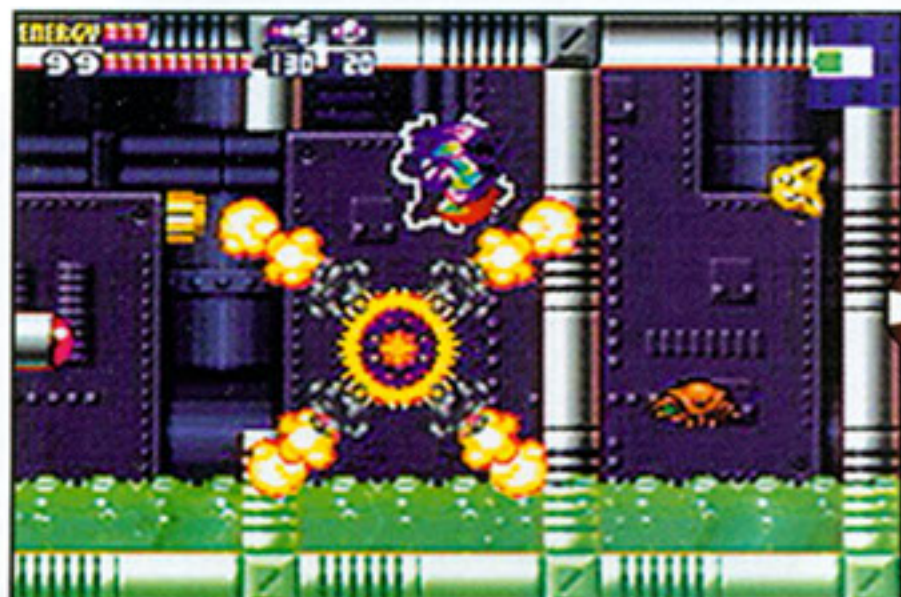

Screw through the enemies and wall sections in the long corridor.

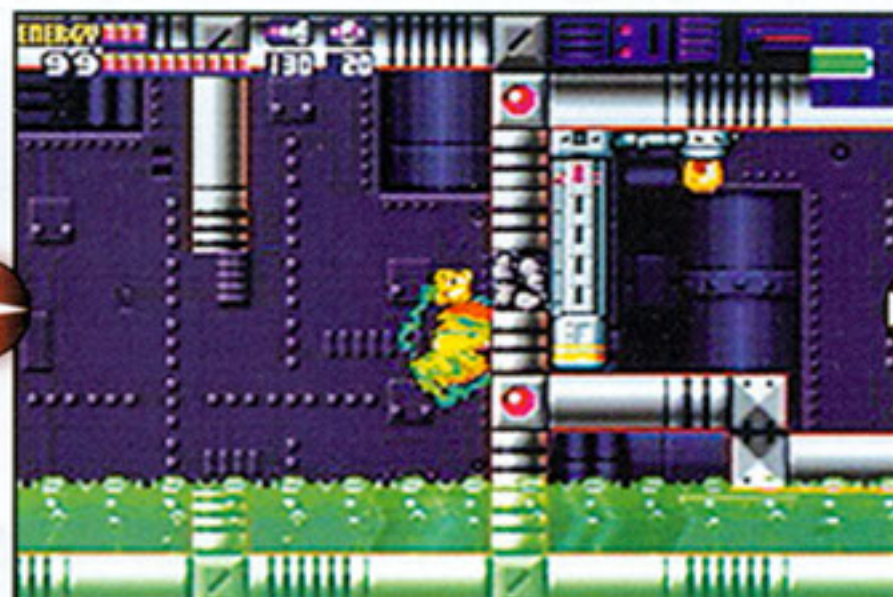

Make a small hole in the last barrier, then straighten out and aim to the right.

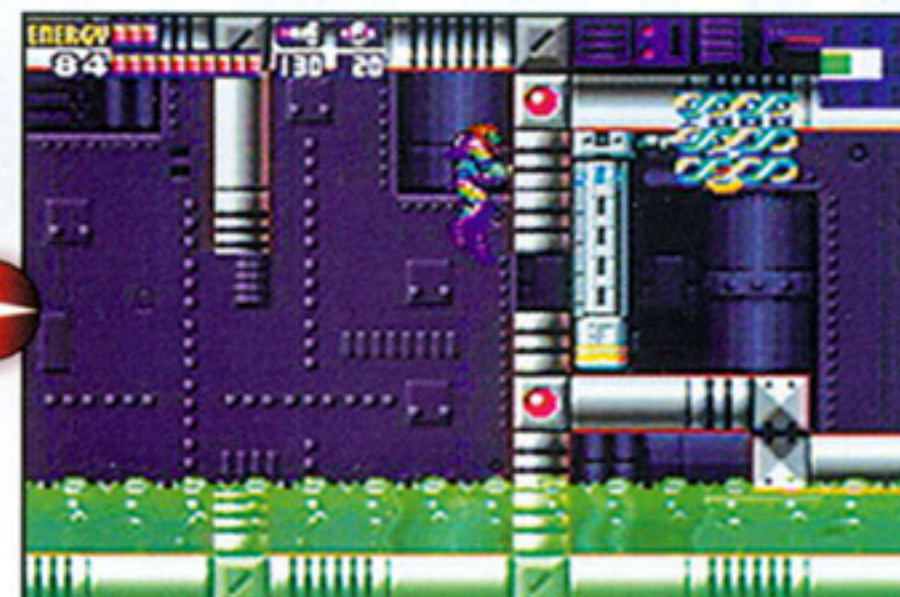

Hit the shutter switch with your Wave Beam, then roll up, hop and move.

13 SCREW UP

You should be a master of the Space Jump by now. When you find yourself at the bottom of a long, vertical passage, you'll know what to do—jump, spin and float to the top. You'll blaze invincibly through the wall-crawling enemies and their shots. When you reach the top, aim for the striped barrier. You'll make short work of it with the Screw Attack.

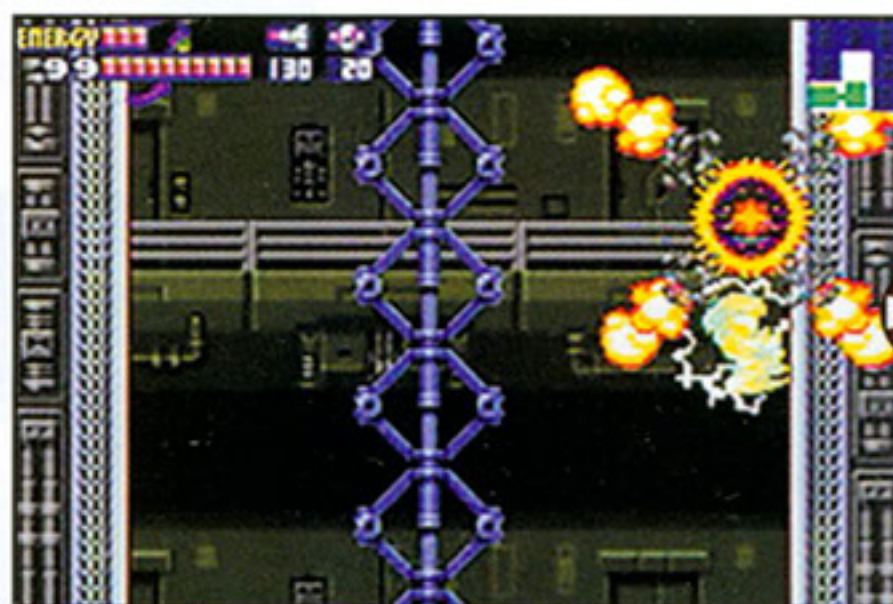

Fly to the top of the vertical passage and don't mind the enemies. If you hit them, you'll defeat them.

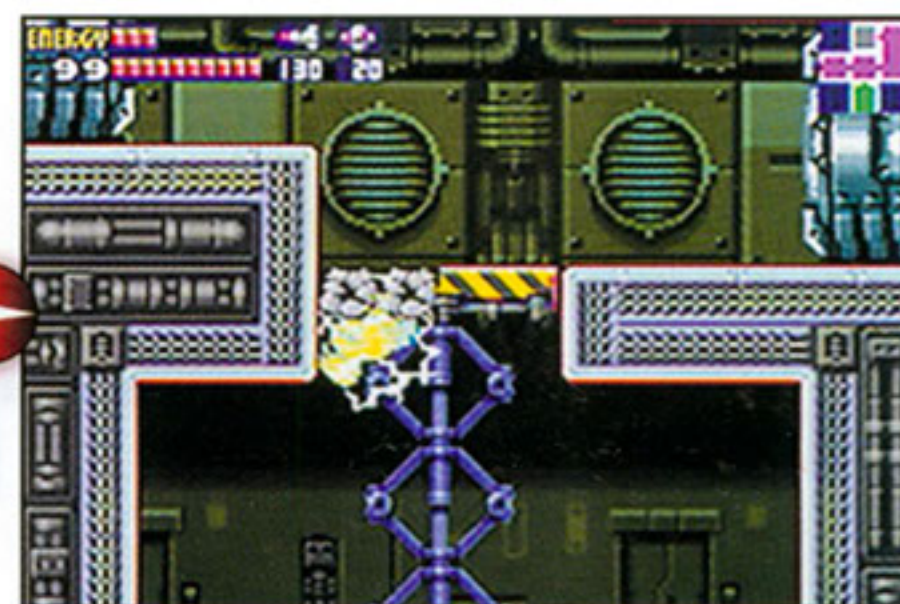

When you reach the top, fly through the striped barrier and Space-Jump up to solid ground.

14 LAVA DISCOVERIES

You are one tough bounty hunter. You can blaze through almost anything with your Screw Attack, and you can withstand molten lava with your Gravity Suit. Dive into the lava in the left side of the sector

and explore the lava floor. You'll find a hidden passage in the lower-right area. Roll into it for a Missile Tank. Leap out of the lava and fly to the upper-left corner of the large chamber to find another Missile Tank

on a ledge. After you have both tanks, drop to the lower-left section and leave the area through a green hatch. You'll discover a shortcut passage to the Sector 1 entrance.

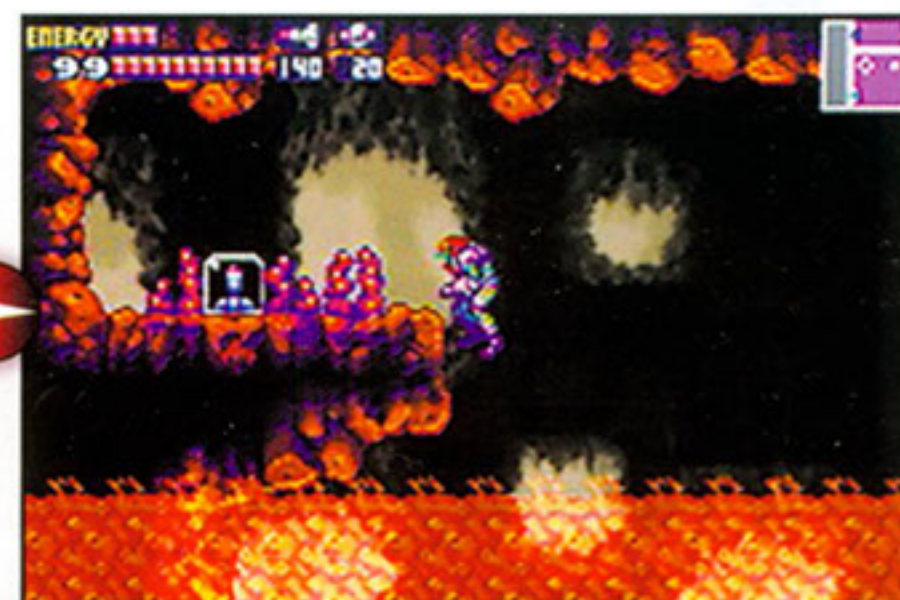
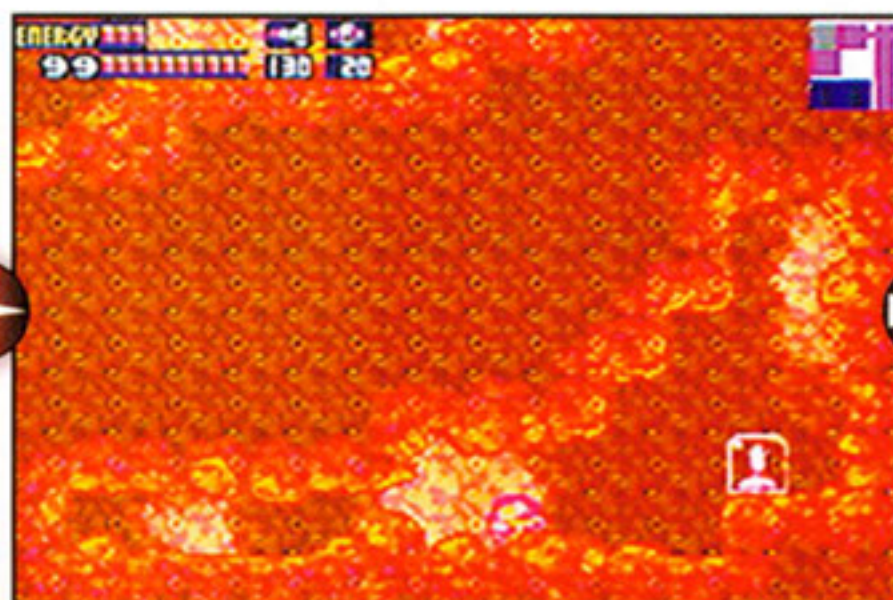
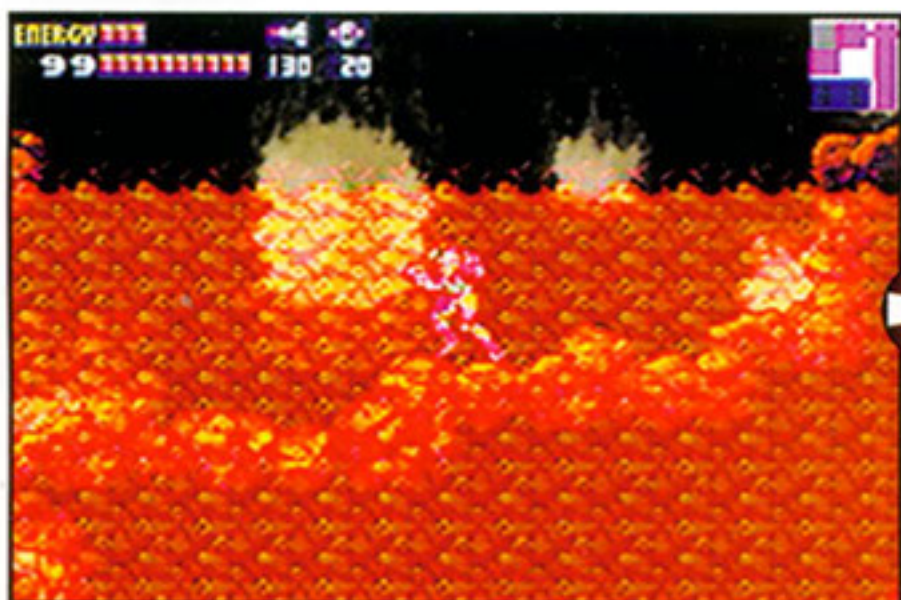

MAIN DECK

Members of the Federation are on their way to try to trap and keep the SA-X. You can't let that happen. Your only hope is to run the station into the ground.

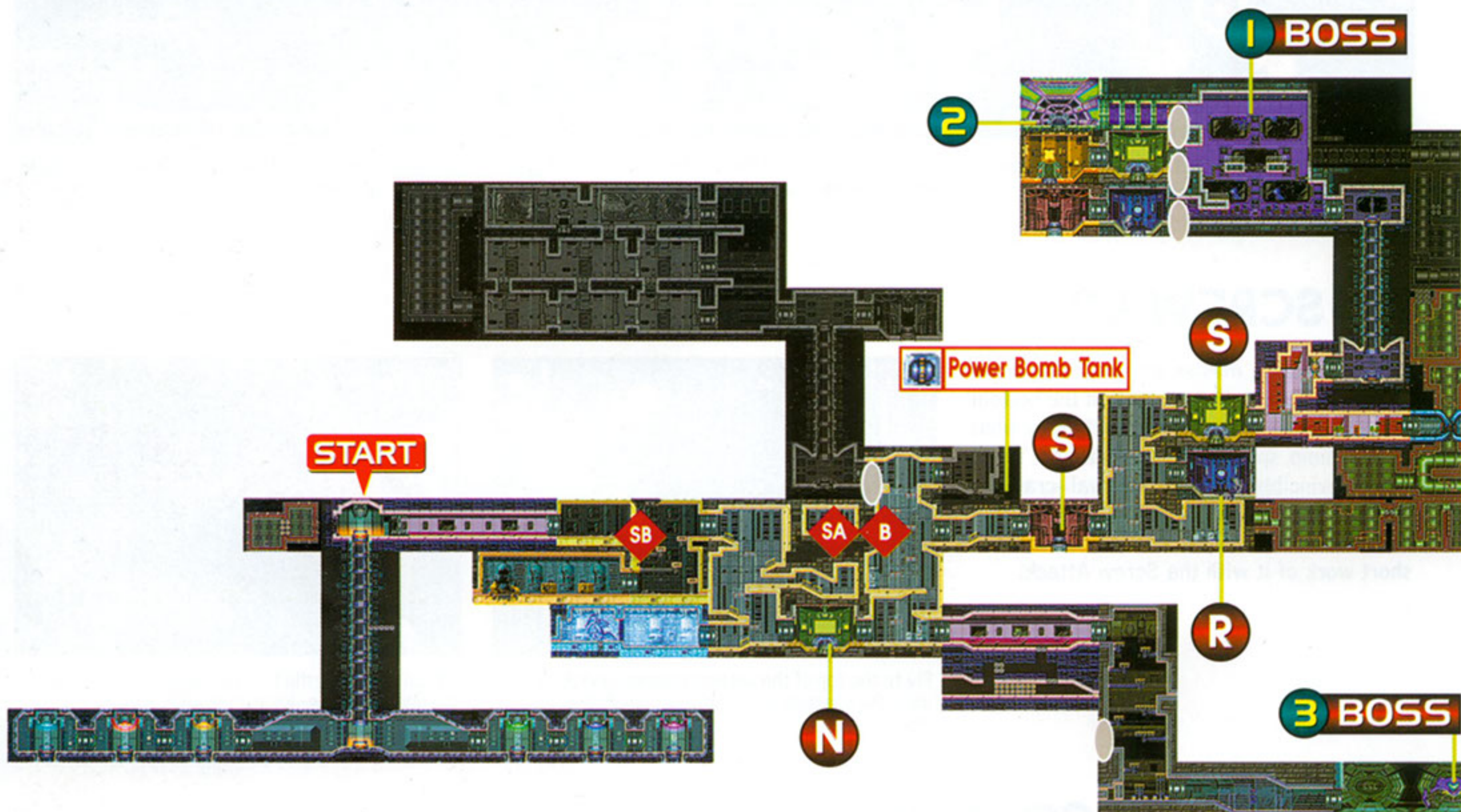

ROOMS, HATCHES AND BLOCKS

- | | |
|--------------------------|------------------------------|
| S Save Room | B Bomb Block |
| N Navigation Room | SB Boost Block |
| R Recharge Room | SA Screw Attack Block |
| ● Level 2 Hatch | |
| ● Special Hatch | |

OBJECTIVE Set the orbit to impact SR388. Return to the ship and evacuate.

1 BOSS BATTLE

Before you can open the hatch that leads to the Operations Room, you'll face off with an SA-X. The enemy moves quickly and fires a very powerful version of the Ice Beam. You

can temporarily freeze the SA-X with Missiles, but your primary weapon should be charged Wave Beam shots. Charge on the run while the SA-X chases you, then turn,

fire and get out of the way. After you pummel the SA-X, it will transform into a huge, grotesque version of itself. Hit it again with more charged Beam shots.

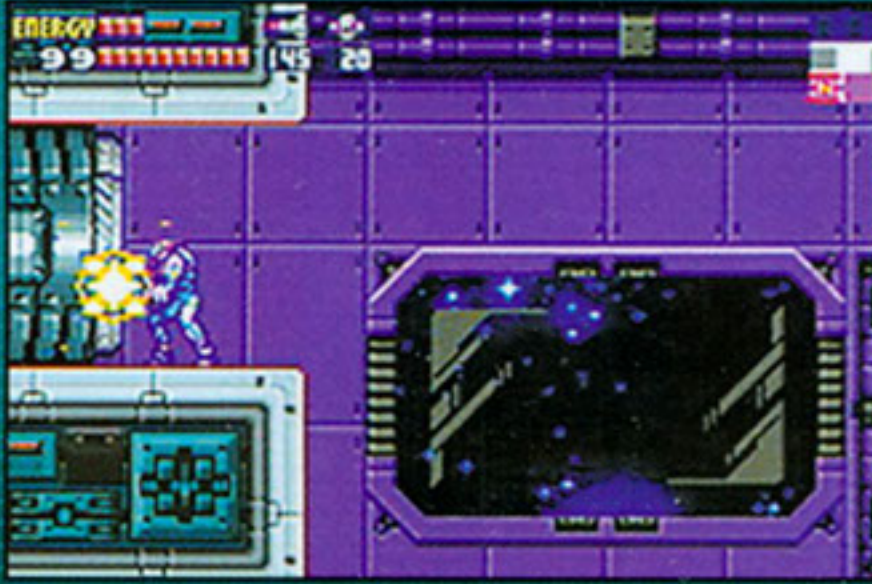

The hatch to the Operations Room is locked. When you reach it, the SA-X will attack.



Hit the fast fiend with charged Wave Beam shots and continue your attack after it transforms.

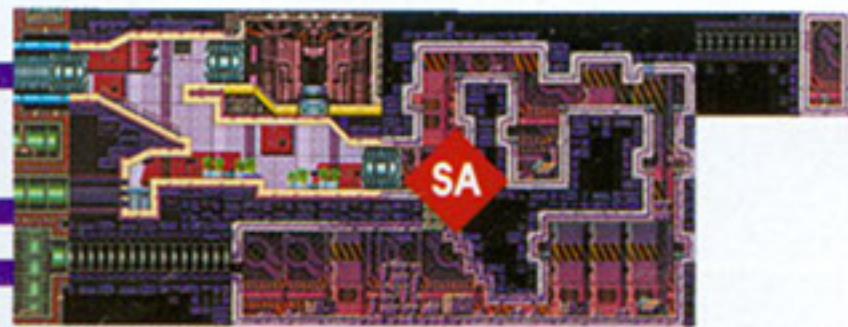

2 COLLISION COURSE

Once the SA-X is history, you'll be able to enter the Operations Room. The only way to destroy the research station is to send it on a collision course for SR388. The countdown will start at three minutes. You must return to your ship before time runs out, or you'll go down with the station.



Time will start ticking down after you alter the station's orbit. Run to your ship and escape.

3 BOSS BATTLE

There's a hole where your ship used to be—and a huge, sharp-clawed Omega Metroid that aims to make sure you don't leave the space station in one piece. The beast will knock out

all of your energy with a few swipes. Then an SA-X will appear and try to beat the creature. After the Metroid has made short work of the SA-X, you can collect the SA-X's parasite to

fill your tanks and absorb the power of the Ice Beam. Charge toward the Metroid and hit it with rapid-fire Ice Beam shots. When you're done, the ship will soar into the scene.



After the creature knocks you to the ground, the SA-X will give it a try.



Collect the SA-X's parasite for a full recharge and ready the Ice Beam to attack with newfound force.



QUEST FOR PERFECTION

The game's five endings show different images of adventurer Samus Aran. You'll have to be quick and complete to see the best endings. Play through the game repeatedly and try to get a different ending every time.

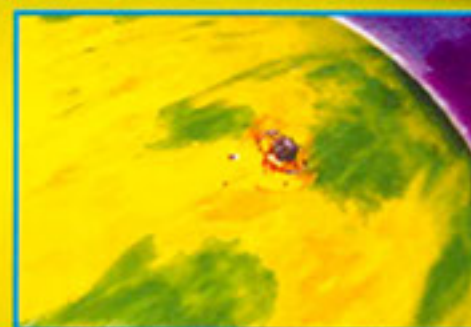

ENDING CONDITIONS

The game ending that you earn is dependent on your total playing time and whether or not you collected every tank in the game. Each of the 100 tanks counts for one percentage point on the final screen. Playing time does not accumulate while you're viewing the map or status screen or in Sleep Mode.



The ending screen will clue you in on your playing time and item collection percentage—the two factors that determine the final image.

ENDING	ITEMS COLLECTED	CLEAR TIME
ENDING 1	100%	under 2:00
ENDING 2	under 100%	under 2:00
ENDING 3	100%	over 2:00
ENDING 4	under 100%	between 2:00 and 4:00
ENDING 5	under 100%	over 4:00

COMPLETION OPTIONS

After you complete the game, you'll have the chance to continue your game or start over. If you choose to continue, you'll return to a time when the station is still in orbit and the SA-X still remains a threat. But you will have access to all of the sectors by way of the Main Deck, so you can go back and collect all of the tanks. If you choose to start over, the game will start from the beginning. Both selections give you some additional data on the map screen. In the upper-left area, statistics show the number and variety of tanks you've collected and the station's tank totals. Your total playing time appears in the lower-left corner.

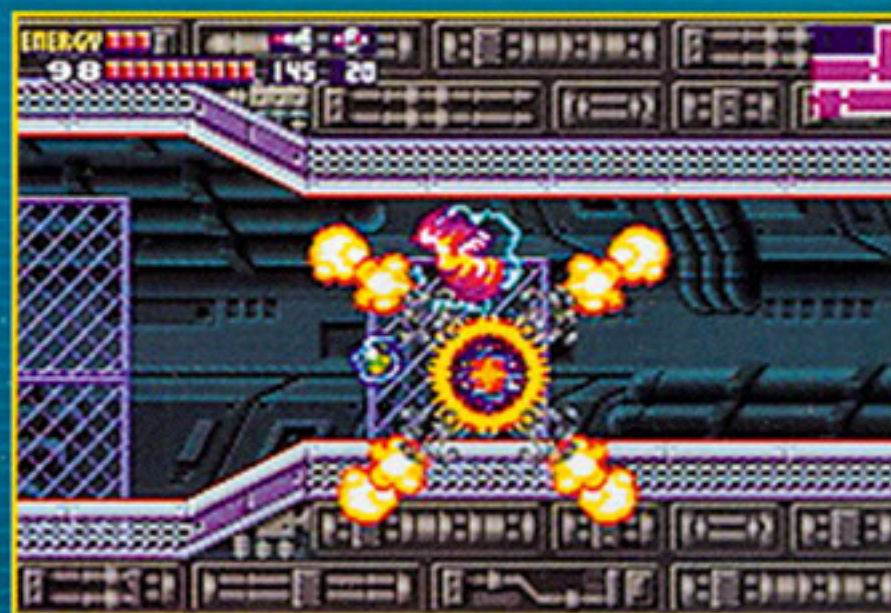

Continue a cleared game and enjoy easy access of the lower sectors from the Main Deck.

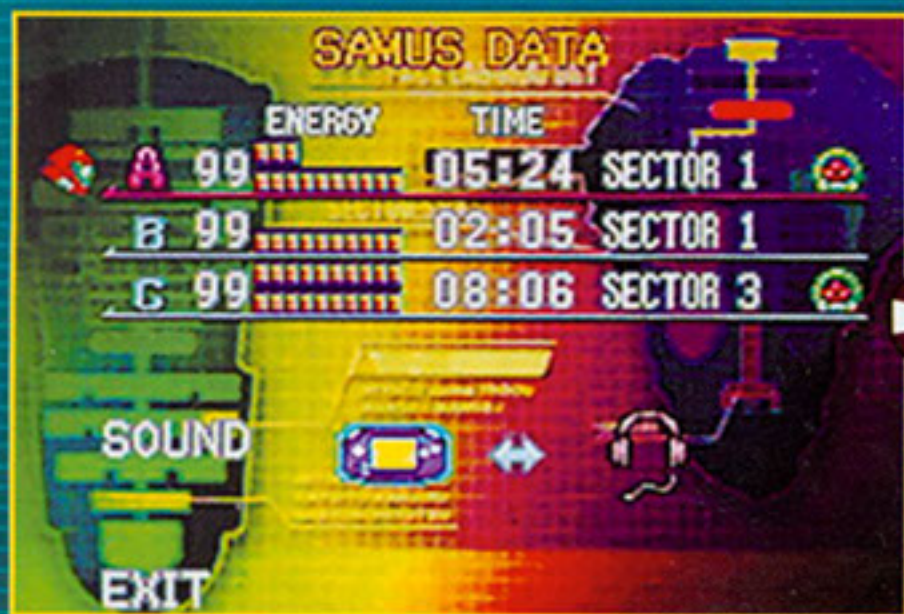

A Metroid icon designates games that you have completed. The icon will remain even if you start over.

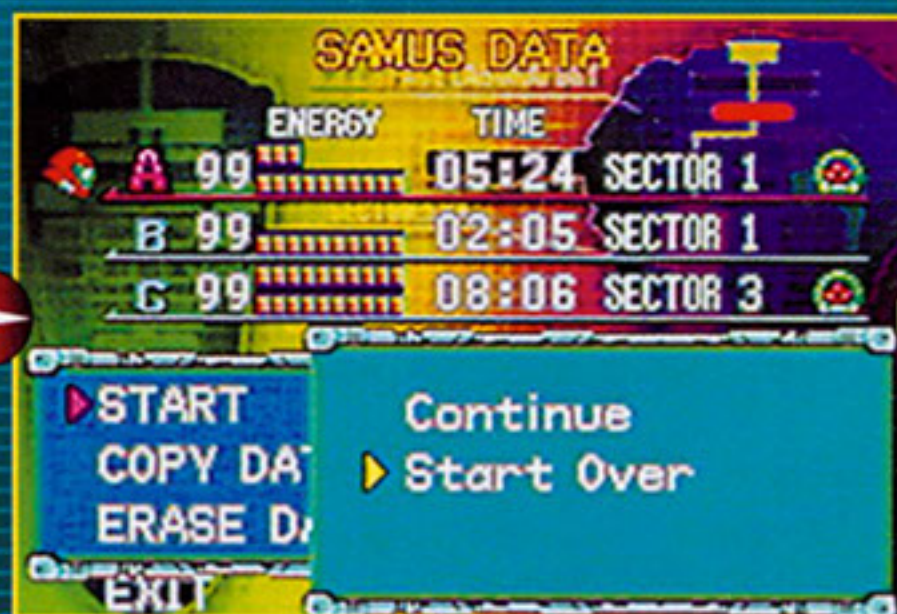

Two choices will appear when you select a file for a game that you've completed. The map screen will change regardless of which one you choose.

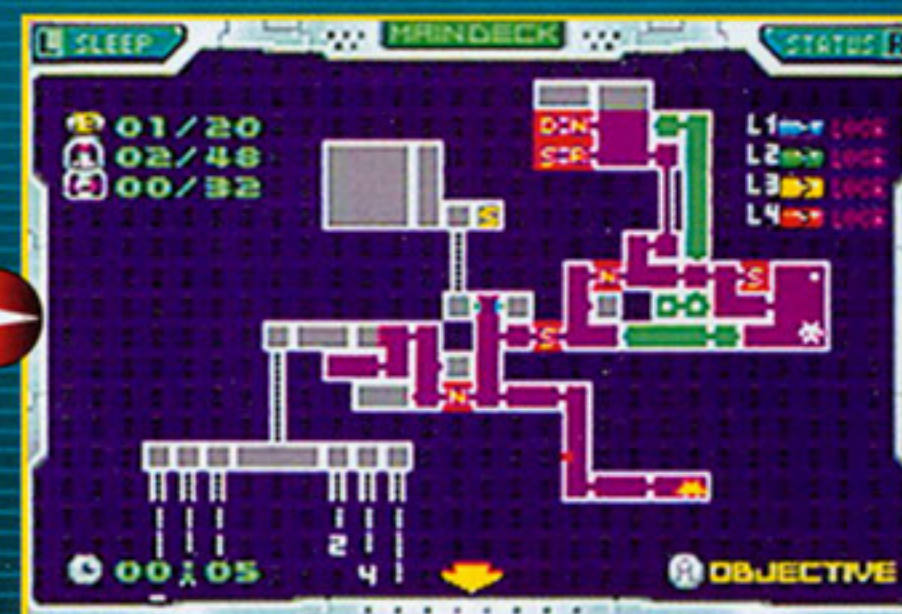

You can use the new information on the map screen as you strive to get the game's best ending.





TANK Trials

TANK TRIALS

You'll need perfect adventuring skills and advanced abilities to earn every item in the game. Explore thoroughly and leave no barrier unbroken.

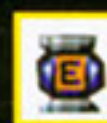
MAIN DECK

 = 3/20

 = 7/48

 = 2/32

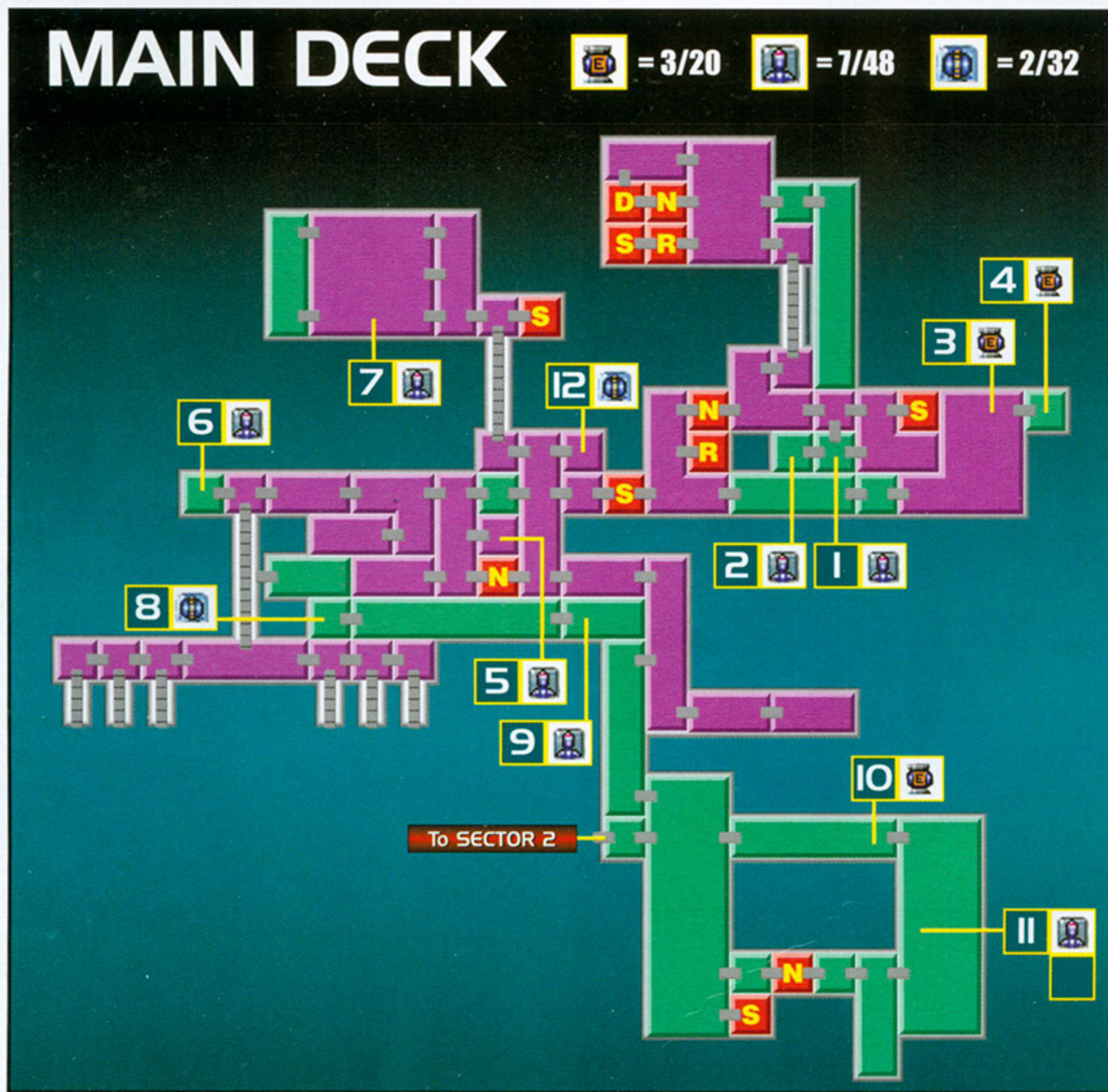

1 When you download Missile data, you'll start with a 10-Missile capacity. After you drop through the vertical passage that runs parallel to the elevator shaft, you'll expand your carrying capacity by five Missiles by picking up a Missile Tank.

2 If you run to the left after you collect your first tank, you'll find what appears to be an empty room. Hop onto the first step and fire your beam to the left. You'll uncover another Missile Tank.

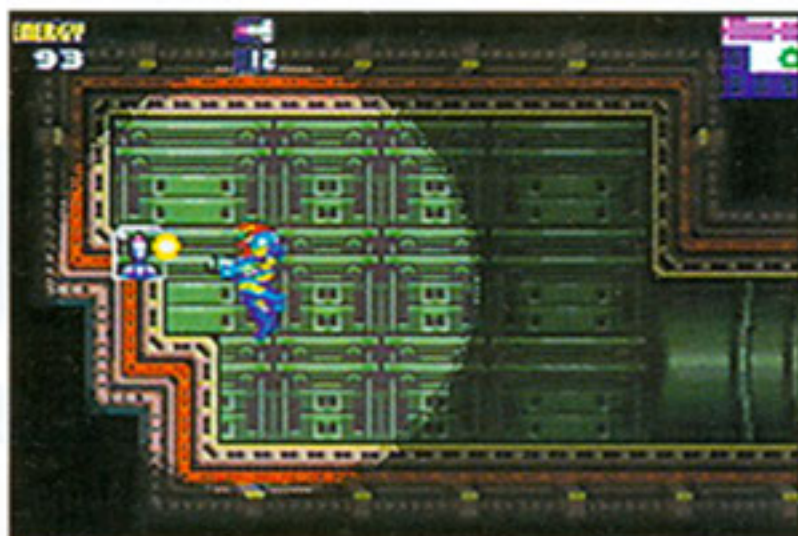

3 You'll need all of the energy you can get on your way to the first boss battle. As you climb from ledge to ledge in the area above the target, you'll discover an Energy Tank in the middle of the path.

4 Immediately after you collect the first Energy Tank, launch two Missiles into the ceiling. You'll open a passage that leads to another Energy Tank. Jump up and follow the passage to the right.

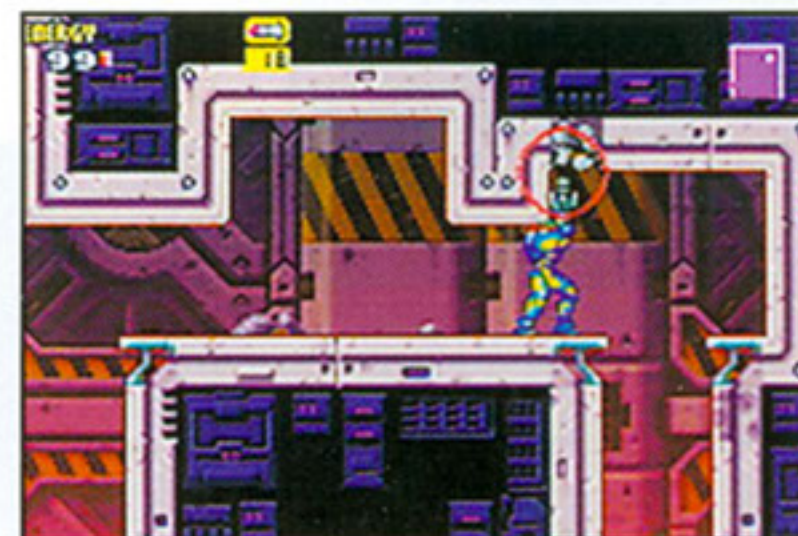

5 Take a quick detour to a Missile Tank on your way to Sector 1. Morph into ball form and roll through a tight passage to the tank. If you've collected all three available Missile Tanks, you'll have a carrying capacity of 25 Missiles.

6 The SA-X created a hole to the left of the elevator shaft. When you run through the hole, you'll find a Missile Tank on the other side of a Boost Block barrier. Leave the room and run to the right until your Speed Booster charges, then turn and run to the left. Your booster will charge again as you enter the new room, and you will bust through the barrier. Collect the tank and move on.



7 When you reach the lower-left corner of the Habitation Deck, open the shutter to the right and collect a Missile Tank. Then run back to the left and jump into the hidden shaft.

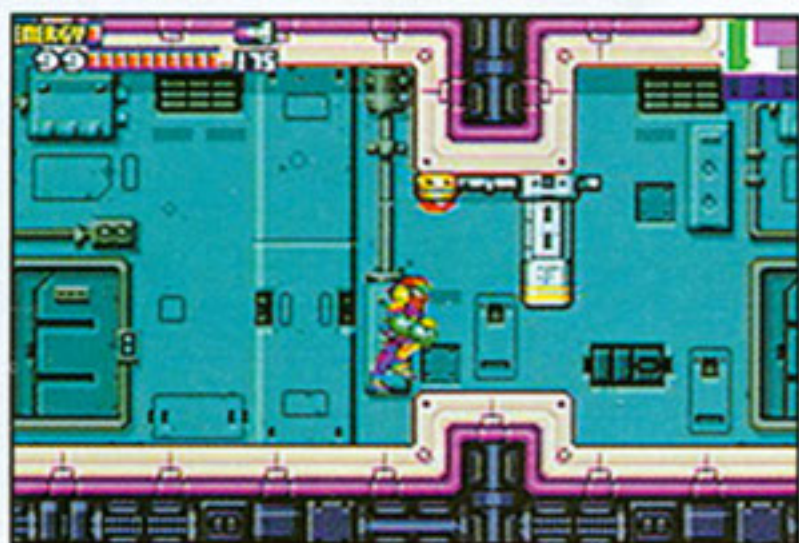

8 After you collect Power Bombs, you'll return to the Main Deck only to experience a power shortage. Once you bomb your way out of the frozen elevator, you'll find yourself in the subzero storage then you'll drop down to a tunnel. Use a Power Bomb there to expose a narrow passage. When you get to the end of the passage, use another Power Bomb. You'll uncover a Power Bomb Tank.



9 The unmapped tunnel under the Main Deck tapers to an end. When you use a Power Bomb in the area, you'll open a passage to the Main Deck and uncover a tank among the crates.



10 As you investigate the problem with the Reactor Core and take on Zebesian Space Pirates, your path will lead you to an Energy Tank. You'll need it for the battle ahead.



11 The Reactor Core is a maze of steel girders. By using Bombs in the right places and navigating your way over to the left side of the vertical area, you can discover the path to a Missile Tank.

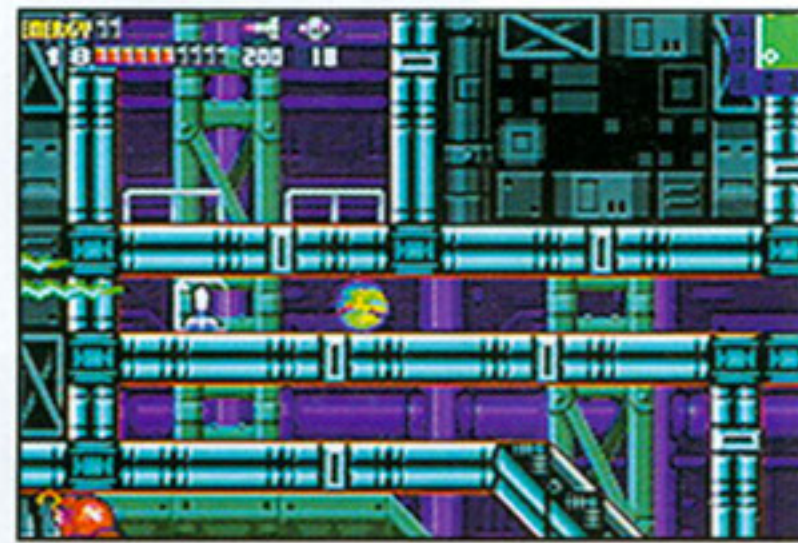

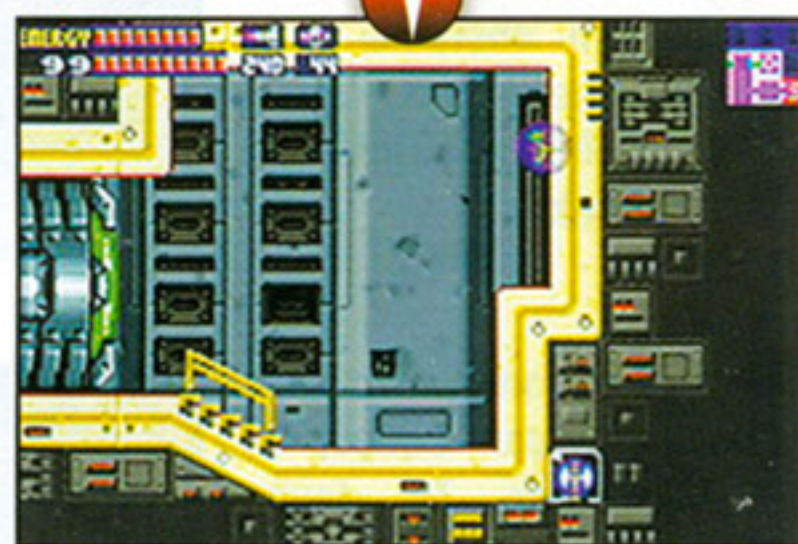
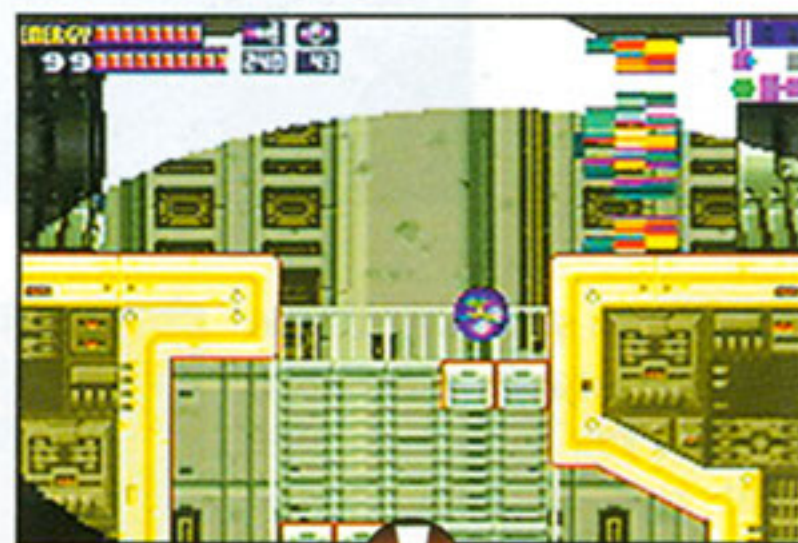

12 Use a Power Bomb to destroy the living barrier that blocks the Level 2 security hatch in the middle of the Main Deck. Then enter the room and jump over to the ledge on the right side of the room. Roll into a ball, hop up and to the right, into a hidden passage, then make your way around to a Power Bomb Tank in the lower-right corner.



SECTOR I

 = 3/20

 = 6/48

 = 3/32

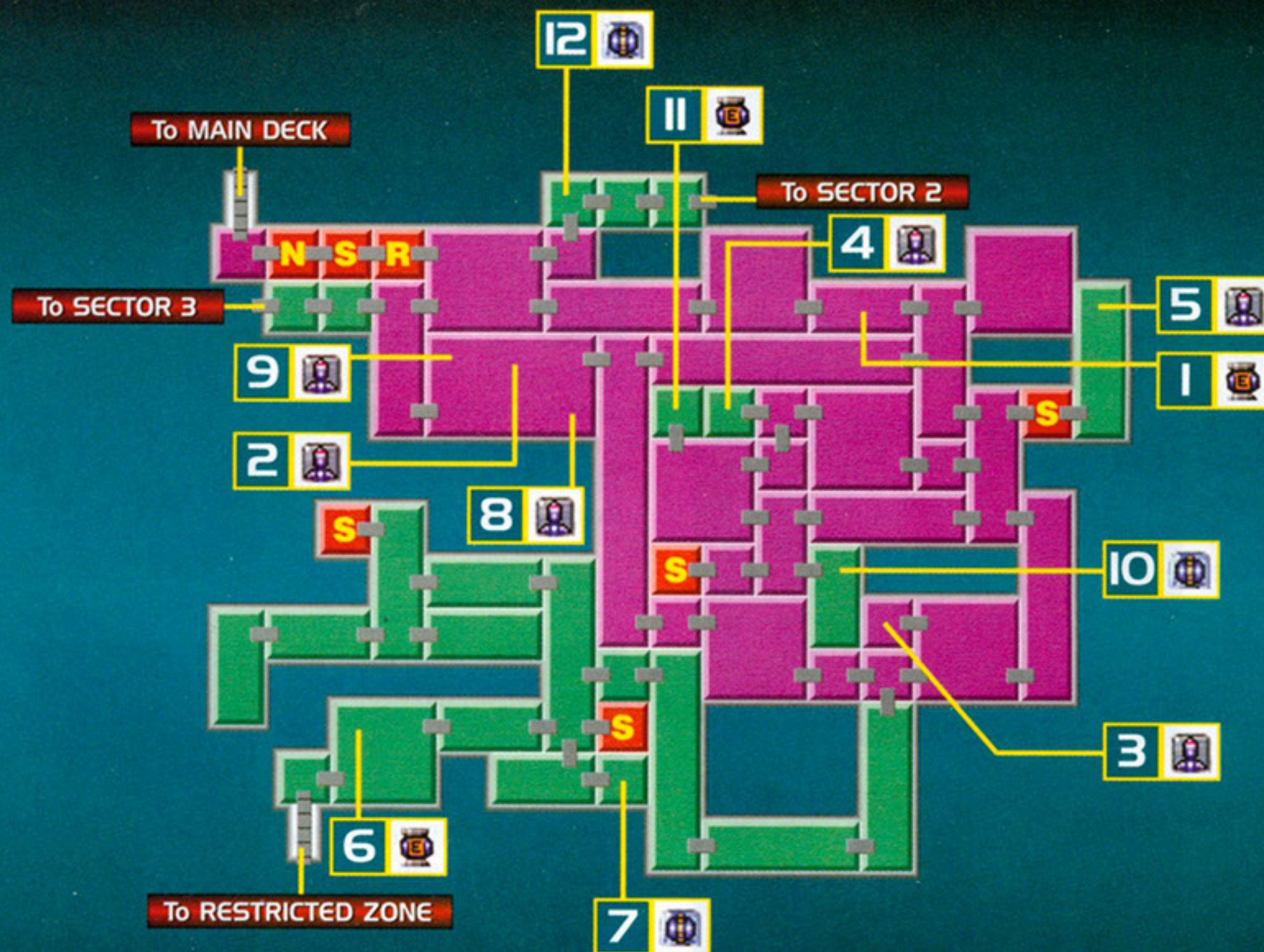

1 On your way to the second stabilizer, you'll find a pipe that runs parallel to the floor. Crouch and fire to destroy an obstacle that blocks the pipe, then morph, roll and collect an Energy Tank.



2 The only item that you can collect in Sector 1's lava-filled room without wearing the Gravity suit is a Missile Tank. Jump up and climb along the ceiling. Then drop and collect the tank.



3 After you fix the fourth atmospheric stabilizer, enter the hatch in the upper-left corner of the area. You'll discover a small alcove that holds a Missile Tank—more firepower for your battle with the Core-X.

4 Before you enter the room that holds the last stabilizer, grab onto a handle on the ceiling and fire Missiles to the left. You'll break through the wall and uncover a passage to a Missile Tank.

5 You'll need the Hi-Jump, and could use the Space Jump, to reach the Missile Tank in the sector's upper-right corner. Roll through a tunnel in the Save Room to a vertical passage. Climb and collect.

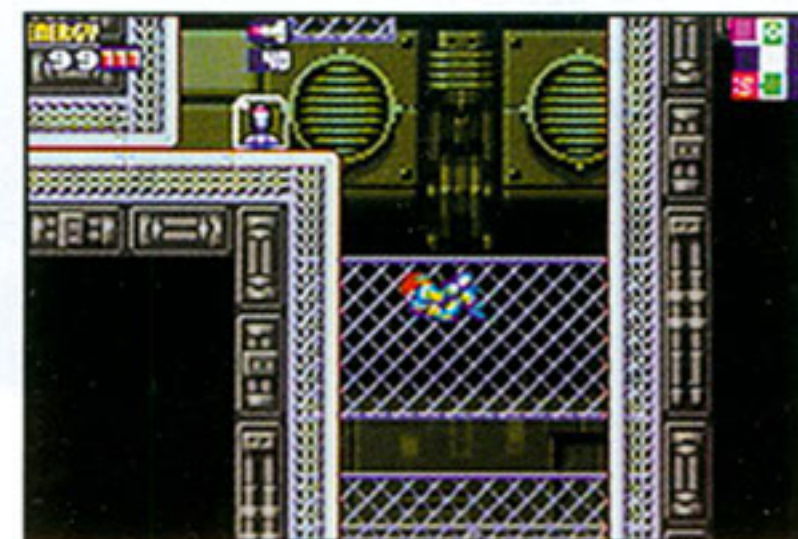

6 On your way back from the Restricted Zone, fire a Diffusion Missile to freeze enemies in the middle of a vertical area. You'll also expose an Energy Tank. Use a frozen enemy as a platform to get to the tank.

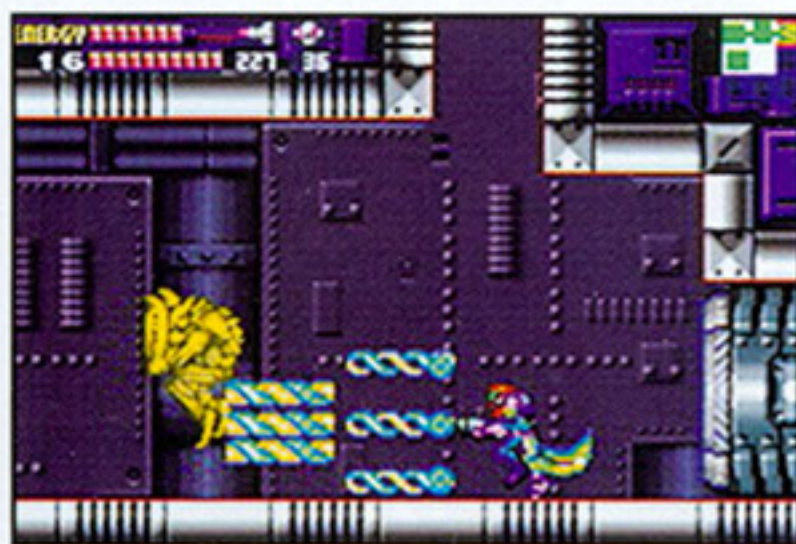

7 Fire a charged Beam at an enemy in an enclosed area and let it re-form into a crab. Hit the crab with a Missile—it will become a gold pirate. Blast the pirate for access to a Power Bomb Tank.

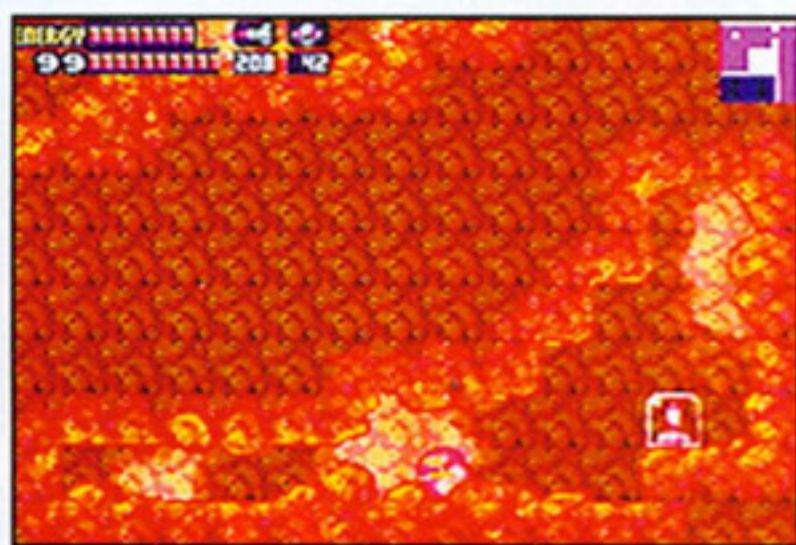

8 9 The Gravity Suit allows you to move freely in lava. Roll into the lower-right corner of the lava-filled chamber, then fly up to the upper-left corner to collect two tanks.

10 The Power Bomb Tank in the lower-right section of Sector 1 will be one of your most challenging acquisitions and will put your Speed Booster skills to the test. Start in the left side of the Save Room, three rooms to the left of the chamber that holds the item. Run to the right without stopping for anything. As soon as you reach the target room, crouch to stop and fire your Wave Beam diagonally down to defeat a wall-crawling creature. While you're still charged, drop to the bottom of the chamber, run to the right side and press A. You'll rocket up, blast through a Boost Block barrier and collect the prize.

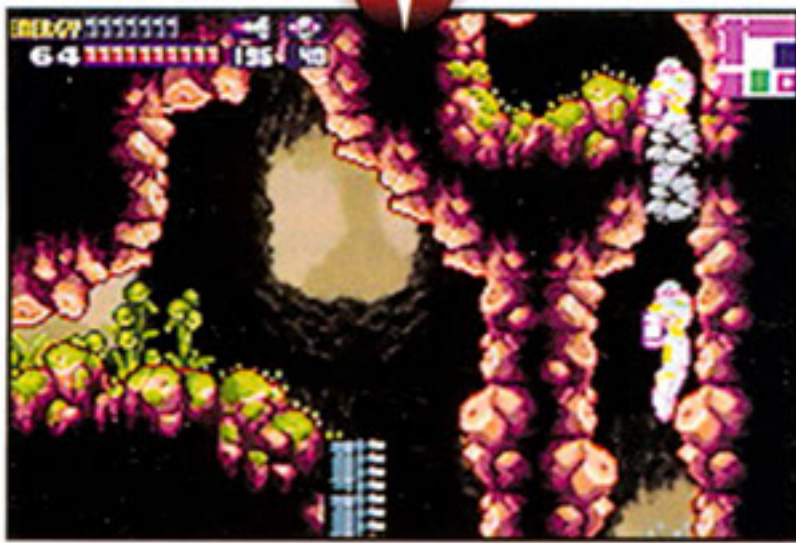
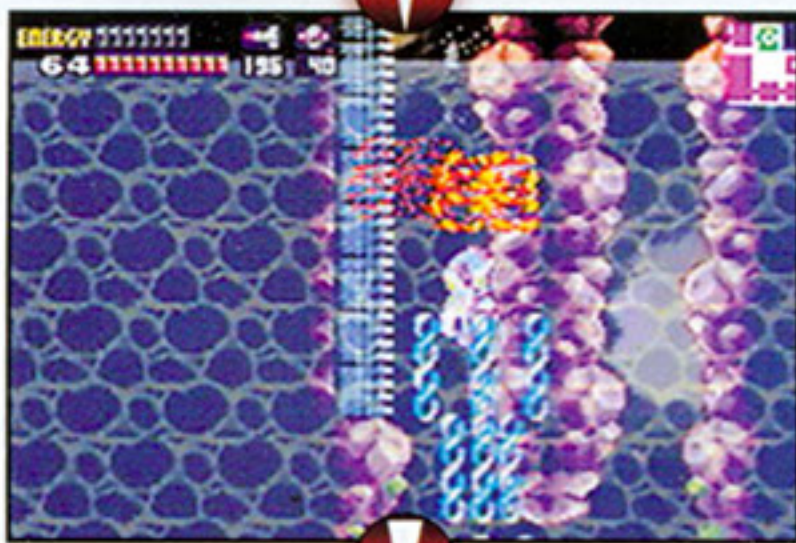
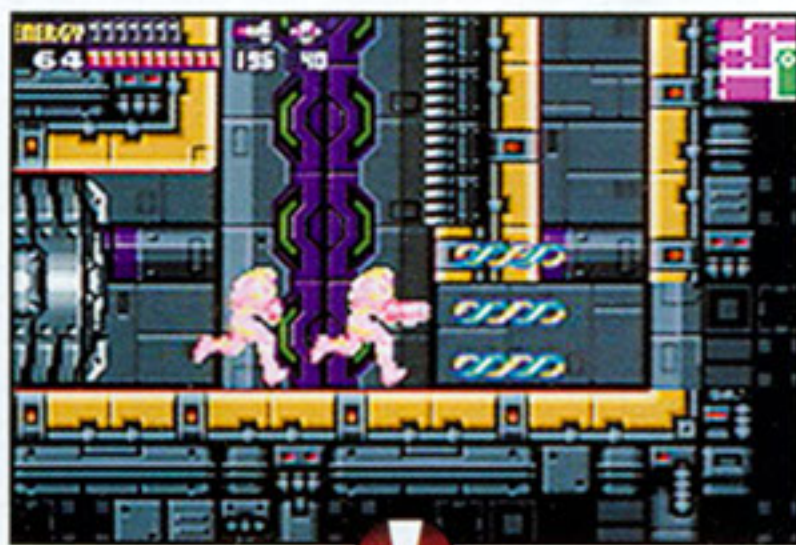

11 You'll need the same skills that you demonstrated while collecting the Power Bomb Tank in the lower-right section of the sector to collect the Energy Tank in the middle. In fact you'll start in the same Save Room. Run to the right to charge your Speed Booster. When you're charged up, crouch to stop, then Space-Jump up the short, vertical section and run to the left until you reach the wall. Stop again, then press A to launch straight up. You'll blast off through a collection of Boost Blocks and hit the ceiling. Press Right to grab a ledge as you fall, then pull yourself up and collect the tank.

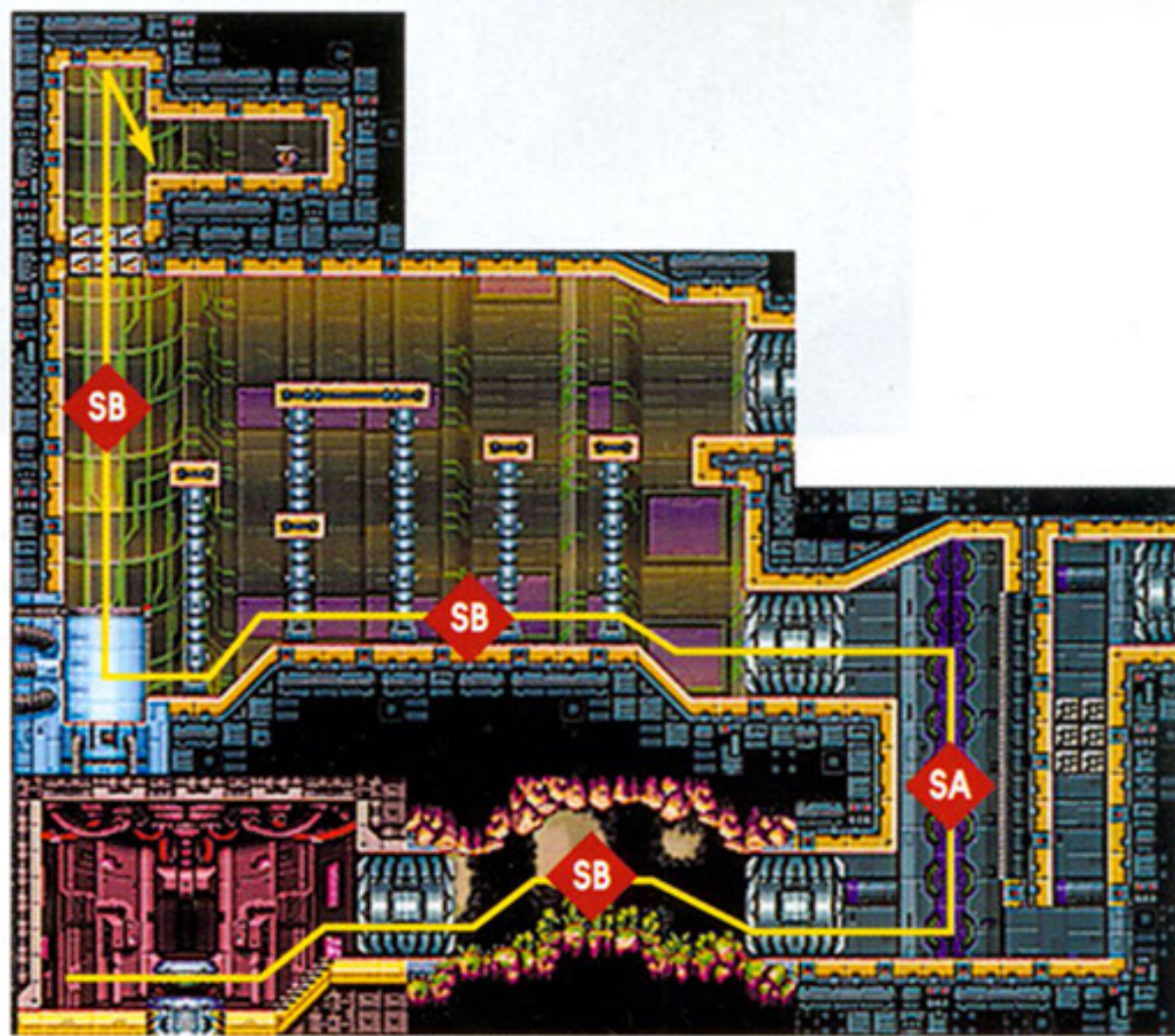
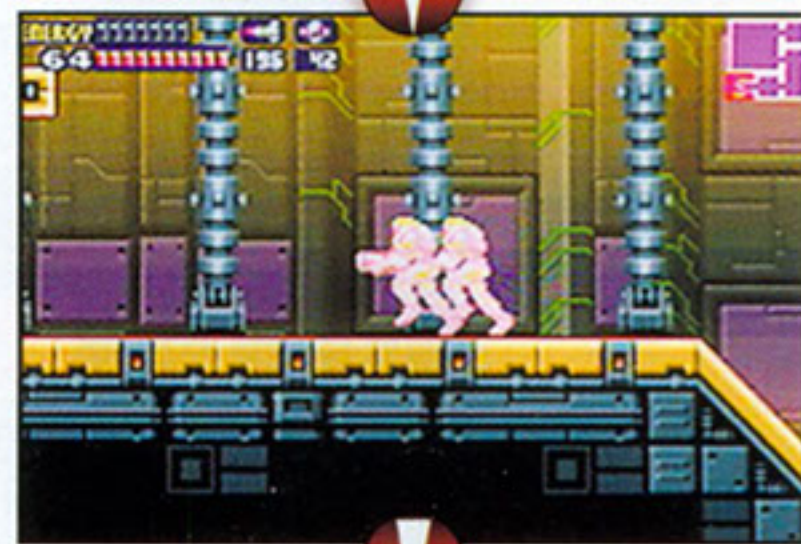
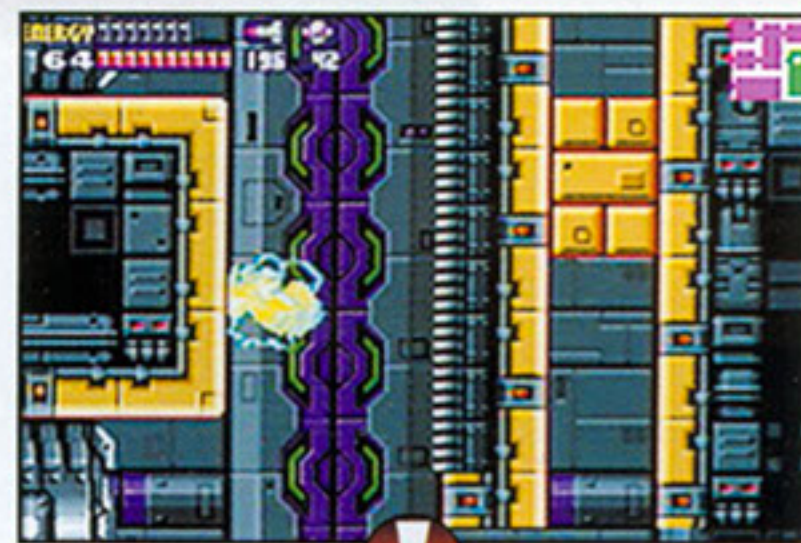

12 You'll find Screw Attack Blocks on the ceiling of the natural habitat room that is closest to the sector entrance. Fly through the barrier, collect a tank and look for a secret exit to Sector 2.



SECTOR 2

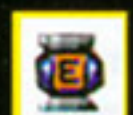

= 3/20



= 9/48



= 5/32

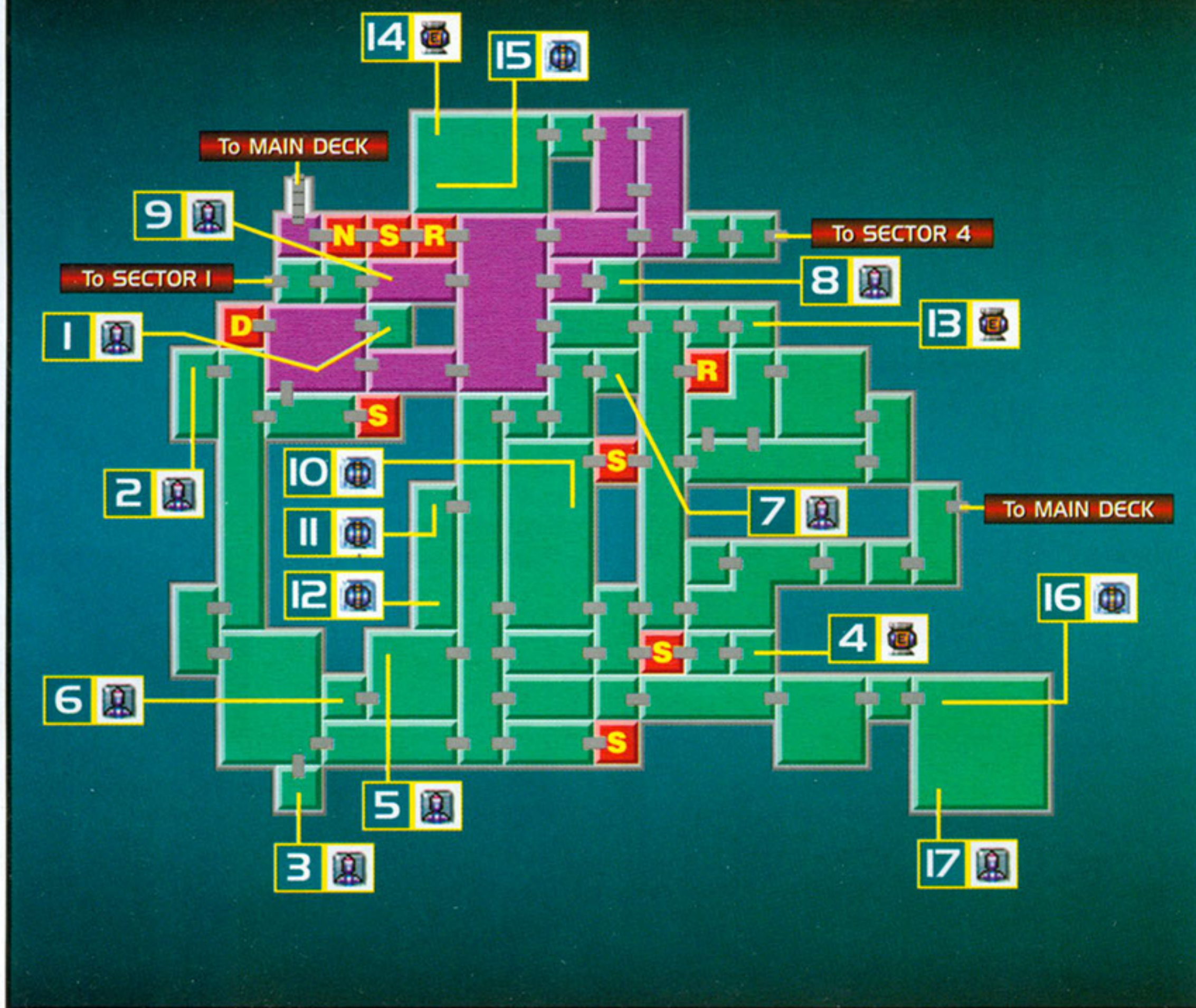

1 After you download the Bomb data and return to the large room that has a blown hatch, jump to a short ledge on the right wall and detonate a Bomb. You'll uncover a passage to an unmapped room that holds a Missile Tank.

2 Before you descend into Sector 2's large, unmapped area, use a Bomb to make a pole rise from a block. Hop to the right, crouch and fire to the left. You'll create a passage to a room that holds a Missile Tank. Create another pole boost there.

3 Drop into the area where the difficult-to-defeat blue creature crawls. Detonate a Bomb against the right step to reveal a tunnel. Roll into the tunnel, place more Bombs and drop to collect a tank.



4 Dead-end exploration pays off. Save your progress, then run two rooms to the right and collect an Energy Tank. Bomb the floor and proceed to a boss battle to earn the Hi-Jump.

5 Once you have the Hi-Jump, you'll be able to reach the ceiling of a large room to the left of the main vertical passage. Grab onto the ceiling and move to the left. You'll find a Missile Tank on a ledge in the room's upper-left corner.

6 Drop into the tank and bomb the floor to make a pole rise. Hop onto the pole, jump over a wall and enter a room where you'll make another pole appear. Hop from the pole in ball form and detonate a bomb against the wall for passage to a tank.

7 As you make your way back to the known areas of Sector 2, you'll zigzag up a vertical section by jumping from ledge to ledge. Roll along the right ledge and bomb the wall to enter a passage that leads to a Missile Tank.

8 You'll go through a Level 1 hatch to reach a room full of spiked creatures that crawl on the walls and ceiling. Clear away the creatures, then blow open a hole in the middle of the right wall and roll to a tank.

9 Tall, plantlike beings populate the corridor under the sector's first Save Room. Once you have the Hi-Jump, you can leap over the plants and collect a Missile Tank that rests on a ledge at the left end of the corridor.

10 Destroy the blocks directly below the top ledge in the huge room at the center of the sector's unmapped area. You'll open a path to a Power Bomb Tank.

11 12

Once you've restored the power, you can enter a tall chamber that holds two tanks. The blocks will crumble under your weight. The only way to get to the tank in the upper-left corner is to freeze enemies and use them as platforms. Hang from the ceiling and fire down to freeze the first one, then drop and freeze the second one. After you hop to the tank, you'll fall through the wall to the other tank.



13 After you defeat the enemies in what appears to be a dead end, jump against the right wall and press Right on the Control Pad. You'll find a passage that leads to a tank.

14 15

You can use the Screw Attack to blast through the upper-left wall of the Sector 2 Security Room and enter an area that holds two tanks. You'll have to navigate the area by way of the Space Jump technique—many of the blocks will fall apart when you land on them. Use Power Bombs in the area to expose all of the breakaway blocks, then avoid them as you fly.

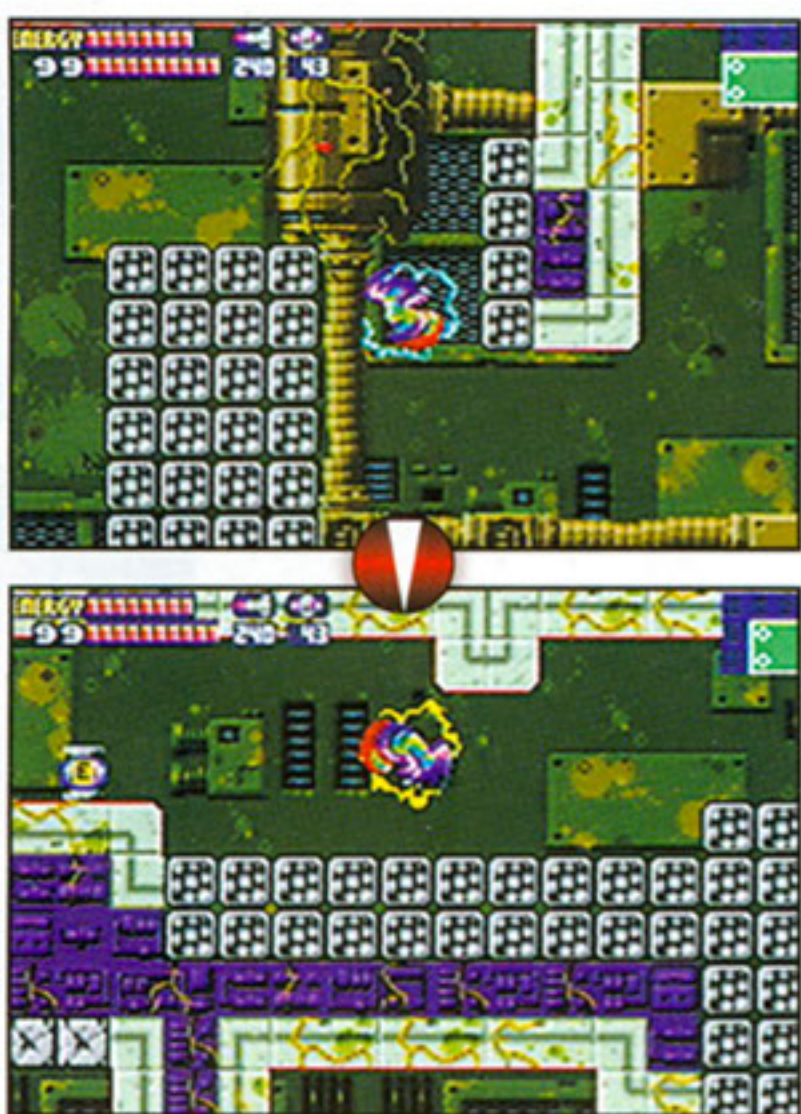

16 You'll find Screw Attack Blocks in the upper-right corner of the boss arena in Sector 2. Fly through the barrier and make your way to a room that has several levels, largely comprised of breakaway blocks. The only way to get to the Power Bomb Tank in the chamber's upper-left corner is to demonstrate perfect mastery of the Speed Booster. Run from left to right on the floor, then crouch to stop when your booster is charged. Space-Jump up to the ledge and press A as you press Left to run, in a charged state, over the first section of false blocks. Crouch to stop at the end and repeat the process as you zigzag up to the top of the room.

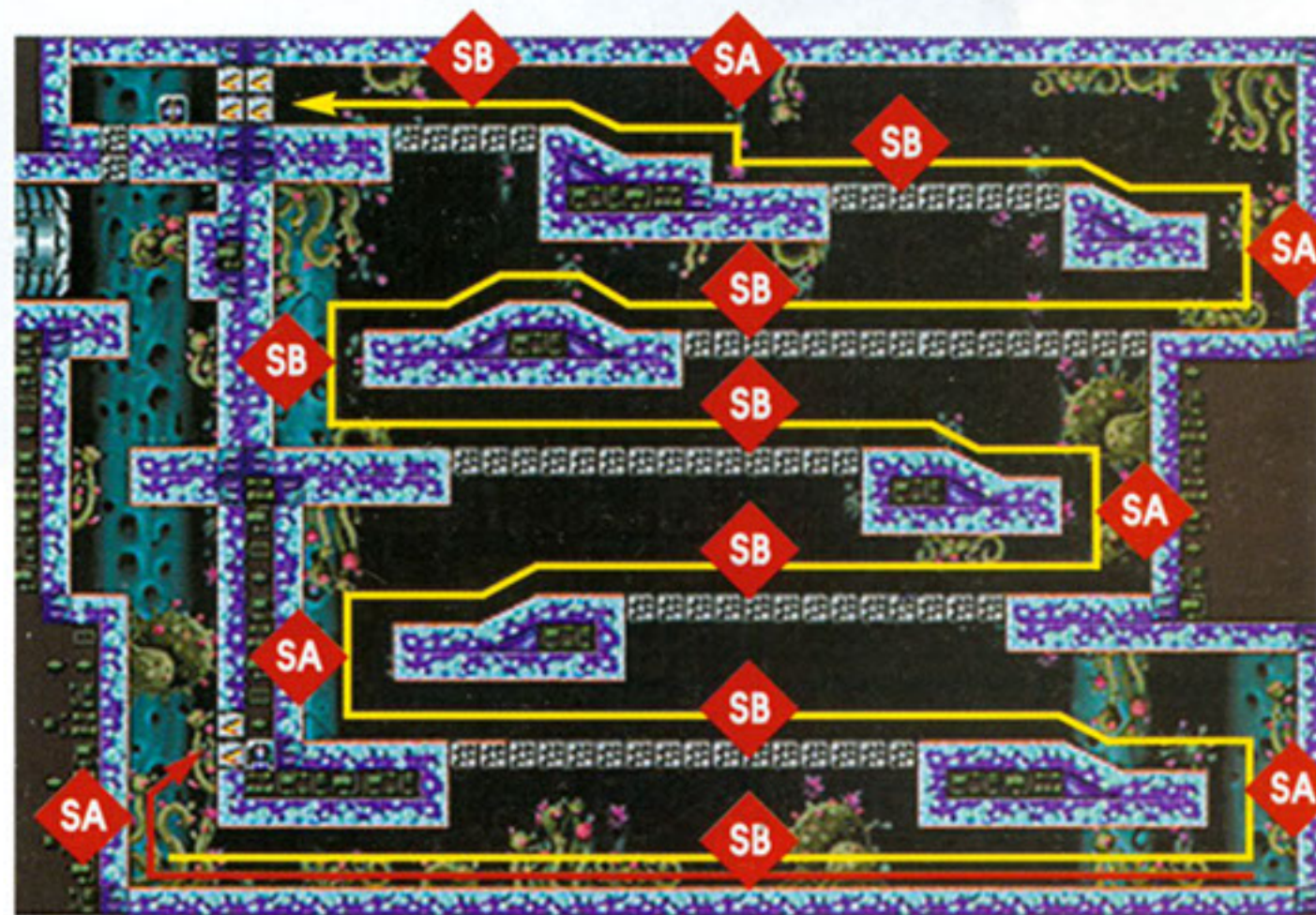
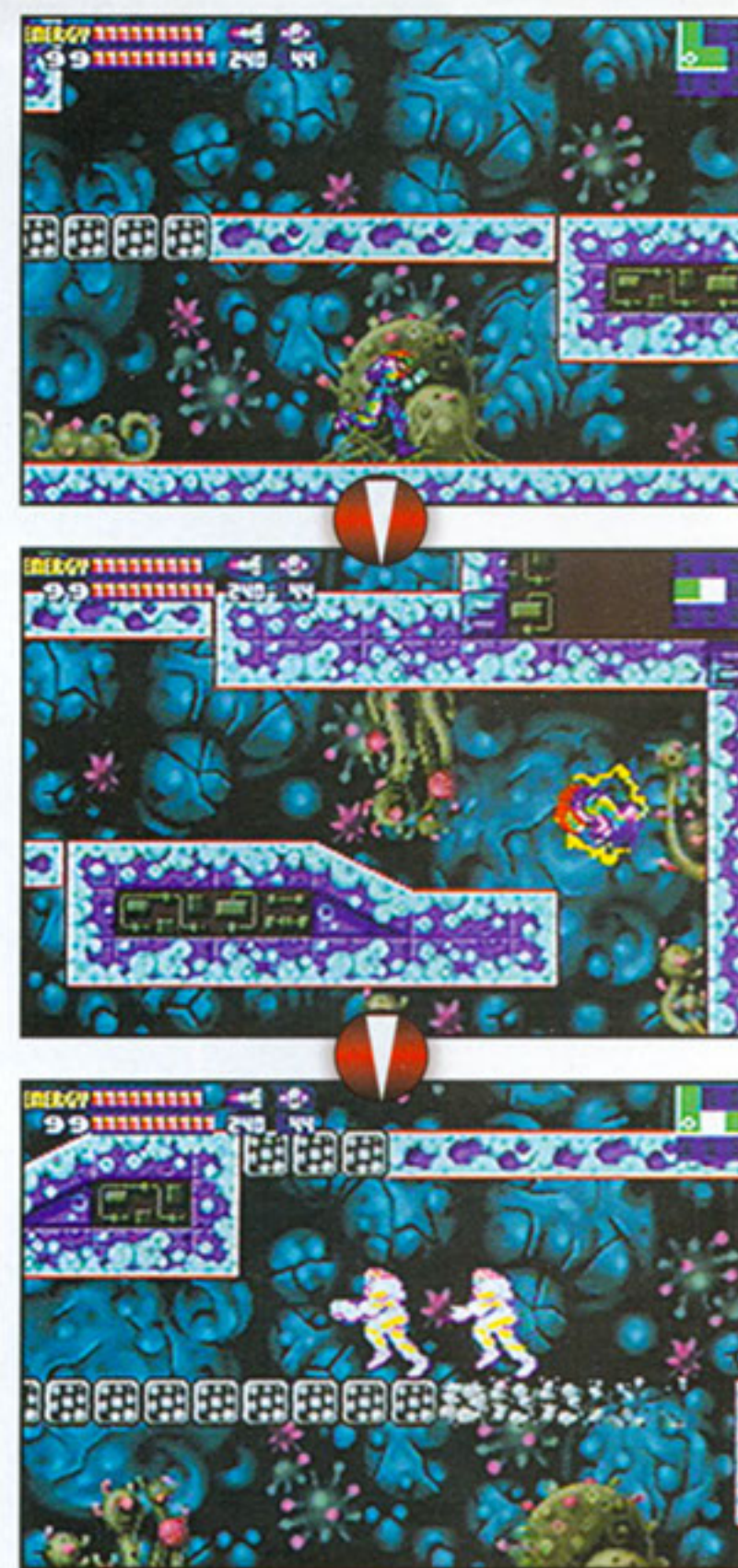

17 Run along the floor from right to left to charge your Speed Booster. Stop at the wall, get some height using the Space Jump, then straighten out, fall and press A then Right to launch into a Boost Block barrier. You'll collect a Missile Tank on the inside.



SECTOR 3



= 3/20



= 7/48



= 6/32

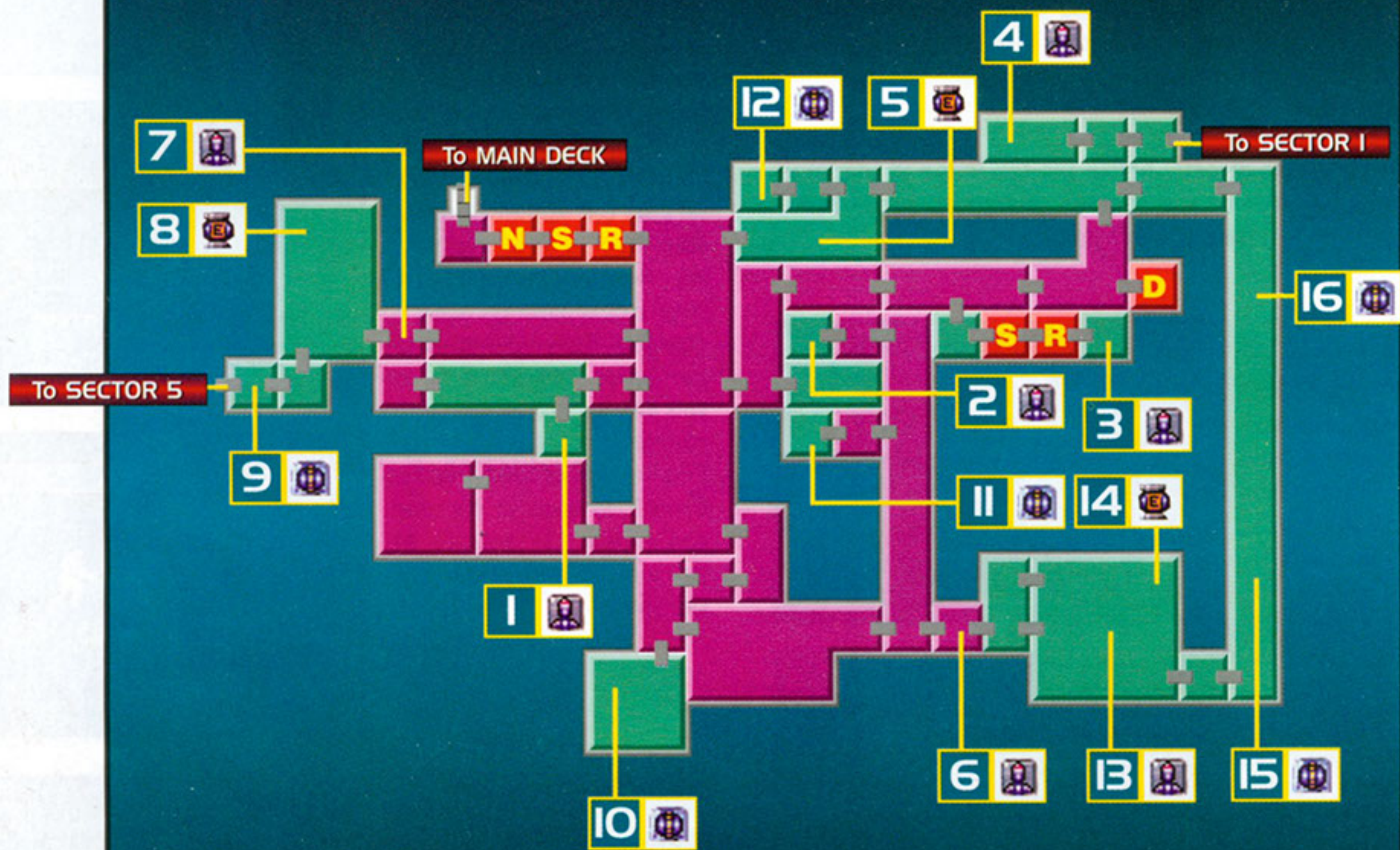

1 Bomb the floor left of the Boost Block barrier in the long corridor to uncover a hole. Drop into a small room and expose a Missile Tank by firing at the ceiling in the right corner.



2 As you're heading up to the desert environment, you'll find two tunnels in a wall. Take the higher tunnel and roll left, into a Missile Tank. You'll need the Missiles for your battle with the Security Robot.

3 As soon as you earn the Super Missiles, you'll put them to the test. Use the powerful rockets to destroy a living barrier in the room to the right of the Recharge Room. You'll gain access to a Missile Tank.

4 After you defeat the Security Robot and climb its wreckage, jump to the left and aim your Beam at the ceiling. You'll expose a Missile Tank on the other side of a Boost Block barrier. Drop and run along the path to the left, then turn, run to the right and charge up your Speed Booster. Crouch to stop at the hole. Press A, then press Up and Left on the Control Pad to rocket through the barrier.

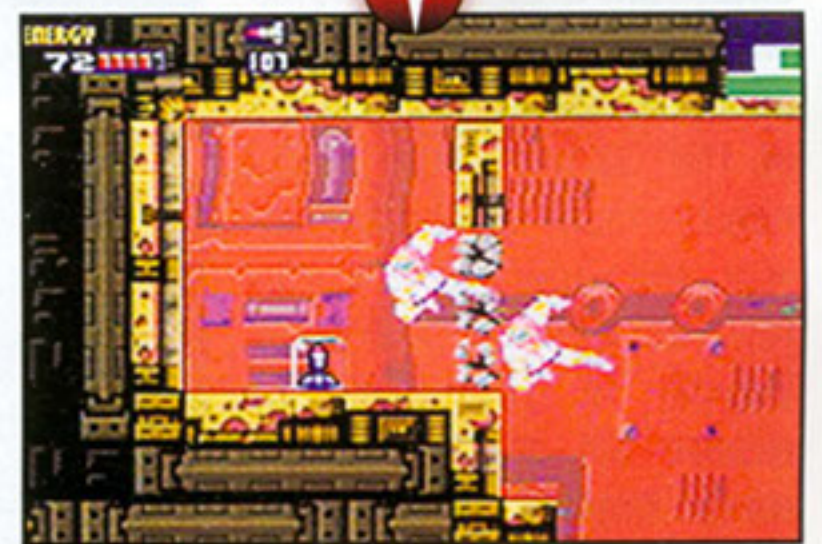

5 When you reach an assembly of blocks that hang from the ceiling, bomb the floor and rise with a post. Then hop in ball form and blast the two blocks directly above you to reveal an Energy Tank.

6 You'll discover a large rectangular object in a small room. Defeat all of the spiked enemies, then jump onto the object and bomb the top of it to reveal a Missile Tank.

7 Once you have the Varia Suit, use it to brave the high temperatures of the corridor that is flooded with lava. Grab onto the grips on the ceiling, make your way to the left end and discover a Missile Tank in the next room.

8 Clear a long runway, then run from right to left to charge your Speed Booster. Crouch to stop, then launch straight up. Land on a ledge, bomb your way to the right side of the room and make a pole rise up. Then work your way around to a tank.

9 Detonate a Power Bomb in the right end of the tunnel that connects Sector 3 to Sector 5. You'll create a hole in the ceiling. Jump through the hole, roll to the right and grab a Power Bomb Tank.



10 After you bomb your way into the lava-filled room that holds a Power Bomb Tank, roll through a hidden passage to reach the upper-right corner, then work your way around the room to the tank.



11 Detonate a Power Bomb in the room that has Boost Blocks on the ceiling to open a passage in the upper-left corner. The passage leads to a room that has a long-necked creature on the wall and a Power Bomb Tank in the corner.

12 You can reach the area to the right of the room that holds the area's Power Bomb Tank from two different angles. Use your Speed Booster charge to break in to the area from the right side, or use Bombs to break in from below. Once you're in the area, detonate a Power Bomb to reveal a passage near the top of the left wall. Grab onto the ledge, roll to the left and collect the tank.

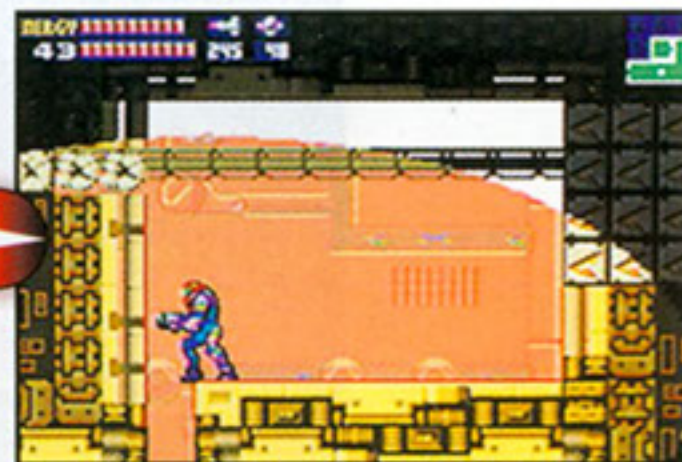
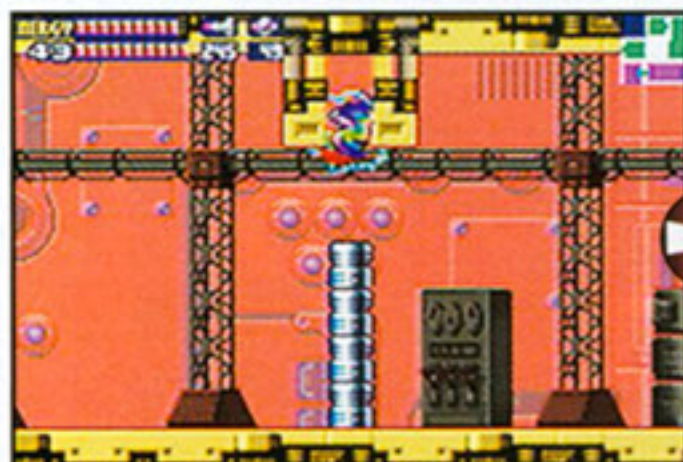

13 14 Most of the platforms in the large lava chamber are made of breakaway blocks. You can reach the solid ledge in the upper-right corner by freezing the enemies that populate the platforms and using them as steps. If you have the Space Jump upgrade, you can reach the ledge with a long, diagonal flight. Once you grab the ledge, pull yourself up and roll over to a pair of tanks.





15 16 Use the Screw Attack to clear a runway in the large lava room. Then run from left to right to charge up your Speed Booster and crouch to stop at the wall. As you rocket up through a narrow vertical passage, you'll grab a Power Bomb Tank. After you reach the top, fall down and grab onto the first ledge to the left. Detonate a Power Bomb to reveal two sets of Screw Attack Blocks in the ceiling, on either side of a wall. Break through the blocks and grab another Power Bomb Tank.



SECTOR 4

 = 2/20

 = 9/48

 = 4/32

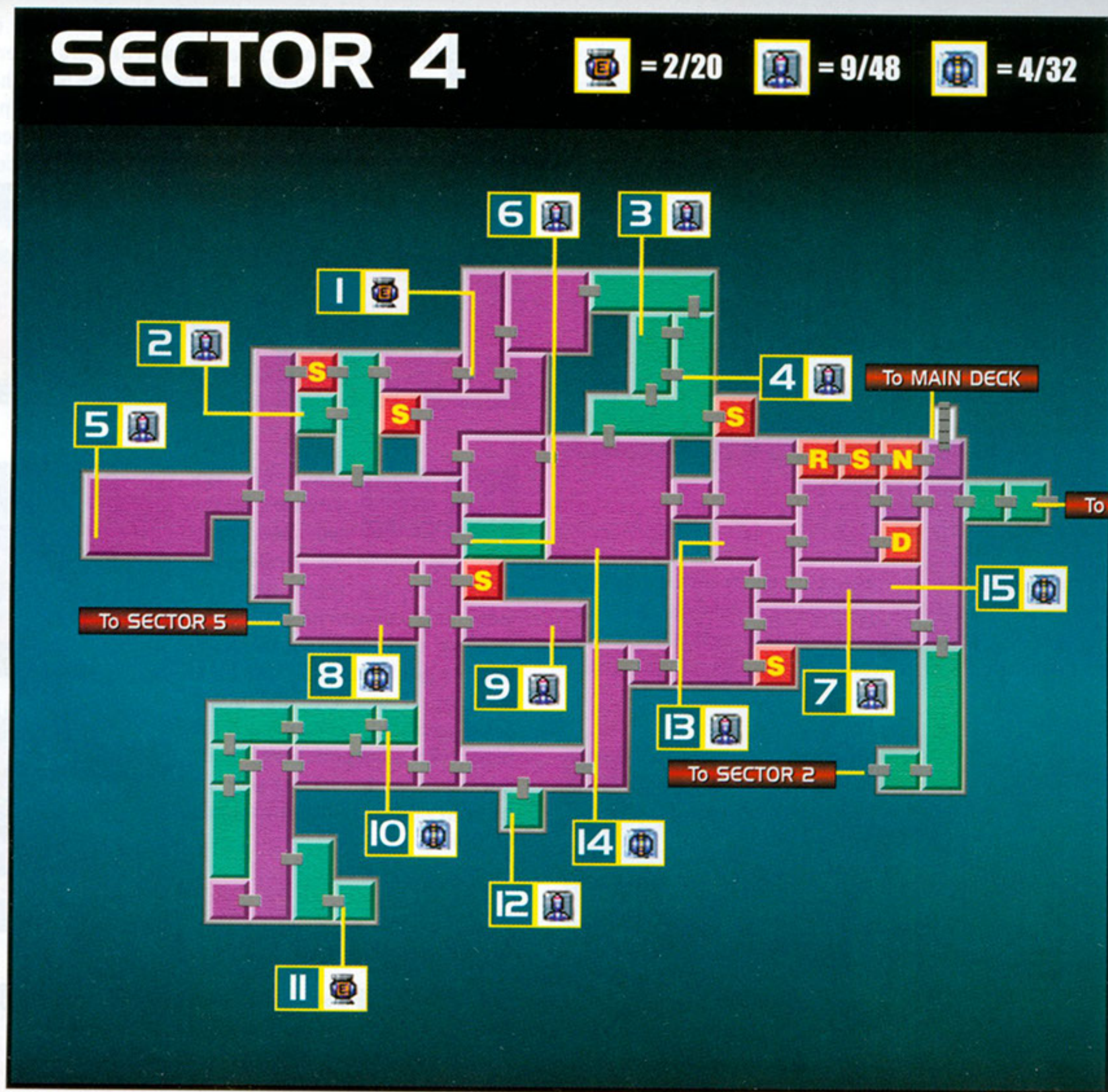

1 When you reach the room with water tanks, jump over both tanks and follow the path to an Energy Tank to the right side of some wreckage. Then backtrack to the room with the tanks and go through the hatch in the lower-left corner.

2 After you cross over the electrified water, follow the path up and climb a ladder on the left wall. When you reach the top of the ladder, continue to press Up on the Control Pad. You'll roll into a passage that leads to a Missile Tank.

3 After you use the Speed Booster to make a hole in the floor of an unmapped section, drop then climb to a short ledge. Bomb open a passage, roll to the left and use Bombs again to expose a tank.

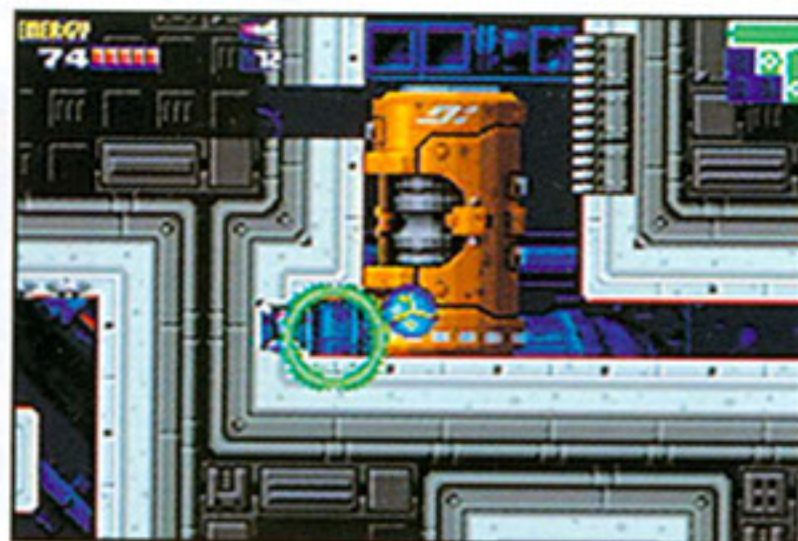

4 Use Missiles to open a passage close to where you found the last tank. Follow the passage left, down and to the right. Roll to a ledge, jump up and break through the right wall to find a Missile Tank.

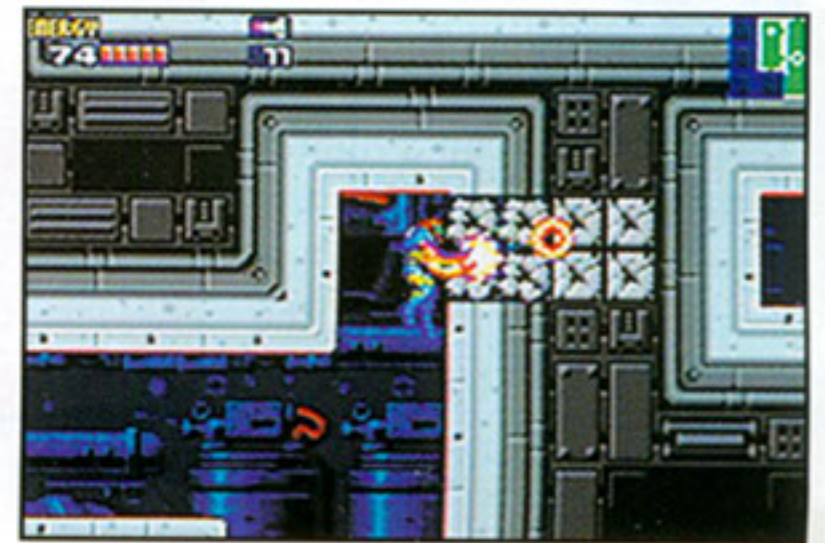

5 Immediately after you lower the water level in Sector 4, jump to the ladder on the left wall, climb down and jump to a ledge on the right. Morph, roll and collect a Missile Tank.

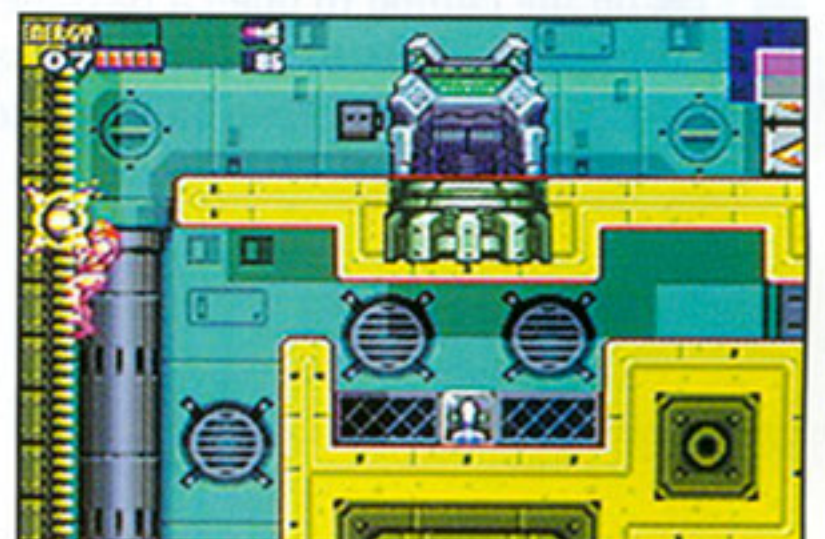

6 You'll find a Missile Tank in an unmapped area between drained tanks. Charge up your Speed Booster inside either tank and crash through a Boost Block barrier to make your way to the prize.

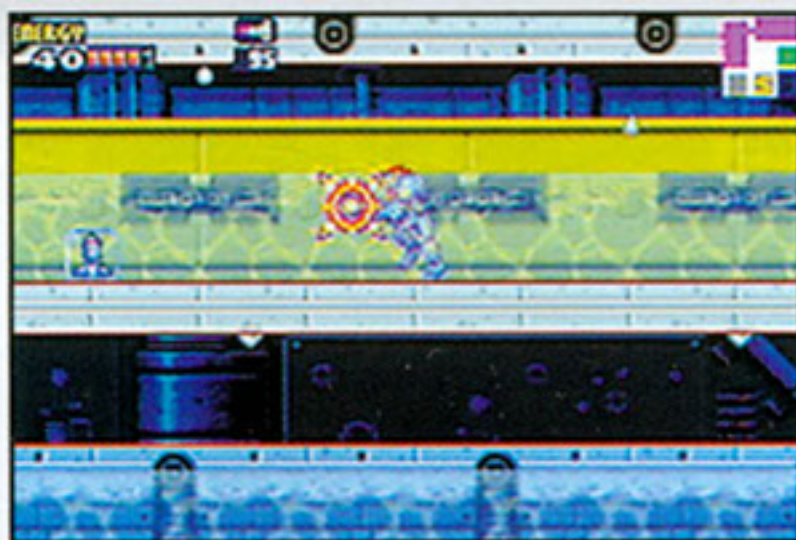

7 Before you leave the sector at the end of your first visit, you can drop into a deep-water area then collect a Missile Tank in a room that is filled with small—but tough—enemies. You'll need the Screw Attack to go any farther.

8 After you enter Sector 4 from Sector 5, you'll blast through a Boost Block barrier and open a hatch to a vertical passage. Drop down and find a hidden hole in the left wall that will lead you to a tank.



9 You can defeat the small, shell-protected creatures in the long water hall by hitting them with charged Plasma Beam shots. When you get to the end, you'll find a Missile Tank.

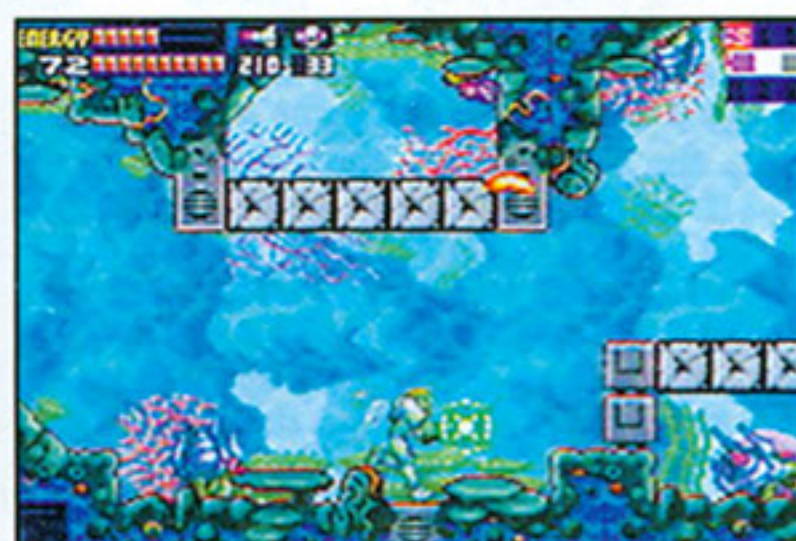

10 After you use a Power Bomb and Missiles to break through the ceiling of the water tunnel, climb up to the next enclosed area and use another Power Bomb to reveal the passage to a tank in the upper-right corner.

11 You'll find a hidden passage into an area that has several crablike enemies. Hit them with a Power Bomb blast and let them re-form into gold crabs. Defeat the new enemies to open a hatch. Enter, detonate a Power Bomb and collect a tank.

12 Break the floor of a water tunnel with a Power Bomb blast, drop into an enclosed area and collect a Missile Tank. Defeat the enemies and Space-Jump back to the tunnel.



13 After you collect the Diffusion Missile data, freeze the inflatable enemies and move on to a room to the left with exposed wires. Use a Power Bomb to uncover a tank.

14 Circles on the computer's map indicate tanks that you haven't collected in rooms that you've already explored. You may find a circle that marks one of the large rooms with exposed wires. Enter the room's right hatch and detonate a Power Bomb to reveal a tight passage at ground level. Roll to the left and drop into a lower area. When you reach the bottom of the drained pool, detonate another Power Bomb. You'll find a tunnel in the lower-left corner that leads to a Power Bomb Tank. If you're trying for the best ending, you'll have to find every last tank. Keep searching.

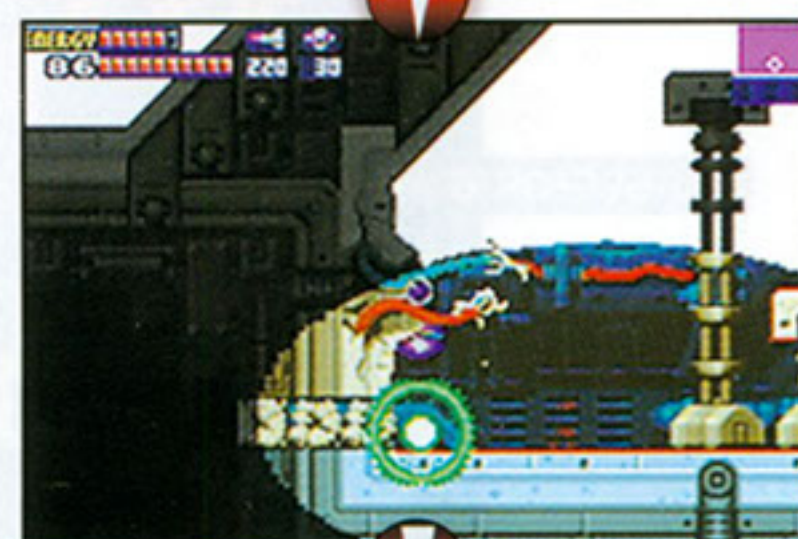
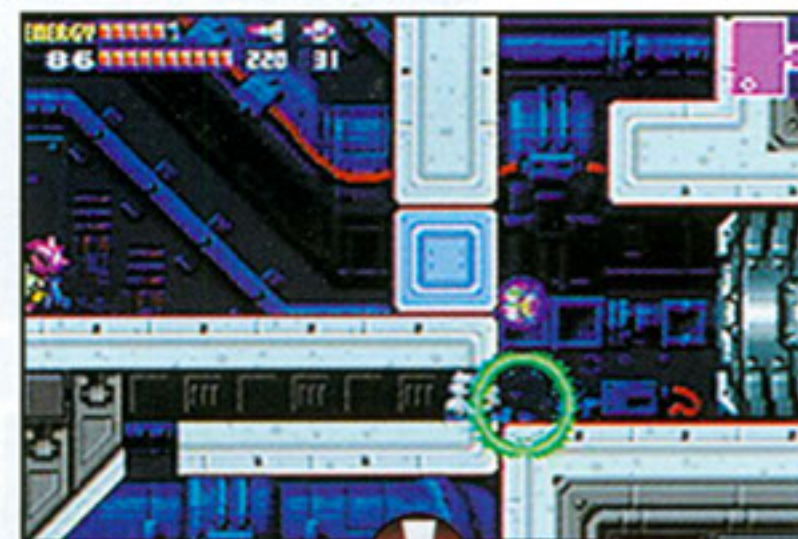

15 You'll find a long, straight water section directly below the sector's lower-right Power Bomb Tank. Clear the area of enemies, then run through the section from left to right to charge up your Speed Booster. Crouch to stop before you reach the right hatch, then position yourself under a gap between rocks in the ceiling and press A to rocket straight up to the tank. After you hit the ceiling, drift to the right and collect the item.



SECTOR 5



= 3/20



= 4/48



= 8/32

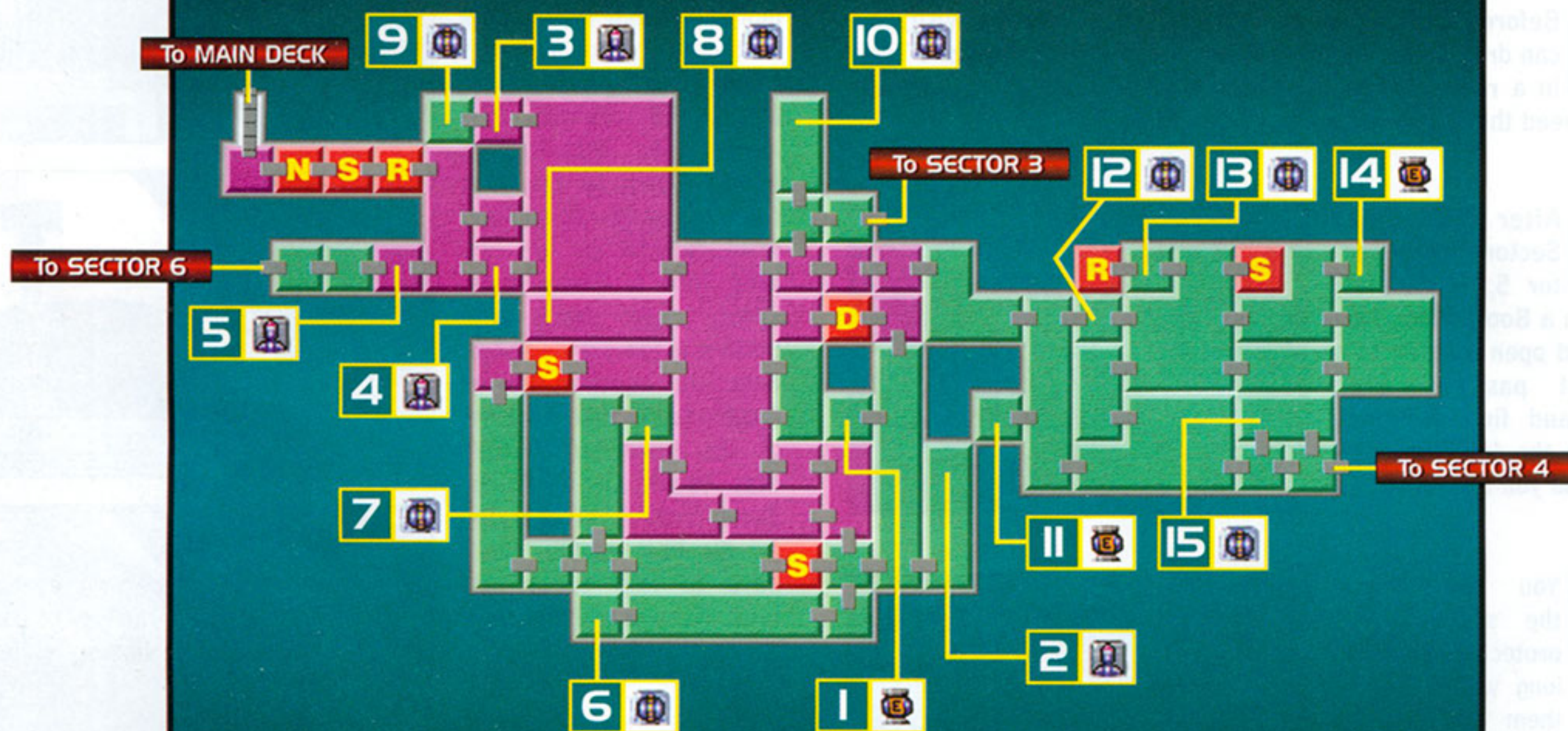

1 Climb the right wall of the long shaft, freeze a floating enemy with an Ice Missile and use it as a platform as you jump to the left. You'll fight off a false tank then expose a real one by using Bombs.

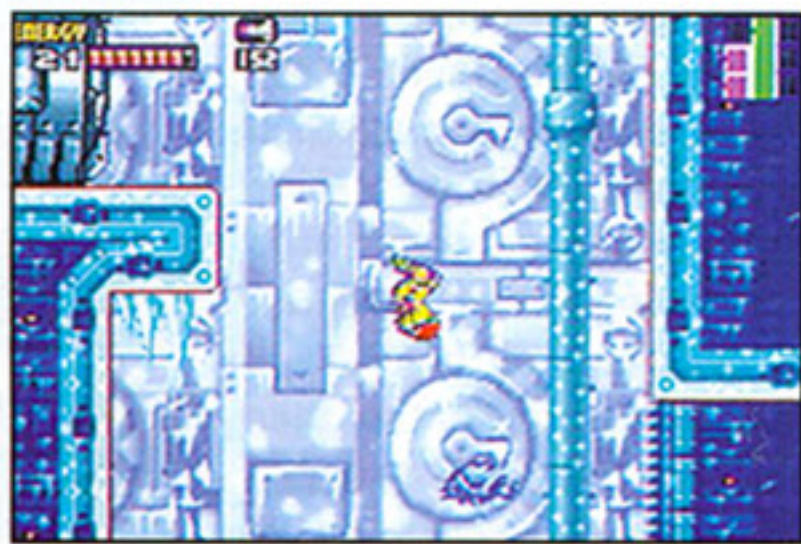

2 When you reach the bottom of the long shaft, roll into the lower-right corner and hop through a hidden passage to another shaft. Run to the right side and fire straight up to expose a hole. Jump up to the ledge and defeat an enemy, but don't collect the parasite. Let it form into another creature. Freeze the new enemy in the air and use it as a platform. Jump up to the next ledge, defeat another enemy, freeze the reformed creature and hop onto it for access to a Missile Tank in the ceiling.

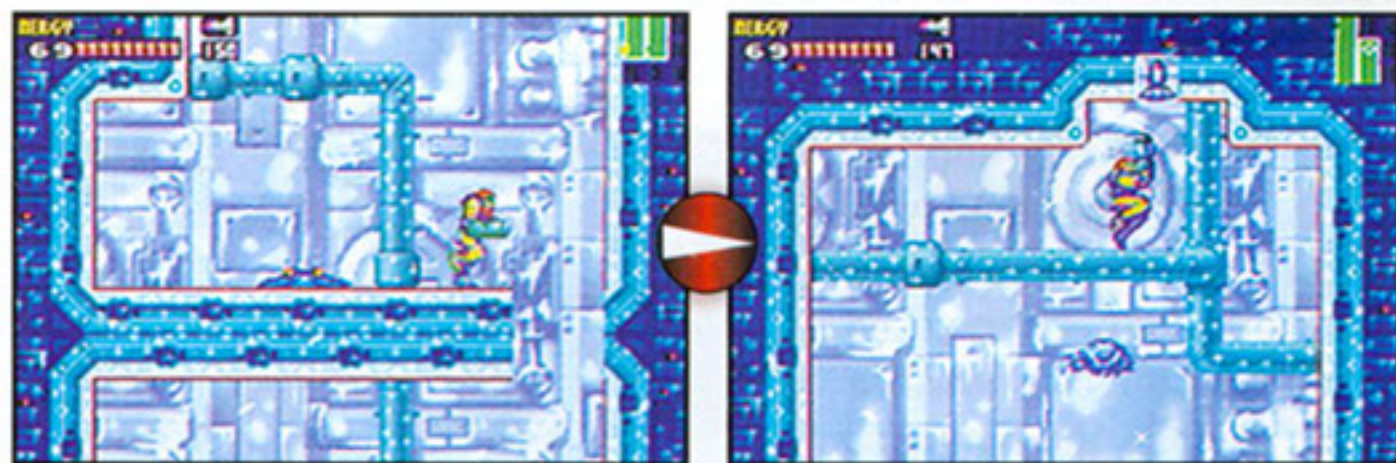

3 You can make your way up the left side of the tall chamber by freezing the floating enemies in midair and using them as platforms. After you get to the top, move left and collect a Missile Tank in the next room.

4 After you defeat the large creature that inhabits the small connecting room, hop up in ball form and plant a Bomb in the upper-right corner. You'll expose a Missile Tank. Jump, grab the ledge, pull up and roll to collect it.

5 You'll discover a Missile Tank in an enclosed area. Defeat the enemies in the room, then roll just right of the enclosed area's lower-left corner and hop up through a hidden hole. Roll to the right and collect the tank.

6 Following your Power Bomb data download, you'll drop then bomb your way down to the lower sector and run from the SA-X. At the end of your run, you'll find a Power Bomb Tank.

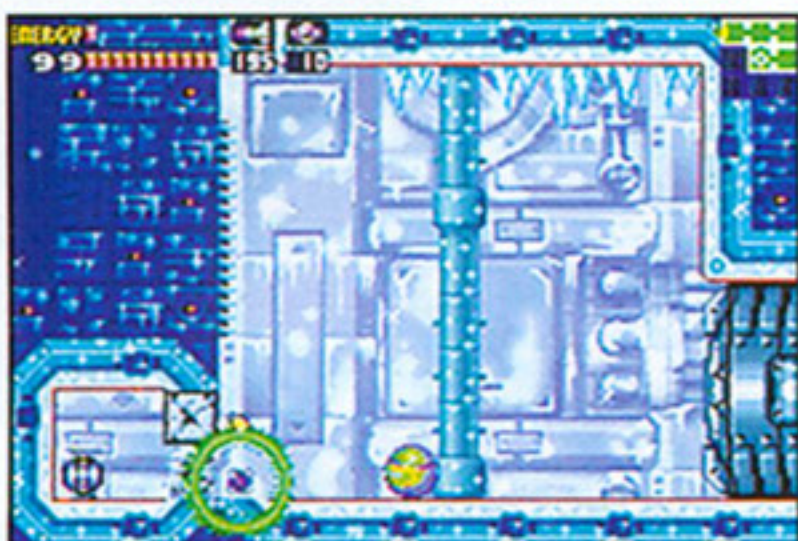

7 After you collect the first Power Bomb Tank, climb up and use one of the large explosives to open a vertical passage. Hit enemies with Ice Missiles and use the frozen creatures as platforms as you ascend the passage and discover another tank.

8 Enemies slide back and forth over breakaway blocks in a long hall. Freeze the enemies and roll over them to avoid falling through the blocks. Use a Power Bomb if you want to expose the blocks.

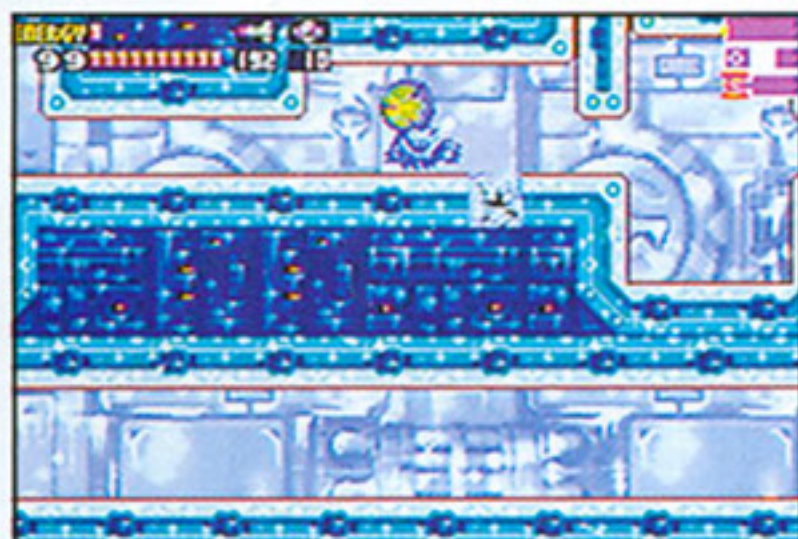

9 After the explosion in Sector 5, you'll have a clear runway to charge your Speed Booster at the top of the large chamber. Run from right to left, then stop and launch to the left. You'll rocket to a Power Bomb Tank.

10 Use Power Bombs to create holes in the floors of the tall chamber near the top of the sector and defeat the tough Zebesian Space Pirates as you climb. One of the holes is only one block wide. Look for it on the right side. When you reach the highest point, you'll see that two shutters block the path to the Power Bomb Tank. Open the one on the right first, then the one on the left. Jump, roll and collect.



11 Use a Missile to break into the room that holds an Energy Tank. Find a hidden path in the left side of the top ledge and roll to the tank as you hop over the breakaway blocks.



12 After you clear away all of the small enemies in one of the devastated rooms above the waterline, use a Bomb in the room's lower-left corner to expose a Power Bomb Tank.

13 Use a Power Bomb near the hatch that leads to the Save Room to expose a tunnel to the left. Roll along the tunnel and hop into a hidden path that will lead you to a tank.



14 On your way to the Nightmare, after you open the eyeball hatch, detonate a Power Bomb to reveal an alternate path to the room's Energy Tank. Roll into a ball, hop up, collect the tank then drop into the boss arena.

15 You'll need the Gravity Suit to charge your Speed Booster in the water. Run along the long corridor in the lower-right section of the sector and blast through two Boost Block barriers. While your booster is still charged, crouch to stop, then position yourself between the broken barriers and press the A Button. You'll rocket straight up to a Power Bomb Tank.



SECTOR 6

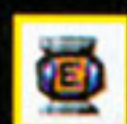

= 3/20



= 6/48

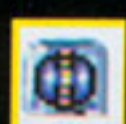

= 3/32

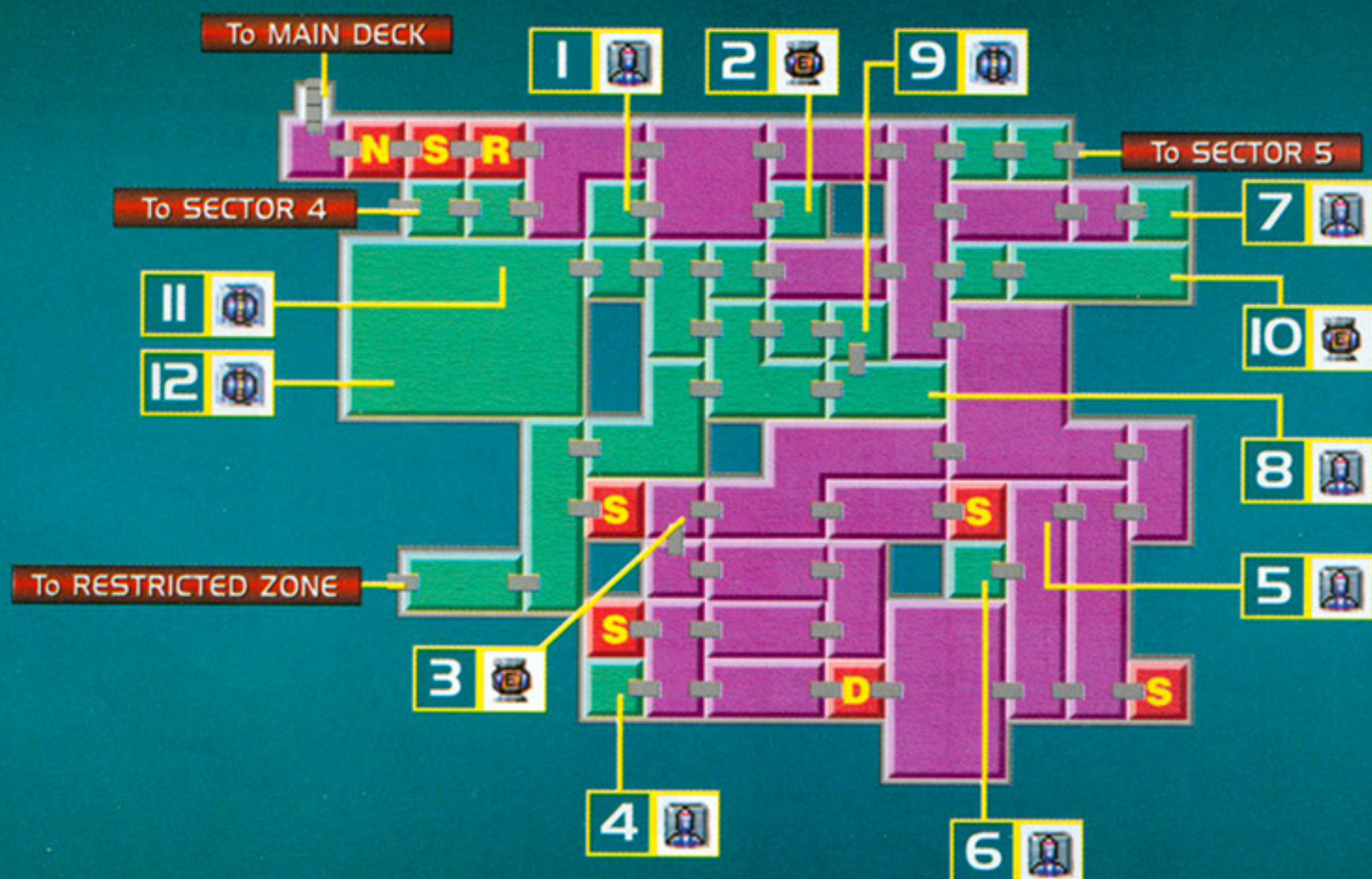

1 Drop to the lower-left corner of the first nocturnal section of Sector 6, hop up and bomb the wall. You'll create an opening to a room that contains a Missile Tank.

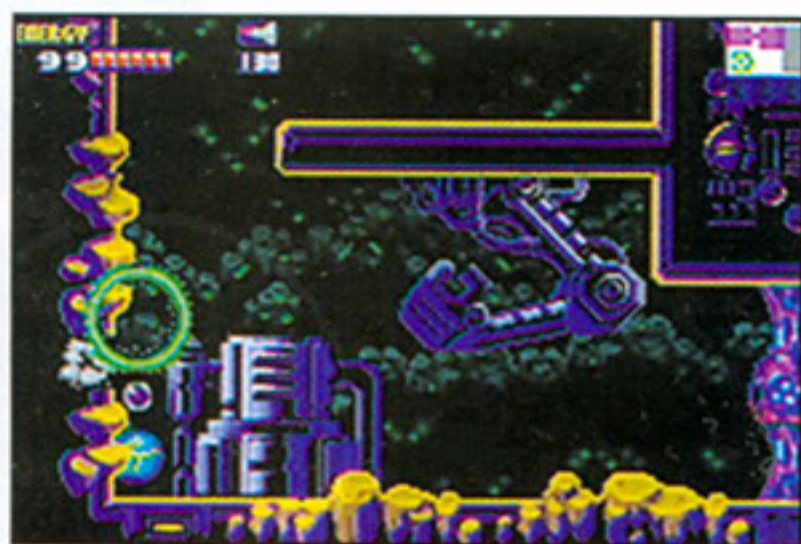

2 Bomb the wall in the lower-right corner of the first nocturnal section and roll to a room with an Energy Tank. You can create two tunnels in the room's wall. In ball form, hop from the ledge, then set a bomb and take the higher tunnel to the tank.

3 The Energy Tank in the lower-left section of Sector 6 is so easy to collect, it may make you suspicious. Don't leave after you take the tank. Detonate a bomb where you found it instead, and drop into a hidden tunnel.

4 In the lower-left section of the sector, you'll find a room where blue X parasites hide in blocks. Make your way to the lower-left corner of the room and detonate a Bomb to reveal a path to another room. Defeat all of the wall-crawling creatures in the new room, then jump up to the ledge, roll to the left and use two Bombs to uncover a Missile Tank.



5 **6** After you climb up a long, vertical passage, run to the left and jump over a false block to a Missile Tank. You'll fall through the floor as soon as you collect it. Press Left on the Control Pad while you're in the air to grab a ledge, then pull up and roll through a hole. Defeat the enemies, shoot Beams at the ceiling and expose another tank.

7 As you explore the upper-right section of the sector, you'll find what looks like a Missile Tank. Approach it with caution. When you get close, it will sprout wings. Defeat the creature, then bomb the wall to find a real tank.

8 Immediately after you defeat the Security Robot to earn the Wave Beam, run to the right and use the Beam to open a shutter. You'll collect a Missile Tank on the other side.

9 After you use the Screw Attack to reach the room, use a normal Bomb to open a passage near the ceiling, then use a Diffusion Missile to freeze an enemy over the breakaway blocks.



10 You'll discover an Energy Tank on the other side of a series of Boost Blocks on the right end of a long passage. Before you can charge through the barrier, you'll have to create a runway. Place Bombs at the points shown in the map section below to make horizontal poles pop out and connect the platforms. If you put a Bomb in the wrong place, a vertical pole will appear and block your way. Leave the room, then return to reset the puzzle.

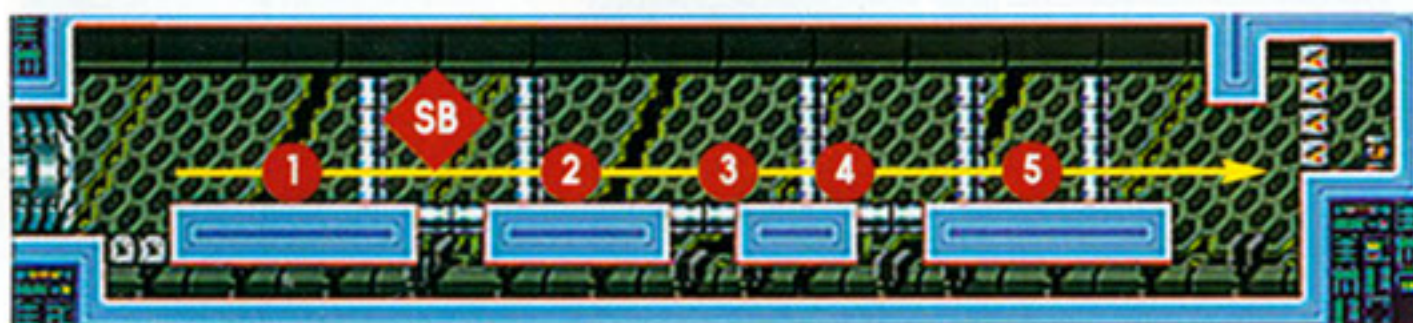
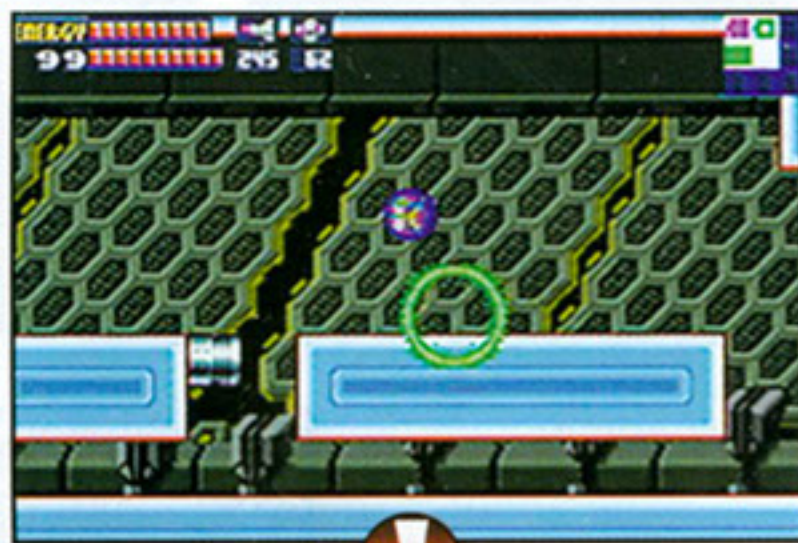

11 You'll reach the large area on the left side of Sector 6 by way of a Speed Booster-charged launch. As you enter the room, you'll fly along the line marked with a "1" on the map below, passing over a Power Bomb Tank. After you land, jump to the top of the room and move to the right side of the long path. Then run to the left to charge your Speed Booster, crouch to stop at the edge and drop, or use the Screw Attack, to position yourself just above the surface of the blocked walkway. Straighten out, press A then press Right. You'll soar over the path and grab the tank.

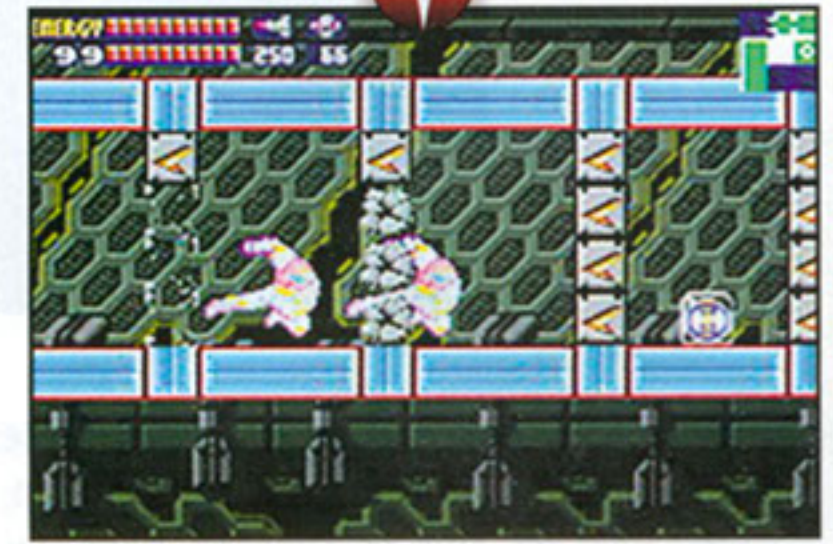
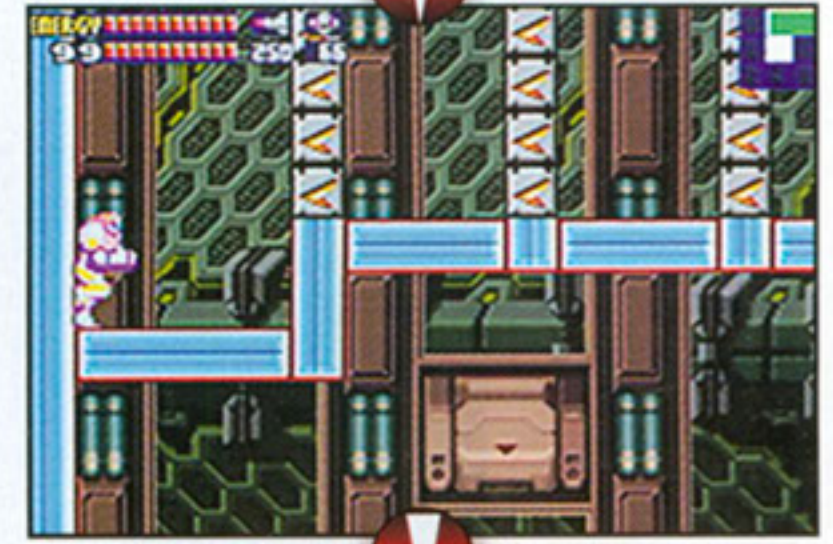
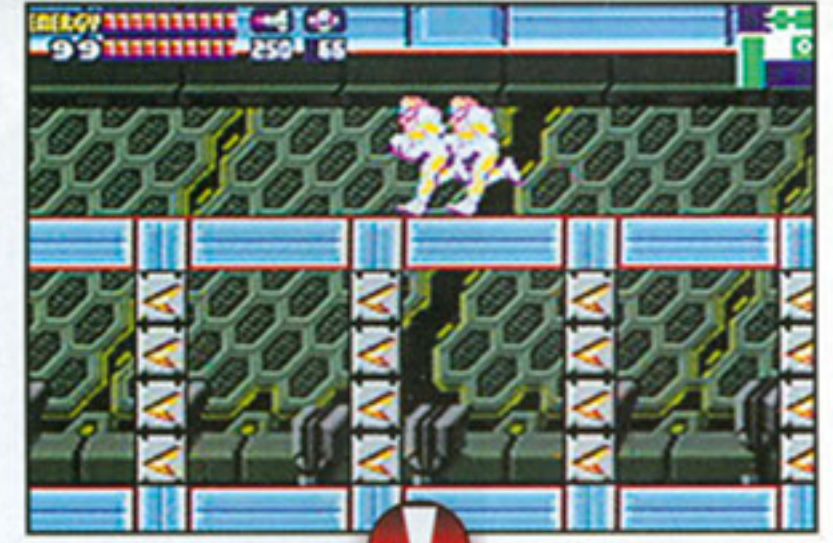

12 Nothing short of Speed Booster perfection will get you the Power Bomb Tank in the room's lower-left corner. Run along the floor, from left to right, to charge your booster. Stop then Space-Jump up and to the left. When you're almost over the Boost Block barrier that protects the tank, straighten out, press A, then press Down and Left on the Control Pad. You'll blast through the barrier. The map below shows your path.

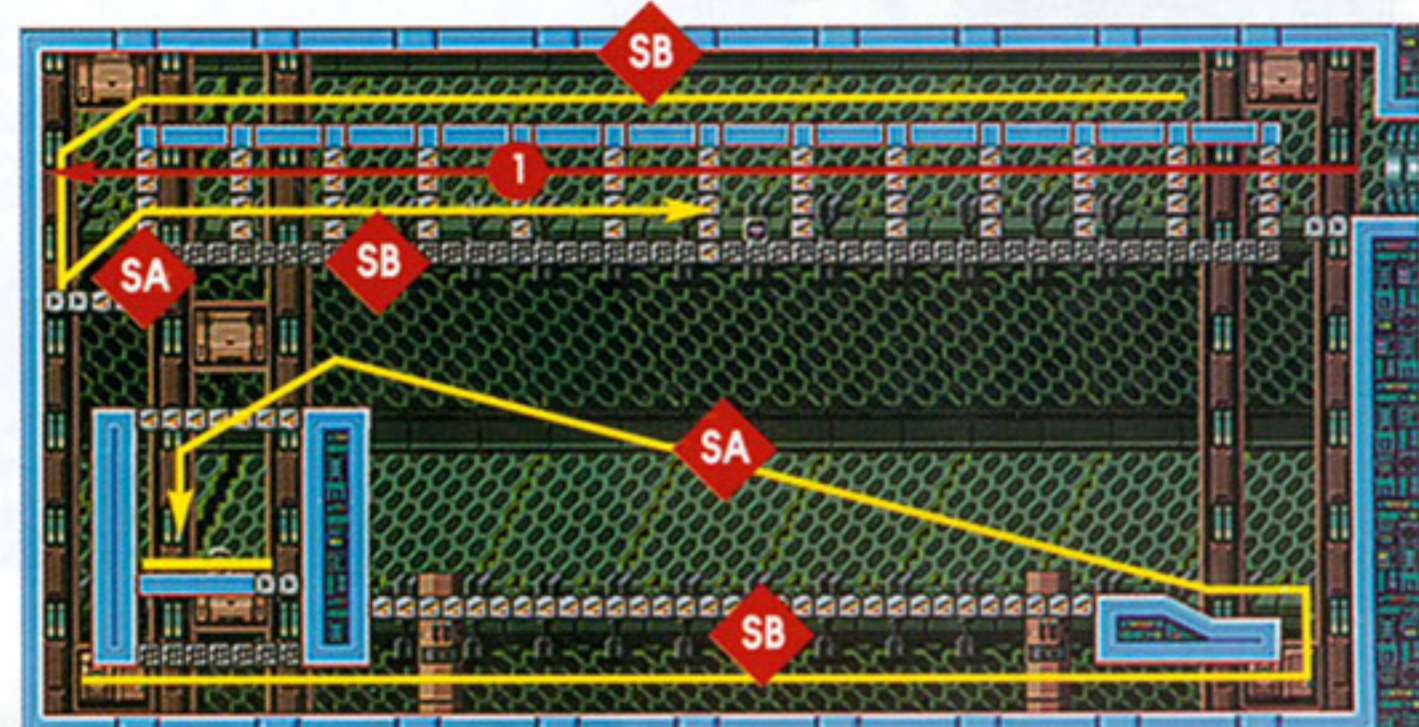
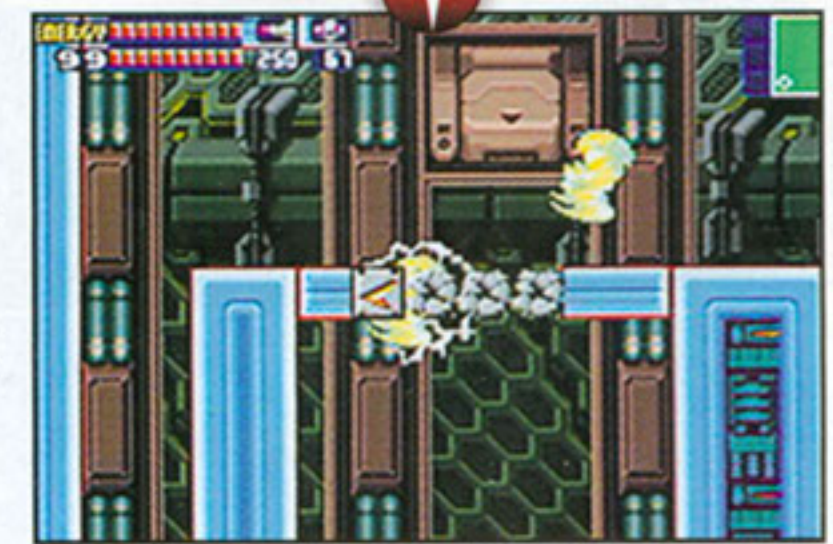

RESTRICTED ZONE  = 0/20  = 0/48  = 1/32

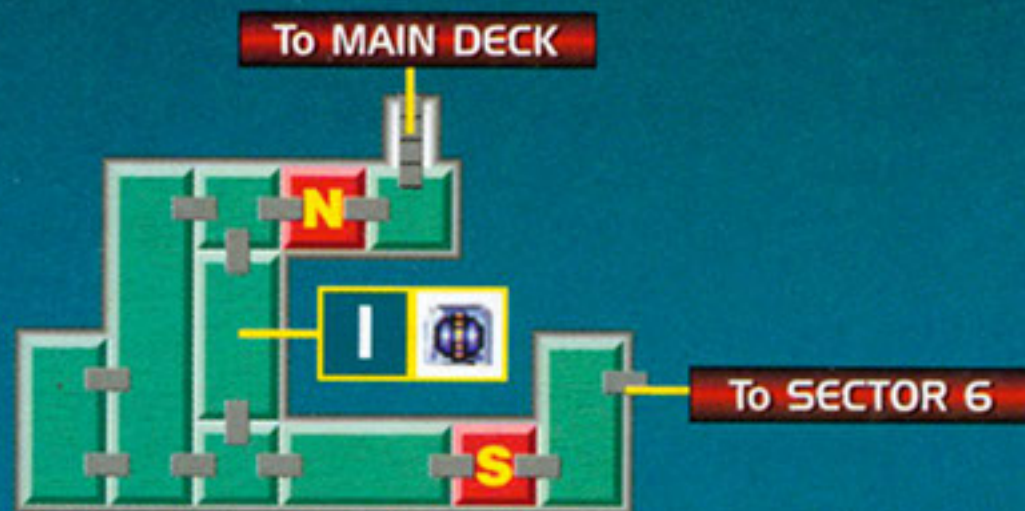

I After you have watched the Restricted Lab break away from the rest of the station, return to the lower part of the Restricted area by way of Sector 6. Charge up your Speed Booster as you approach the tunnel that once connected to the lab. Crouch to stop in the middle of the tunnel, then rocket up through a Boost Block barrier in the ceiling. You'll grab a Power Bomb Tank on your way to the upper tunnel.

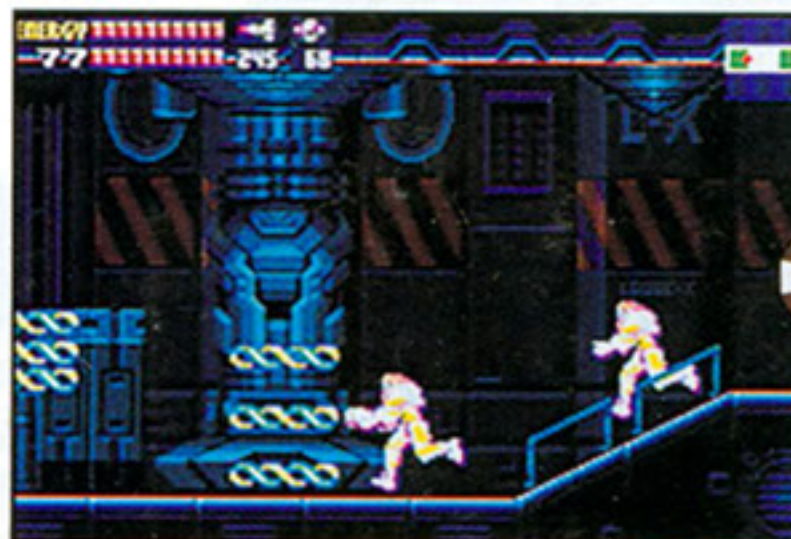

WATCH AND LEARN

You can pick up some adventuring pointers from Samus if you watch the game play demonstration that cycles with the title screen. Samus will show you all of her advanced moves and some areas where they are very useful.



Wait for a few moments, without touching any buttons, as the title screen displays. After a while, it will switch to a game play demonstration.



During the demonstration, you'll see all of Samus's moves, including the Speed Booster's charged-up rocket launch.

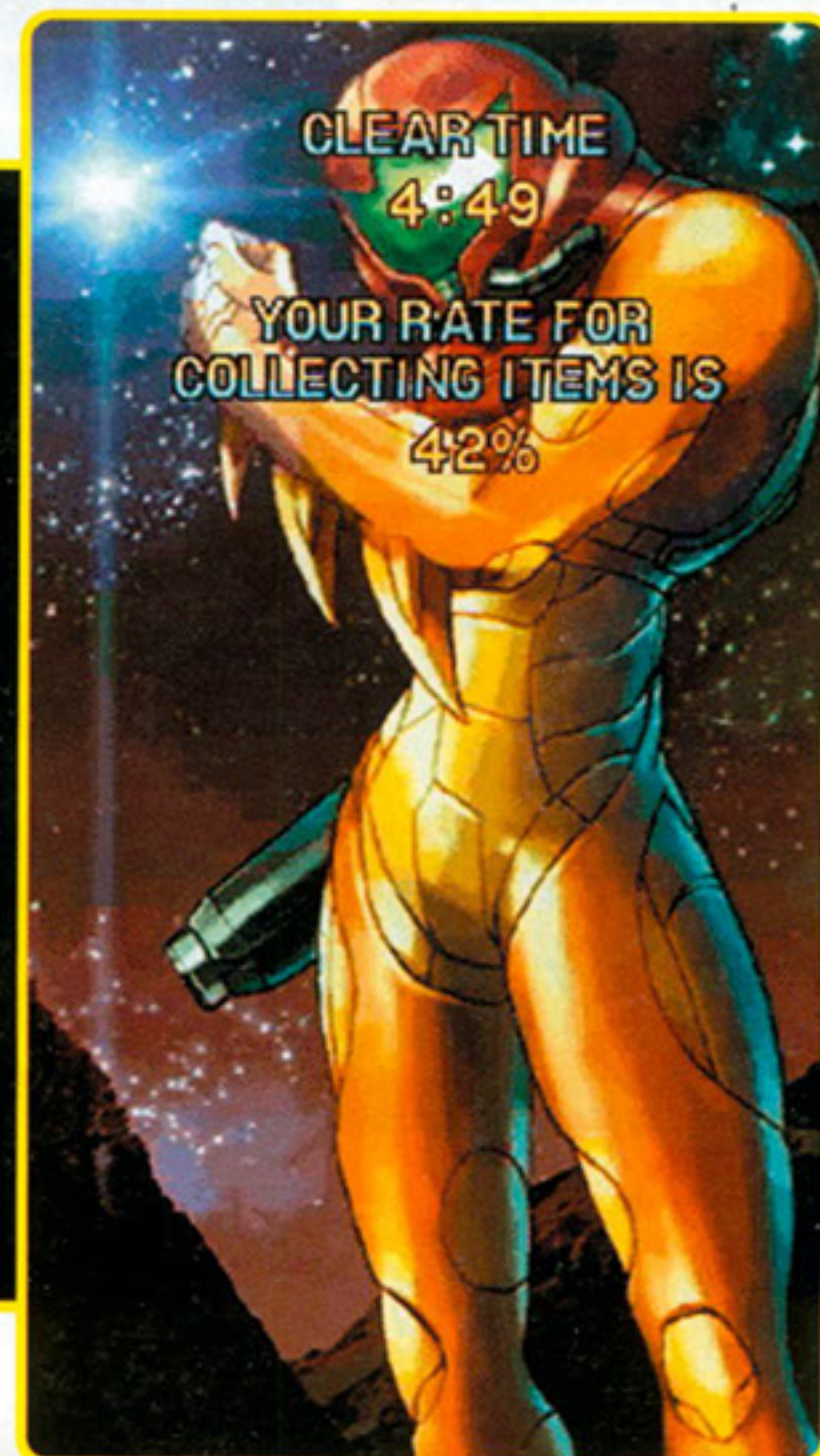

Expert Advice

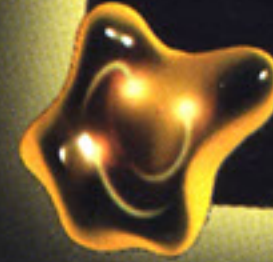
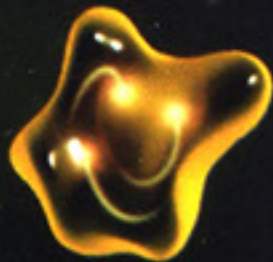
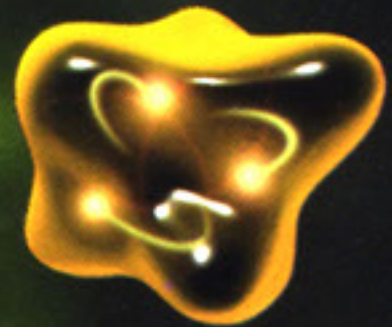

Energize Your Game

Samus Aran gets her power by absorbing X parasites. You can energize your adventuring efforts by subscribing to Nintendo Power—the official monthly source from Nintendo packed with strategies, codes and insider information for all your favorite Nintendo GameCube and Game Boy Advance games.



**12 Issues
for \$19.95!**

(\$27.95 Cdn.)



Have a Head for Strategy

The perfect capper for Samus Aran's Fusion Suit—get a free Metroid Fusion hat with your paid subscription to Nintendo Power. Ask for offer #4362 when you order the magazine and show your friends that you're a Fusion fan.

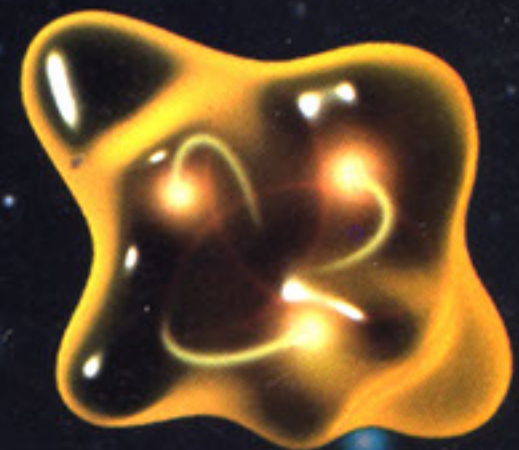

Visit nintendopower.com/subscribe

Or call 1-800-255-3700

Offer #4362

Please allow 4-6 weeks for delivery of the magazine and free gift. Online ordering not available in Canada. Offer good while supplies last. Prices subject to change without notice. Only Visa or MasterCard accepted with phone and online orders.







METROIDDATABASE.COM

BIG GAME!

Bounty hunter Samus Aran is after the X parasite that stole her identity. Crush the menace with help from the Official Nintendo Player's Guide!



-  Complete strategies for uncovering every secret and beating every boss
-  Details on how to earn all special abilities and game endings
-  Directions to Energy, Missile and Power Bomb Tanks—100 in all!
-  Huge, full-color maps that reveal every hidden passage and shortcut

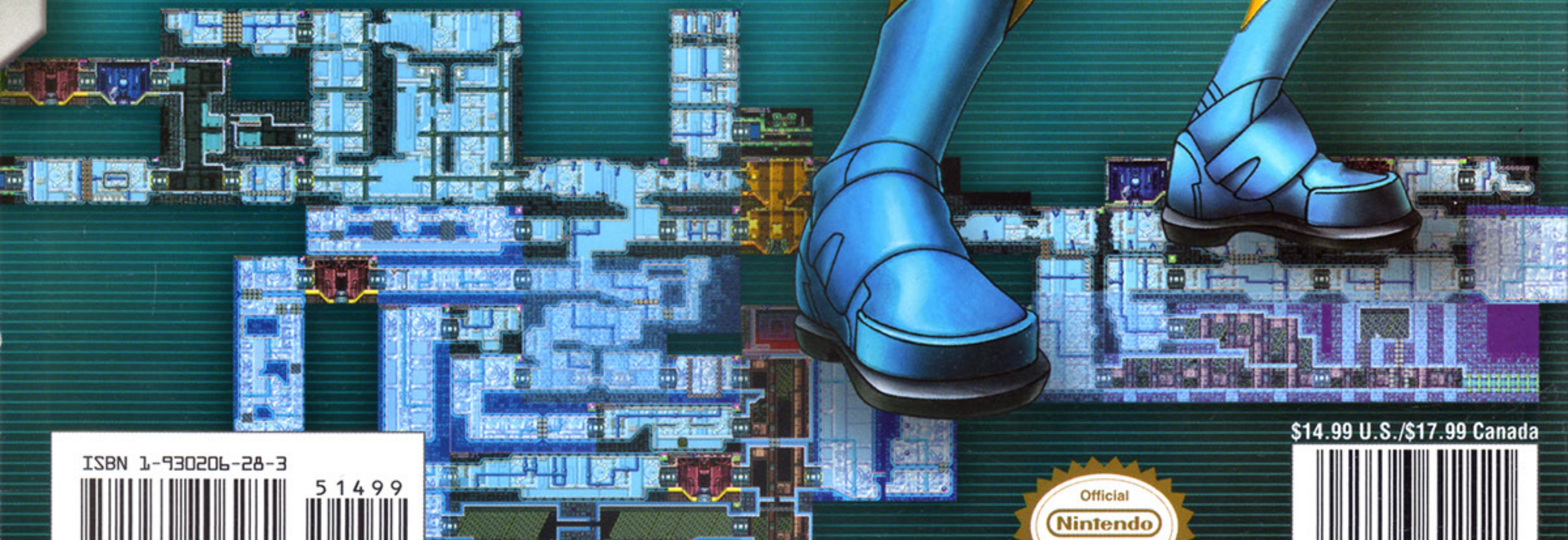

ISBN 1-930206-28-3



5 1499



9 781930 206281



\$14.99 U.S./\$17.99 Canada



0 45496 69242 1

MAP CONNECTIONS

You'll enter every sector for the first time by way of the Main Deck elevator. As you earn more abilities, you'll find hidden paths that connect each sector.

The paths are crucial for collecting all the items and completing the adventure quickly.

MAIN DECK

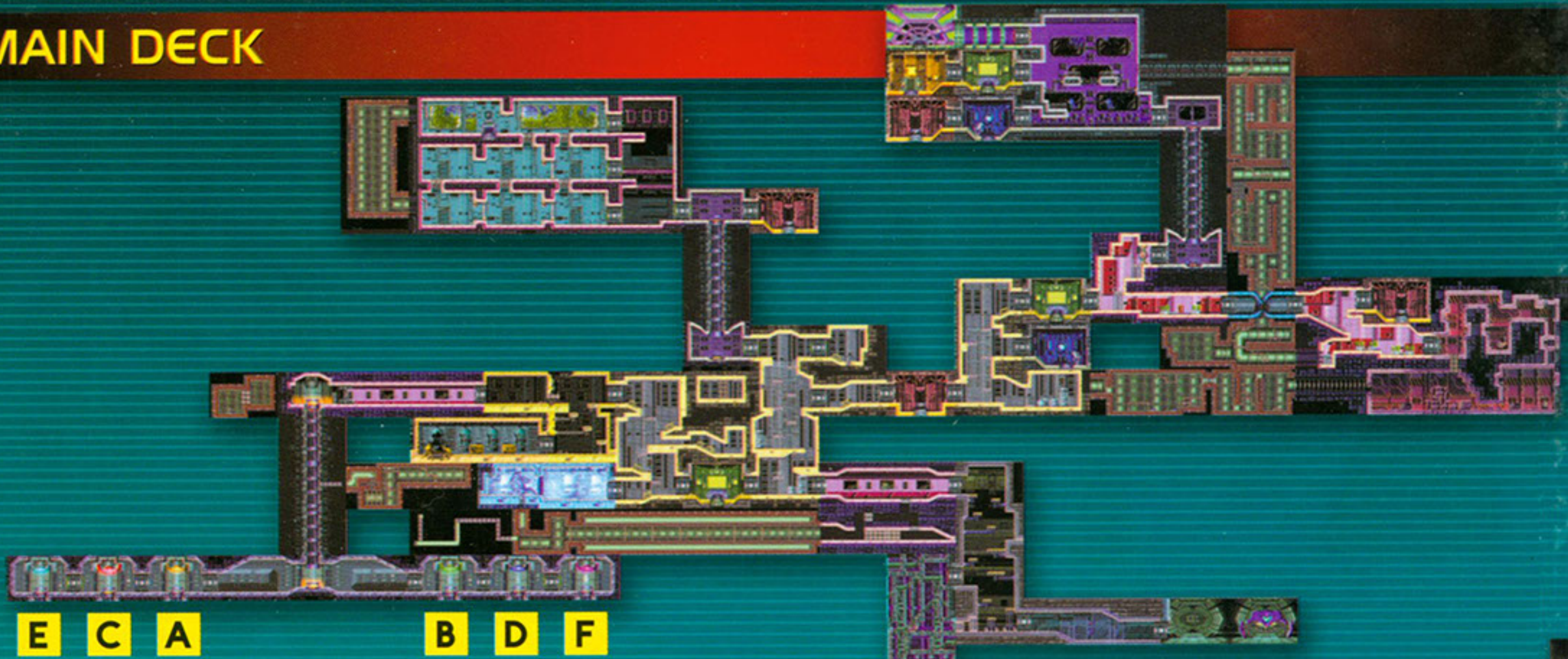

RESTRICTED ZONE



SECTOR 3

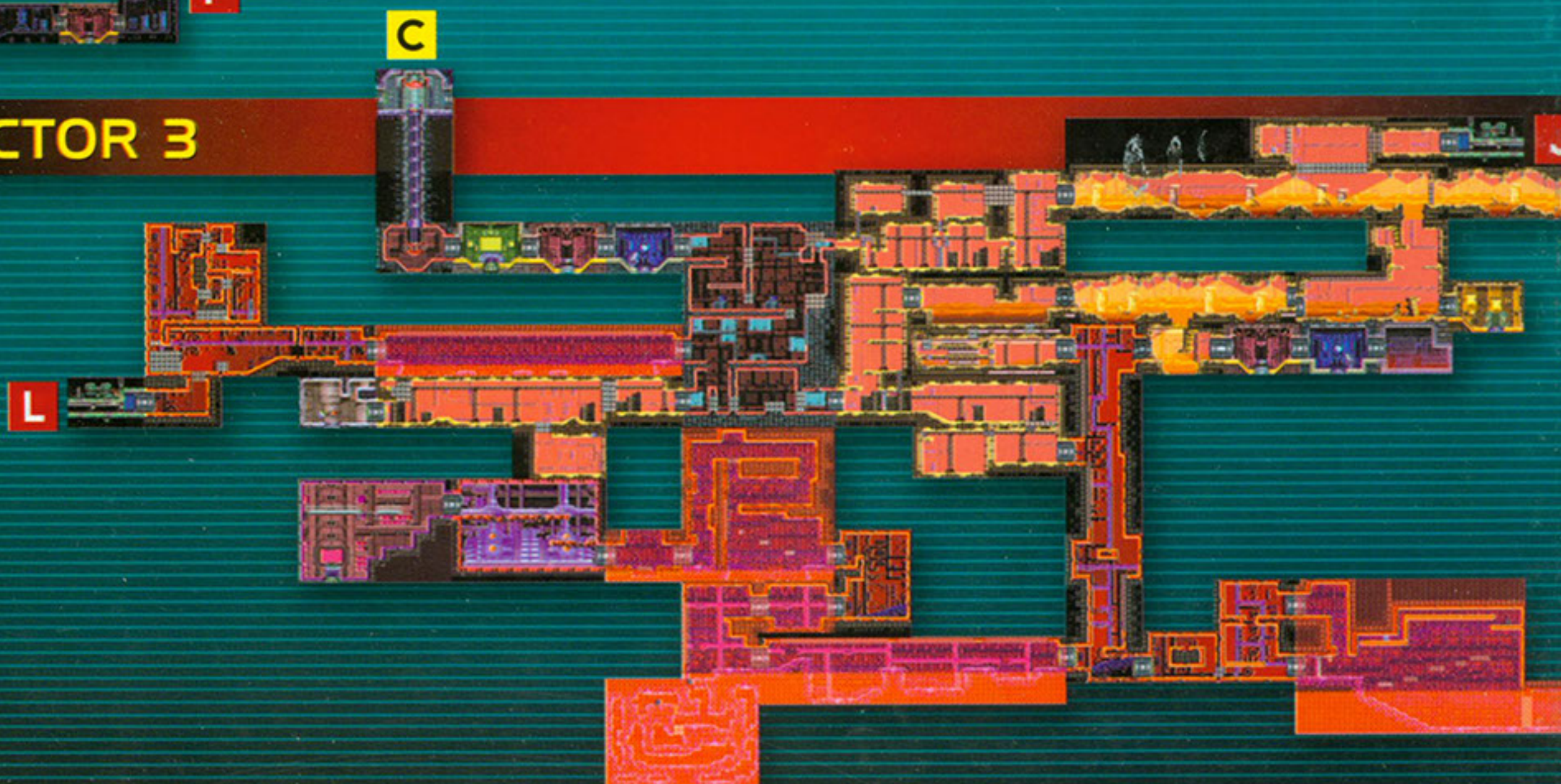

A

SECTOR I



J

I

G

E

SECTOR 4



D

O

N

M

K

SECTOR 6

F

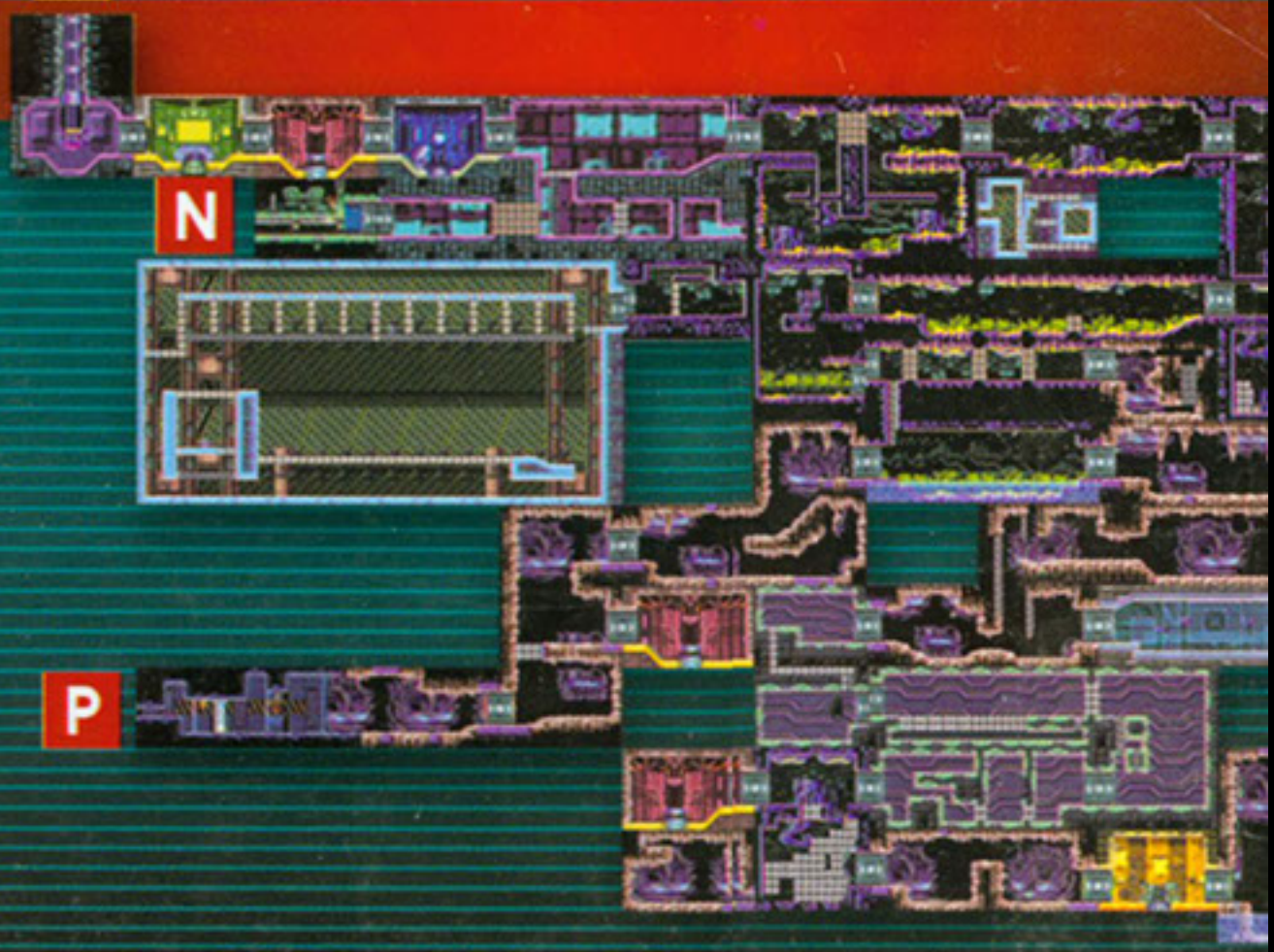

N



P

SECTOR 2



SECTOR 5



-  Elevators
-  Hidden Paths

On the maps in the X Adventure portion of this guide, only the sections that you can access during that particular visit are represented in full color. Areas you cannot reach on that visit appear in black.

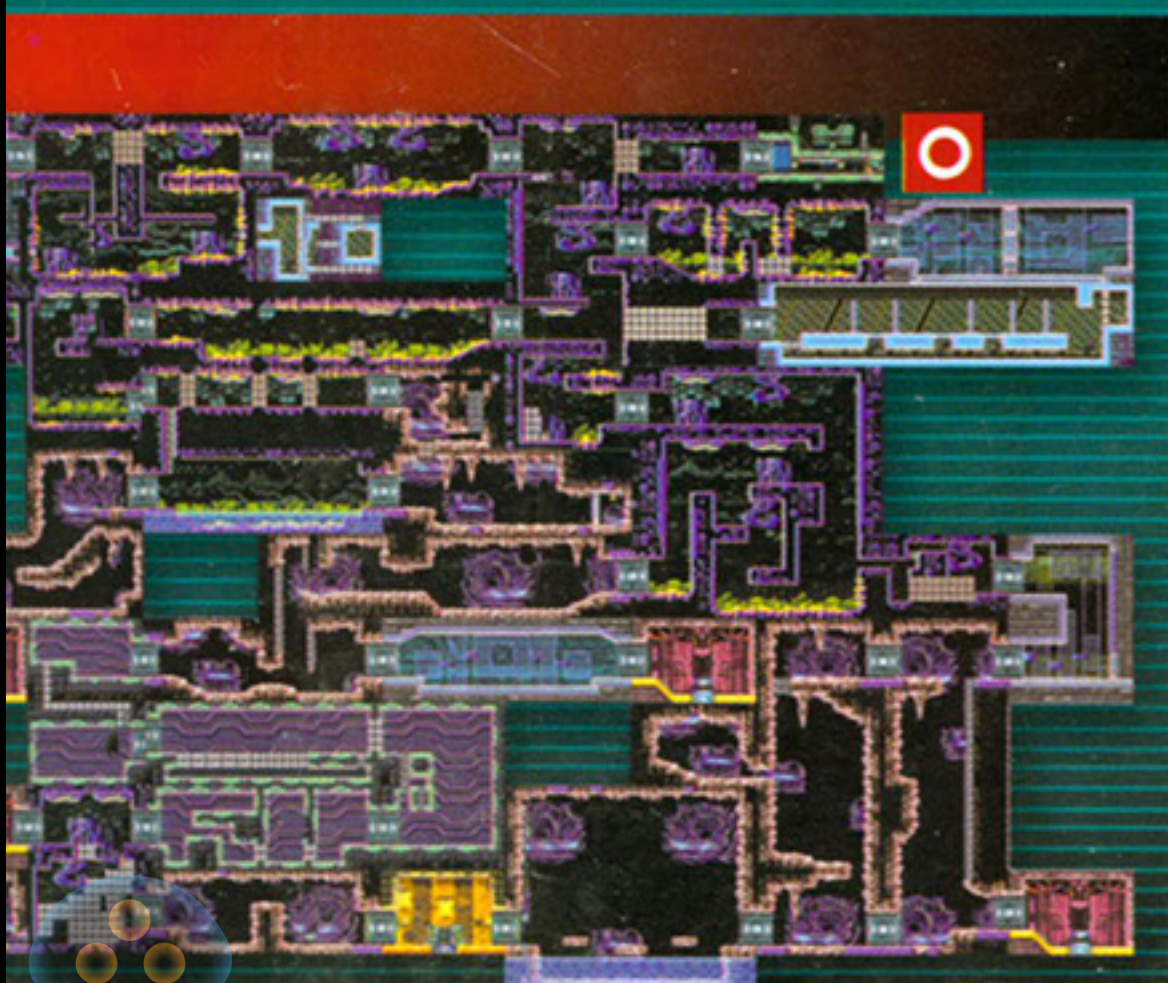

BIOLOGIC LABS RESE

Every sector and deck of the research station serves a different function. Some sectors maintain the operation of the stations. Others mimic the ecosystems of nearby planets.

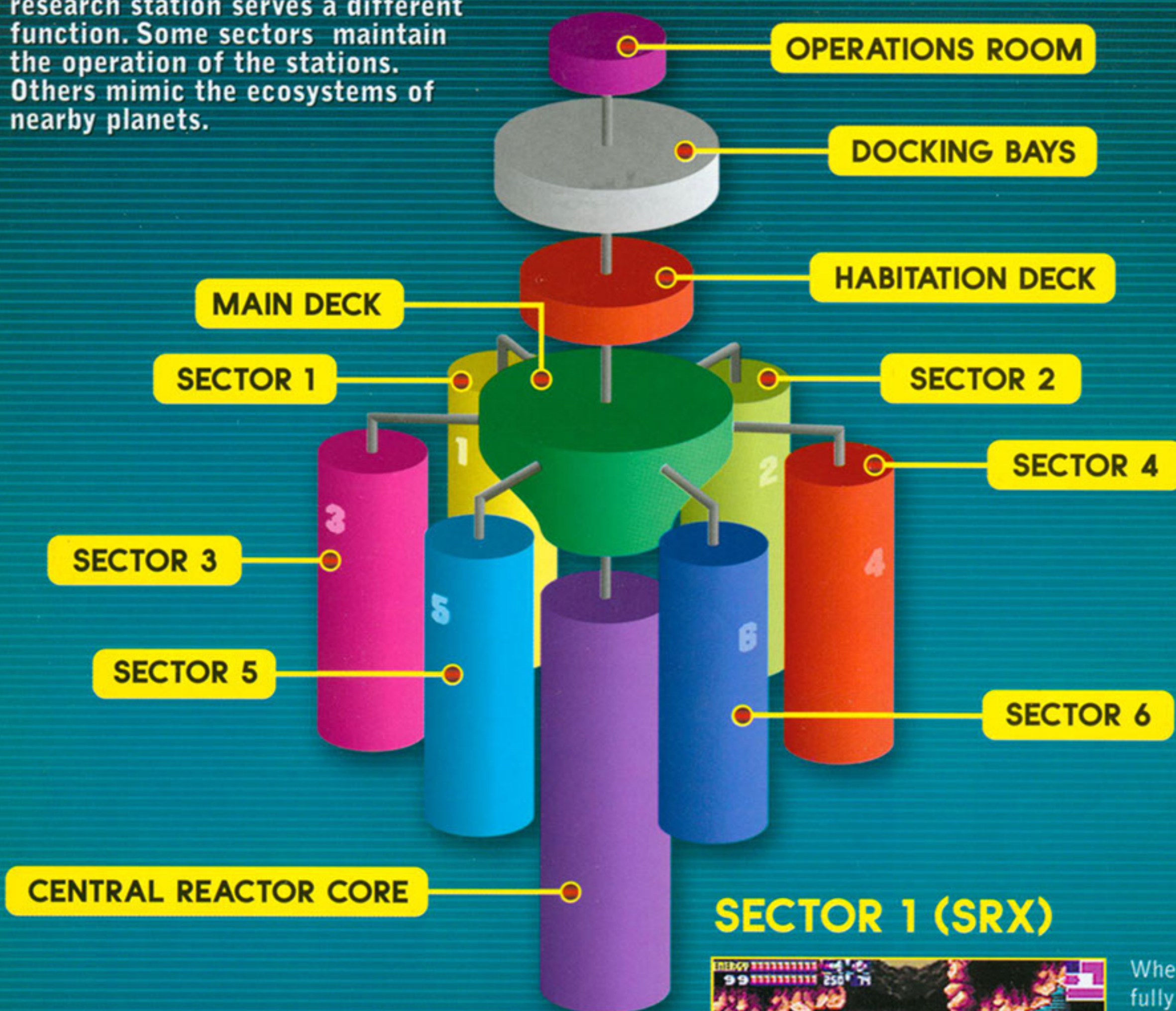

SECTOR 1 (SRX)



When the station was fully operational, the scientists were able to contain the X parasites in Sector 1 by maintaining an ecosystem similar to that of planet SR388.

SECTOR 4 (AQA)

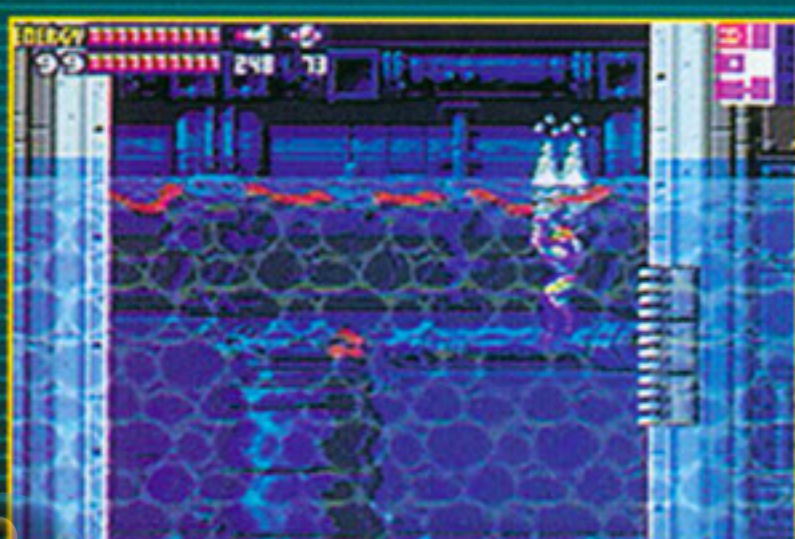

The oceanlike environment of Sector 4 holds several aquatic species. Until you have the Gravity Suit, you will not be able to move freely in the sector's water tanks.

SECTOR 5 (ARC)



The environments of Sector 5 are characterized by arctic temperatures and icy surfaces. Before you explore the sector, you must have the protection of the Varia Suit.

OPER

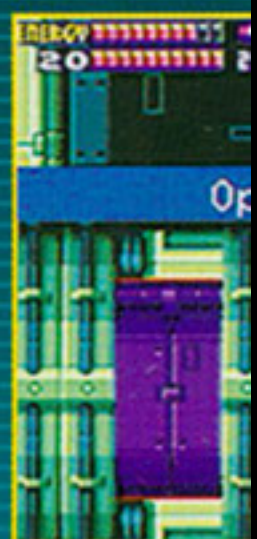

HABIT



SECTO

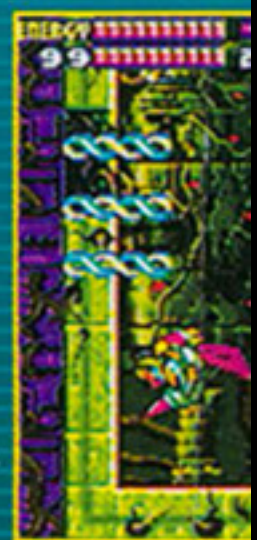

SECTO

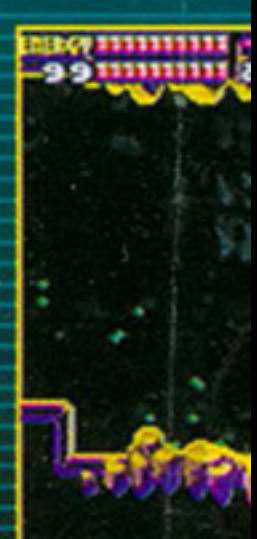

SEARCH STATION

SEARCH
You'll discover the station and to investigate

OPERATIONS ROOM



You'll visit the Operations Room at the beginning of your adventure to download data, and at the end to change the station's orbit. Level 4 security hatches protect the main controls.

DOCKING BAYS

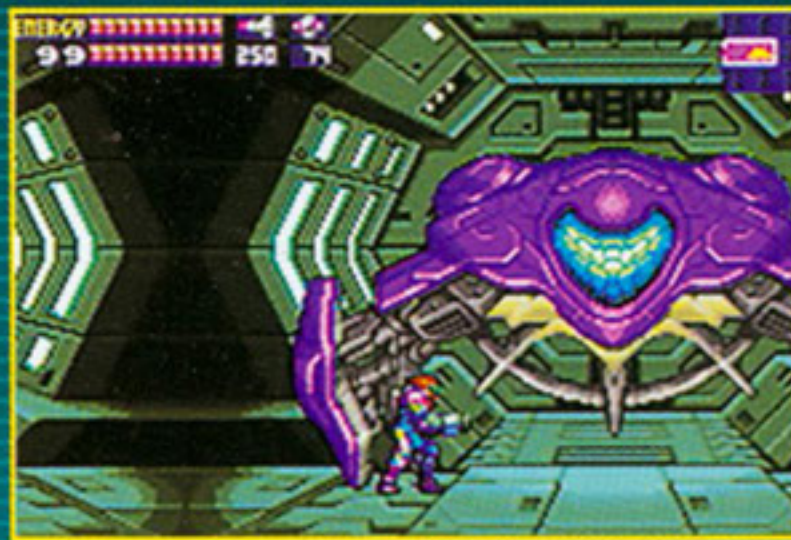

You can return to your ship in one of the station's Docking Bays at any time to refill your tanks and save your progress. It's also the site of a major battle.

BUILD YOUR

As you download data from the Core-X organisms through more battles, you were once unable to earn a new item. Now you'll find that you can access areas throughout the station to your tank collection.

HABITATION DECK

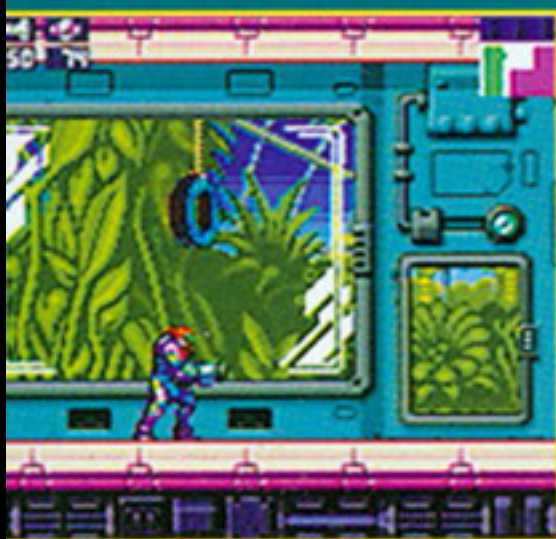

When the computer senses the presence of nonparasitic life-forms in the station, you'll make your way to the Habitation Deck and find some familiar creatures.

MAIN DECK



You'll fight your first battles on the station's Main Deck and pass through the area several times as you explore the station. The deck's elevator shafts reach every sector.

SOMERS

The last ability that you'll use is useful for station exploration. You'll have the Screw Attack. Use it in combination with the Screw Attack Block to fly through enemies and nearly anywhere in the station. Use the Screw Attack Block to blast through the walls and use the ability.

SECTOR 2 (TRO)



The tropical environment of Sector 2 is home to many exotic plants and creatures. Some of the sector's plants have grown roots into the station's electrical system.

SECTOR 3 (PYR)

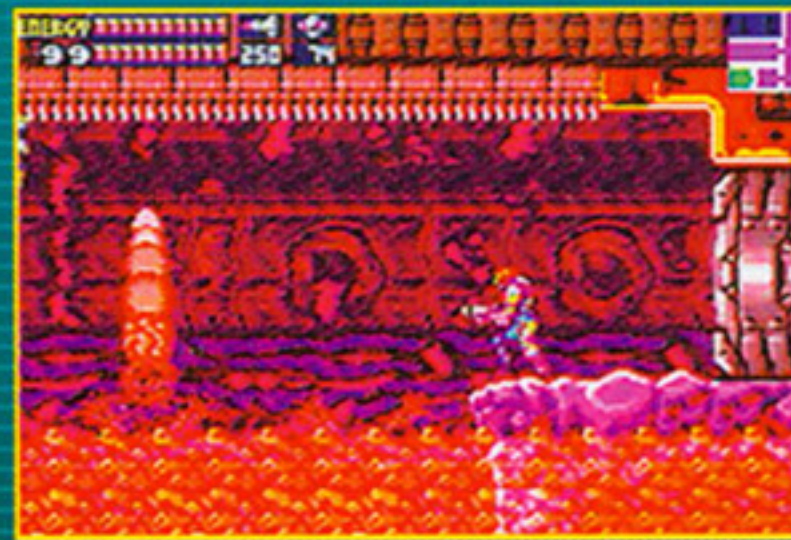

You won't find a place with higher temperatures than Sector 3, where the environment matches that of a planet's core. You'll need Varia Suit protection to explore some Sector 3 areas.

END EXPLORATION

Not long after you'll learn that you must make it crash into the Main Deck, you won't be able to access sectors. If you want to explore, you're still below the surface. You'll find hidden paths that connect the sectors.

SECTOR 6 (NOC)



The creatures that inhabit Sector 6 come out only at night, which is why it is always nighttime in the sector. As you explore the darkest sections, sometimes you'll have help from a localized light source.

CENTRAL REACTOR CORE



When the station's systems go offline, you'll begin your investigation of the problem in the Central Reactor Core, which you'll enter from the Docking Bays.



SEARCH THE STATION

You'll discover many creatures, tanks, suit abilities and surprises in the station's expansive areas. It pays to have an adventuring spirit and to investigate every section thoroughly.

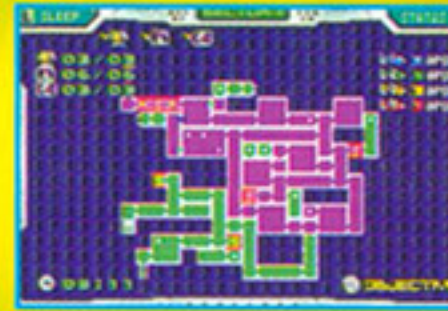

BUILD YOUR ABILITIES

As you download data and regain abilities from the Core-X organisms, you'll be able to break through more barriers and explore areas that you were once unable to enter. Every time you earn a new item or unlock a security level, you'll find that you can make discoveries in areas throughout the station and probably add to your tank collection.

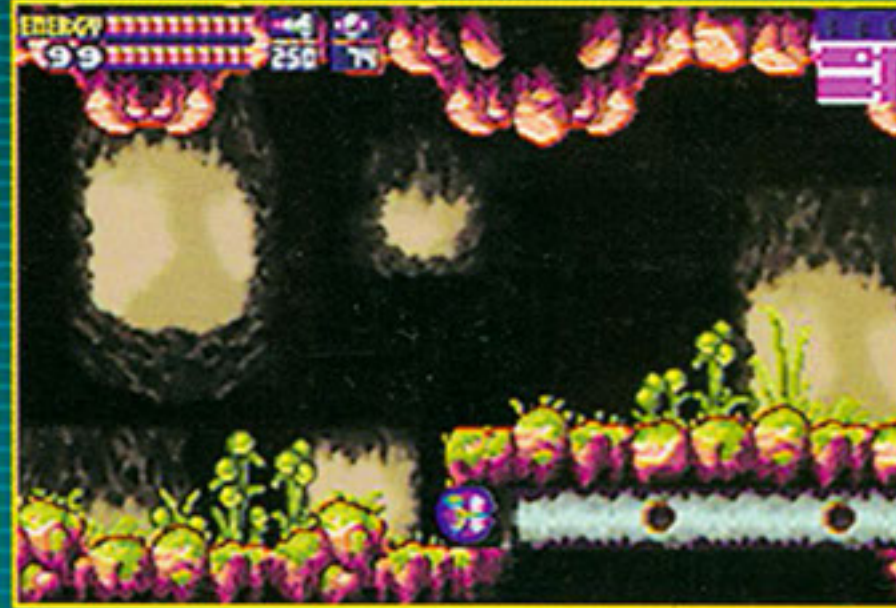

Exploration is key. You'll find a lot of small passages by rolling through areas in ball form.

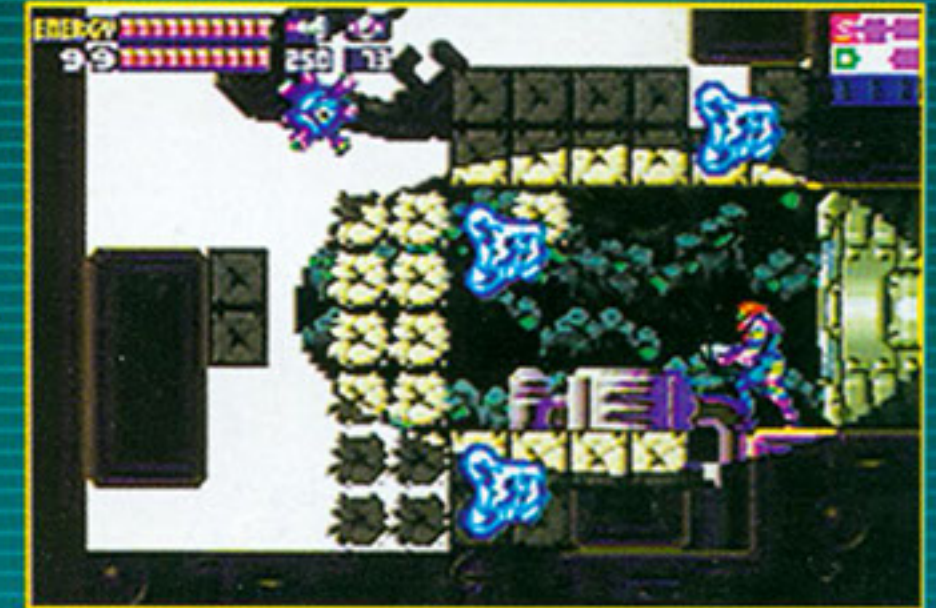

Power Bomb blasts affect objects in the immediate area—they break some blocks and expose others.

SOMERSAULT BREAKTHROUGH

The last ability that you will regain is the most useful for station exploration. When you finally have the Screw Attack back, you will be able to use it in combination with the Space Jump to fly through enemies and obstacles and go nearly anywhere in the station. Take note of the Screw Attack Blocks in the station and be sure to blast through those barriers once you have the ability.



After your battle with Ridley, you'll regain Samus's signature ability—the amazing Screw Attack.



Jump, fly and somersault through the station's sectors and corridors.

END EXPLORATION

Not long after you earn the Screw Attack ability, you'll learn that you must change the orbit of the station and make it crash into SR388. Once you return to the Main Deck, you won't be able to go back to any of the lower sectors. If you want to explore the station for items while you're still below the Main Deck, be sure to use the hidden paths that connect all of the sectors.



Main Deck



Sector 2 (TR0)

After you complete the adventure, you'll have the option to continue your exploration of the station in the same game file. When you return to the game, you'll discover that all of the hatches are open, giving you free reign over the entire station. After you've completed your exploration, you can fight the SA-X and the Omega Metroid again to see the version of the ending that you have earned.